



FOODSERVICE EQUIPMENT PRICE LIST

CANADIAN - AUGUST 1, 2025





People who serve,
products that solve.™

Hatco direct line for order support and inquiries: (414) 671-6350

How to Order

To ensure prompt and accurate processing of your order, please provide the following information:

1. Model number, voltage, Hertz and phase.
2. Specify options and accessories as required. Options are not retrofittable.
3. Consult factory when ordering equipment for special applications.
4. E-mail orders are acceptable and do not require confirmation.
5. See Resources section in back of book for more information.

ALL WATT RATINGS ARE NOMINAL. ACTUAL WATTAGE MAY VARY. CONSULT FACTORY FOR MORE INFORMATION.

E-mail orders to: equipsales@hatcocorp.com

E-mail inquiries and requests to: support@hatcocorp.com

Hatco Corporation
P.O. Box 340500
Milwaukee, WI 53234-0500
Telephone: (414) 671-6350
www.hatcocorp.com

Who We Are

Since 1950, Hatco has been a leader in creating innovative ideas for the foodservice industry: bold innovations in equipment that improve efficiency, reliability and profits. Products are designed and built to handle the rugged demands of today's foodservice operations. Hatco is a company dedicated to exceptional customer service and quality engineered equipment offering maximum performance.

We Pride Ourselves On Being Employee Owned

The company was started by Gordon and LaReine Hatch in 1950 and was led by their son, David, beginning in 1990. In 2004, Hatco Corporation began the journey of employee ownership and in 2007, a monumental event in Hatco history occurred: the employees assumed 100% ownership from David Hatch! Hatco still remains a family corporation - only now our family is larger. The employee owners are driven by the spirit of ownership and motivated by the empowerment of ownership.

Equipment

Booster Water Heaters	Dry Wells	Hot/Cold Shelves	Panini Grills
Buffet Warmers	Food Lockers	Hot/Cold Wells	Refrigerated Merchandisers
Carving Stations	Food Warmers	Hot Water Dispensers	Rethermalizers
Cold Shelves	Frost Tops	Ice Wells	Salamanders
Commercial Toasters	Fry Stations	Induction Griddle	Sanitizing Sink Heaters
Decorative Lamps	Heated Merchandisers	Induction Ranges	Sneeze Guards
Display Cabinets/Cases	Heated Shelves	Induction Warmers	Soup Wells
Display Lights	Heated Wells	Nacho Chip Warmers	Strip Heaters
Drawer Warmers	Holding Cabinets	Order Pickup Stations	Waffle Makers

Locations



Milwaukee - Corporate Office
635 South 28th St. | Milwaukee, WI 53215
414-671-6350



Sturgeon Bay - Manufacturing Facility
208 East Deck Street | Sturgeon Bay, WI 54235
920-743-5595





Table of Contents

ORDER PICKUP STATIONS & FOOD LOCKERS	2-10
HEATED & COLD WELLS	11-50
HEATED & COLD SHELVES	51-87
SNEEZE GUARDS	88-92
STRIP HEATERS	93-126
DECORATIVE LAMPS & DISPLAY LIGHTS	127-136
FRY STATIONS	137-143
CARVING STATIONS & BUFFET WARMERS	144-150

DRAWER WARMERS	151-156
MERCHANDISERS & DISPLAY CASES	157-190
HOLDING CABINETS	191-199
TOASTERS	200-206
INDUCTION RANGES & WARMERS	207-214
LIGHT COOKING EQUIPMENT	215-221
WATER HEATING/SPECIALTY EQUIPMENT	222-239
FOOD PANS & TRIVETS	240

3CS	224
3CS2	225
AWD	223
C	230-231
CDW	155
CHW	15, 39-40
CSBFR, CSBFX	81
CSBFP	77
CSSBR, CSSBX	79
CSSBFR, CSSBFX	80
CSSBFP	76
CSSBP	75
CSUR, CSUX	82-83
CSUP	78
CWBP, CWBP-S	41-43, 47
CWBR, CWBX, CWBR-S, CWBX-S	44-47
DCS, DCSB2	NEW 145
DHWBI, DHWBI-S	17-20, 39-40
DL, DLL, DLH	128-134
F2G, F2GB	5-6
F2GBOF, F2GBOB	NEW 4
F2GP, F2GBP	7-8
FDWD-1-MN	185
FDWD	180, 183-184
FR	226
FR2	227
FS2HAC	198
FS3HAC	159-160
FS3RAC	NEW 158
FSCD, FSCDH	176
FSD, FSDT	181-184
FSHAC, FSHACH	198
FSHC-5W, -7W	192
FSHC-6W	193
FSHC-7	194
FSHC-12W, -17W	195-196
FST-1-MN	185
FTBP, FTBP-S	84-85
FTBR, FTBR-S, FTBX, FTBX-S	86-87
FWM	219
GR2A, GR2AH	105, 107
GR2A-xxD, GR2AH-xxD	108-109
GR2AL, GR2AHL	106-107
GR2AL-xxD, GR2AHL-xxD	108-109
GR2BW	147-148
GR2S	57
GR2SDH, GR2SDS	166-167
GR3SDH, GR3SDS	171-172
GR3SDS-xxDCT, GR3SDS-xxTCT	173
GR5A, GR5AH	96, 98
GR5AL, GR5AHL	97-98

GR, GRH	100-101
GR-B	141-142
GRA, GRAH	99, 101
GRA-xxD, GRAH-xxD	102, 104
GRAL, GRAHL	100-101
GRAL-xxD, GRAHL-xxD	103-104
GRAIH, GRAIHL	117, 119
GRAIH-xxD, GRAIHL-xxD	118-119
GRAM, GRAML	110-111
GRAM-xxD	112, 114
GRAML-xxD	113-114
GRBW	147-148
GRCD, GRCDH	174-175
GRCMW	149
GRCSCCL, GRCSCCLH	146
GRFF, GRFFL, GRFFB, GRFFBL	141-142
GRFHS, GRFS	138-139
GRHD, GRHDH	177-178
GRHW	150
GRN, GRNH	115
GRNM	116
GRPWS	161-162
GRS2G	3
GRS	55-57
GRSB	66-67
GRSBF	68
GRSDH, GRSDS	164-165
GRSDS/H	163
GRSR	52, 54
GRSS	58
GRSSB	64
GRSSR, GRSSRxx-DL77516	53-54
HBG	59
HGBG	65
HCSBFR, HCSBFX	73-74
HCSSBR, HCSSBX	69-70
HCSSBFR, HCSSBFX	71-72
HCWBIR, HCWBIX	38-39
HDW	153-154
HDWTC	152
HDW-xR2	153-154
HGSM	60
HL	136
HL5	135
HRDW	156
HSBF-GL, -HC, -SS	61-63
HW	15, 39-40
HWB, HWBL, HWBH	28-32, 39-40
HWB-xxQT, HWBI-xxQT	28-29, 33-34, 39-40
HWBI, HWBLI	21-23, 27, 39-40
HWBI43	21, 24, 27, 39-40

HWBI-S	25-27, 39-40
HWBRN (UR)	28-29, 35-36, 39-40
HWBRT (UR)	28-29, 35-36, 39-40
HWBRN-xxQT (UR)	28-29, 37, 39-40
HWBRT-xxQT (UR)	28-29, 37, 39-40
HXMH, HXMS	168, 170
HZMH, HZMS	169-170
IGRID	NEW 216
IHDCH	188-189
IRNG-BXC1	208
IRNG-HC1, -PC1, -PB1	209-211
IRNG-PC2F, -PC2S, -PB2	212
IWELB	16
IWRM-C1, -CD1, -B1	213
IWRM-UT	214
IWB, IWB-S	48-50
ITQ	205
LFST	187
LW	143
MC	229
MDW	179
MPP	10
MPP-xPT, -xHPT	9
MPWS	140
PDH	190
PFST	197
PG14	NEW 218
PMG	228
PSH	190
PWB, PWC	199
RHW	13
RMB	126
RMB2	125
RWM	220
S	232-233
SAL	217
SNACK	221
SNEEZE GUARDS	89-92
SWB, SWC	12
SW2	14, 39
TK	206
TPT	201
TQ	202-203
TQ3	204
UGA, UGAH	120, 122
UGA-xxD, UGAH-xxD	121-122
UGAL, UGAHL	120, 122
UGAL-xxD, UGAHL-xxD	121-122
UGFF, UGFFL, UGFFB, UGFFBL	141-142
WFST	186

Order Pickup Stations & Food Lockers





Glo-Ray 2-Go® Heated Shelves

The Hatco Glo-Ray 2-Go® Heated Shelves are designed specifically with your delivery and carry-out needs in mind. Capable of holding a great quantity of hot food items at optimum serving temperatures, the GRS2G models hold bags and boxes up to 30 minutes with a high temperature range of up to 200°F.

- Shelves are 20" deep and 39" wide, large enough for pizza boxes and bags, which will easily fit into the 13" clearance of each shelf
- Touchscreen control with digital read out indicates separate heat and timer for each shelf
- Standard units feature shelves with heated bases that are thermostatically-controlled and have a stainless steel frame
- The cord is recessed into the bottom shelf at a 45° angle, allowing the unit to be flush against either wall



HEATED SHELVES

Model	Description	Dimensions W x D x H †	Voltage	Watts	Amps	Plug	Approx. Ship Weight	List Price
GRS2G-3920-2	2 heated shelves	43" x 20" x 21½"	120	704	5.6	NEMA 5-15P	150 lbs.	\$5594
GRS2G-3920-3	3 heated shelves	43" x 20" x 35¾"	120	1055	8.8	NEMA 5-15P	175 lbs.	6983
GRS2G-3920-4	4 heated shelves	43" x 20" x 50"	120	1406	11.7	NEMA 5-15P	200 lbs.	8366
GRS2G-3920-5	5 heated shelves	43" x 20" x 64¼"	120	1757	14.6	NEMA 5-20P	225 lbs.	9789

† Height does not include 1¾" side wall mounting brackets.

All Heated Shelf Models Feature:

Models shipped with: Side wall mounting brackets, 6" adjustable flanged feet that can be bolted to the floor for additional stability and a 6' recessed cord and plug.

Cord Location: Server side, bottom right corner.

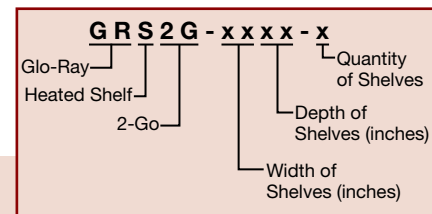

OPTIONS (available at time of purchase only)

Designer Colors – Non-standard colors are non-returnable – Stainless Steel standard –

RED	Warm Red	BLACK	Black	GRAY	Gray Granite	WHITE	White Granite	
NAVY	Navy Blue	GREEN	Hunter Green	COPPER	Antique Copper			\$748
CONTROL-GRS2G-R Controls and permanent panel on customers right side in lieu of standard left side								No Charge

Side Panels – will be same color as unit –

SPANEL	GRS2G2	Side panels for a 2-shelf unit	\$145
	GRS2G3	Side panels for a 3-shelf unit	292
	GRS2G4	Side panels for a 4-shelf unit	437
	GRS2G5	Side panels for a 5-shelf unit	581

Back Panels – will be same color as unit –

BPANEL	GRS2G2	Back panels for a 2-shelf unit	\$125
	GRS2G3	Back panels for a 3-shelf unit	248
	GRS2G4	Back panels for a 4-shelf unit	373
	GRS2G5	Back panels for a 5-shelf unit	499

ACCESSORIES (available for purchase at any time)

4"LEGS	4" Adjustable Legs (GRS2G-3920-2 and GRS2G-3920-3 models only)	Set of 4 \$98
--------	--	---------------

COLORS AND FINISHES – PAGE 241



Flav-R 2-Go® Built-In Outdoor Locker System

Boost efficiency and elevate the pickup experience with the Hatco Flav-R 2-Go® Built-In Outdoor Locker System. Featuring separate lockers for interior loading and exterior pickup, this innovative solution keeps orders moving and operations flowing. It streamlines order handoff by keeping ambient or hot meals secure, organized and ready for pickup. Staff load orders directly from the kitchen, while customers and delivery drivers pick them up outside — quickly, contact-free and without stepping indoors.



F2GBOF-7 shown from exterior customer side mounted into a building wall.



F2GBOB-7 Heated model shown from interior operator side with optional controls.

- Front and back lockers are sold separately for flexible pricing and installation options, and are designed to seamlessly join together to form a complete locker system
- Available in configurations of 7 or 11 cubbies to suit your needs
- Ambient holding is standard. Heated operation is available for F2GBOB models (interior operator side) only; heated models include individual thermostatic temperature controls for each cubby and support a temperature range from ambient to 200°F (93°C)
- Customer-facing touchscreen is rated for outdoor use, featuring a brighter display, thicker glass and anti-glare film
- 10" (257 mm) touchscreens on both customer and operator sides allow for quick, easy access
- Flashing LED lights will indicate the correct cubby for order pickup
- F2GBOF models (exterior customer side) feature insulated front doors, which shield against outdoor elements and maintain optimum temperatures in each cubby
- F2GBOB models (interior operator side) feature optional screen-printed glass doors for added privacy
- Adjustable mounting flanges accommodate wall thicknesses from 2" to 10" (51 to 254 mm)
- Heavy-duty outdoor-rated rotary latches, designed to meet IP65 rating, secure each cubby individually

FLAV-R 2 GO BUILT-IN OUTDOOR LOCKER SYSTEM (FRONT AND BACK MODELS)

Model	Dimensions (W x D x H)	Number of Lockers	Internal Dimensions (W x D x H)	Voltage	Watts	Amps	List Price
F2GBOF-7	39 ¹ / ₂ " x 14 ¹ / ₂ " x 73 ¹ / ₂ " (1003 x 368 x 1867 mm)	7	12" x 12" x 12" (305 x 305 x 305 mm)	120	15.6	1.3	\$31080
F2GBOB-7	39 ²¹ / ₅₀ " x 14 ¹ / ₂ " x 69 ¹ / ₂ " (1001 x 368 x 1765 mm)	7	12" x 12" x 12" (305 x 305 x 305 mm)	N/A	N/A	N/A	9862
F2GBOF-11	56 ¹ / ₂ " x 14 ¹ / ₂ " x 73 ¹ / ₂ " (1435 x 368 x 1867 mm)	11	12" x 12" x 12" (305 x 305 x 305 mm)	120	36	3.0	39014
F2GBOB-11	56 ²¹ / ₅₀ " x 14 ¹ / ₂ " x 69 ¹ / ₂ " (1435 x 368 x 1765 mm)	11	12" x 12" x 12" (305 x 305 x 305 mm)	N/A	N/A	N/A	12777

OPTIONS (available at time of purchase only)

Heated Operation – F2GBOB-07 and F2GBOB-11 Models (Interior Operator Side) Only –		
HEAT-7	Heated Operation for 7-Cubby Unit	\$1322
HEAT-11	Heated Operation for 11-Cubby Unit	2018
Glass Doors – F2GBOB-07 and F2GBOB-11 Models (Interior Operator Side) Only –		
GLASS-7	Glass Door for 7-Cubby Unit	2382
GLASS-11	Glass Door for 7-Cubby Unit	3742
Door Colors – F2GBOF-07 and F2GBOF-11 Models (Exterior Customer Side) Only –		
Non-standard door colors are non-returnable – Stainless Steel standard – BLACK		
		No Charge
Control Screen Location - All Models Row 3, Column 2 standard –		
CNTRLPANEL	Row 2, Column 2	No Charge
Cord Location - F2GBOB Heated Models Only – No Cord standard		
CORDLEFT	Bottom Left	No Charge
CORDRIGHT	Bottom Right	No Charge

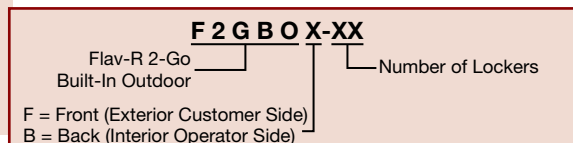



Flav-R 2-Go® Locker System

The Hatco Flav-R 2-Go® Countertop, Floor Mount, and Built-In Locker System conveniently holds multiple hot or ambient to-go food orders with quick and secure access. Customers and delivery drivers can arrive, access their specific locker and leave without waiting in line or disturbing the flow of business.

- Large 10" touchscreen for easy viewing (front and/or back)
- Lockers come preset to 150°F with a high temperature range up to 180°F
- Individual lockers can have the heat turned off for ambient storage
- Available in two locker depth sizes
- Available with pass-through or one-sided access (countertop or floor models only)
- Each locker has a timer that will hold prepared and packaged food for up to 45 minutes
- Customer side stays locked. When the access code is used, the door unlocks and LED lights flash in the appropriate locker



F2G-3-A
in optional *Designer Black*
(Customer side shown)

NOTE: This unit is intended for stationary indoor, commercial use only—NOT for mobile applications.

F2G-24-A
in standard *Designer Warm Red*
Red (Operator side shown)



COUNTERTOP AND FLOOR MOUNT LOCKER SYSTEM

Model	Number of Lockers	Model Dimensions W x D x H	Internal Locker Dimensions (W x D x H)	Voltage	Watts	Amps	Plug	List Price
Countertop								
F2G-22-A	4 Lockers	43 ⁵ / ₈ " x 14 ³ / ₄ " x 31 ³ / ₄ "	12" x 12" x 12"	120	423	3.8	NEMA 5-15P	\$25824
F2G-22-C	4 Lockers	43 ⁵ / ₈ " x 23 ¹ / ₄ " x 31 ³ / ₄ "	12" x 20 ¹ / ₂ " x 12"	120	551	4.8	NEMA 5-15P	26099
F2G-3-A	3 Lockers	61" x 14 ³ / ₄ " x 16 ⁵ / ₈ "	12" x 12" x 12"	120	321	2.9	NEMA 5-15P	21428
F2G-3-C	3 Lockers	61" x 23 ¹ / ₄ " x 16 ⁵ / ₈ "	12" x 20 ¹ / ₂ " x 12"	120	417	3.7	NEMA 5-15P	22107
F2G-32-A	6 Lockers	61" x 14 ³ / ₄ " x 31 ³ / ₄ "	12" x 12" x 12"	120	627	5.5	NEMA 5-15P	32565
F2G-32-C	6 Lockers	61" x 23 ¹ / ₄ " x 31 ³ / ₄ "	12" x 20 ¹ / ₂ " x 12"	120	819	7.1	NEMA 5-15P	33833
Floor Mount								
F2G-24-A	8 Lockers	45 ⁵ / ₈ " x 14 ³ / ₄ " x 71 ¹ / ₄ "	12" x 12" x 12"	120	831	7.3	NEMA 5-15P	\$41230
F2G-24-C	8 Lockers	45 ⁵ / ₈ " x 22 ⁷ / ₈ " x 71 ¹ / ₄ "	12" x 20 ¹ / ₂ " x 12"	120	1087	9.4	NEMA 5-15P	44563
F2G-34-A	12 Lockers	62 ¹ / ₄ " x 14 ³ / ₄ " x 71 ¹ / ₄ "	12" x 12" x 12"	120	1239	10.8	NEMA 5-15P	56519
F2G-34-C	12 Lockers	62 ¹ / ₄ " x 22 ⁷ / ₈ " x 71 ¹ / ₄ "	12" x 20 ¹ / ₂ " x 12"	120	1623	14.0	NEMA 5-20P	59815

All Locker System Models Feature:

Cord Location: Countertop Models: Operator side, bottom left.

Floor Models: Facing operator side, left side of unit bottom corner closest to operator side.

OPTIONS AND ACCESSORIES – PAGE 6

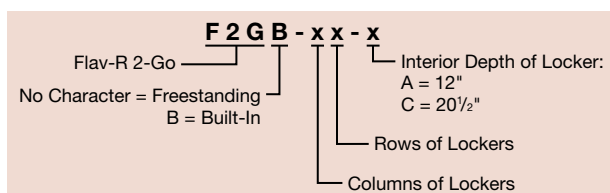



Flav-R 2-Go® Locker System continued



F2GB-22-A
in standard *Designer Warm Red* (Operator side shown)



F2GB-22-A
in optional *Designer Black* (Customer side shown)

BUILT-IN LOCKER SYSTEM

Model	Number of Lockers	Model Dimensions W x D x H	Internal Locker Dimensions (W x D x H)	Voltage	Watts	Amps	Plug	List Price
Built-In								
F2GB-22-A	4 Lockers	41 1/4" x 14 3/4" x 34 3/4"	12" x 12" x 12"	120	423	3.8	NEMA 5-15P	\$25917
F2GB-22-C	4 Lockers	41 1/4" x 23 1/4" x 34 3/4"	12" x 20 1/2" x 12"	120	551	4.8	NEMA 5-15P	27051
F2GB-23-A	6 Lockers	41 1/4" x 14 3/8" x 49 5/8"	12" x 12" x 12"	120	627	5.5	NEMA 5-15P	33541
F2GB-23-C	6 Lockers	41 1/4" x 22 7/8" x 49 5/8"	12" x 20 1/2" x 12"	120	819	7.1	NEMA 5-15P	34713
F2GB-3-A	3 Lockers	61" x 14 3/4" x 20"	12" x 12" x 12"	120	321	2.9	NEMA 5-15P	22556
F2GB-3-C	3 Lockers	61" x 23 1/4" x 20"	12" x 20 1/2" x 12"	120	417	3.7	NEMA 5-15P	23554
F2GB-32-A	6 Lockers	61" x 14 3/4" x 34 3/4"	12" x 12" x 12"	120	627	5.5	NEMA 5-15P	33541
F2GB-32-C	6 Lockers	61" x 23 1/4" x 34 3/4"	12" x 20 1/2" x 12"	120	819	7.1	NEMA 5-15P	34713
F2GB-33-A	9 Lockers	61" x 14 3/4" x 49 5/8"	12" x 12" x 12"	120	933	8.2	NEMA 5-15P	44218
F2GB-33-C	9 Lockers	61" x 23 1/4" x 49 5/8"	12" x 20 1/2" x 12"	120	1221	10.6	NEMA 5-15P	46065
F2GB-42-A	8 Lockers	77 3/4" x 14 3/4" x 34 3/4"	12" x 12" x 12"	120	831	7.3	NEMA 5-15P	41296
F2GB-42-C	8 Lockers	77 3/4" x 23 1/4" x 34 3/4"	12" x 20 1/2" x 12"	120	1087	9.4	NEMA 5-15P	43245
F2GB-43-A	12 Lockers	77 3/4" x 14 3/4" x 49 5/8"	12" x 12" x 12"	120	1239	10.8	NEMA 5-15P	58012
F2GB-43-C	12 Lockers	77 3/4" x 23 1/4" x 49 5/8"	12" x 20 1/2" x 12"	120	1623	14.0	NEMA 5-20P	59165
F2GB-52-A	10 Lockers	94 5/8" x 14 3/4" x 34 3/4"	12" x 12" x 12"	120	1035	9.1	NEMA 5-15P	50534
F2GB-52-C	10 Lockers	94 5/8" x 23 1/4" x 34 3/4"	12" x 20 1/2" x 12"	120	1355	11.7	NEMA 5-15P	51908

All Locker System Models Feature:

Cord Location: Built-In Models: Operator side, bottom left

OPTIONS (available at time of purchase only)

Designer Colors – Warm Red standard –

BLACK	Black	GRAY	Gray Granite	WHITE	White Granite	
NAVY	Navy Blue	GREEN	Hunter Green	COPPER	Antique Copper	No Charge
CNTRLPANEL_RIGHT						Right side control panel, in lieu of standard left side location (F2G-3, F2G-32, F2G-34, F2GB-3, F2GB-32, F2GB-52 and F2GB-33 models only) No Charge

Back Panels – Creates a non-pass-through unit – will be same color as unit – Not available on Built-In models –

COUNTERTOP: The cord and power switch will move to the side of the unit, operators left, if right side is not selected at time of order. Subtract 15/16" to the depth and add 1 1/8" to width.

FLOOR MOUNT: The cord and power switch will move to the side of the unit, operators left, if right side is not selected at time of order. Subtract 15/16" to the depth and add 1 1/8" to width.

BPANEL3	Back panels in lieu of glass door for F2G-3 models	\$ -661
BPANEL4	Back panels in lieu of glass door for F2G-22 models	-882
BPANEL6	Back panels in lieu of glass door for F2G-32 models	-1322
BPANEL8	Back panels in lieu of glass door for F2G-24 models	-1763
BPANEL12	Back panels in lieu of glass door for F2G-34 models	-2644
RGHTCRDLOCATION	Cord location moves to operator side, right lower corner, in lieu of standard operator side, left lower corner	No Charge
QR1	QR Code Reader for non-pass-through units. Must be combined with Back Panels	1836
QR2	QR Code Reader for pass-through units	3672

ACCESSORIES (available for purchase at any time)

ANTI-TIPBRACKT	Wall Mount Bracket (mounting hardware not included) (Floor Mount Non Pass-Through models only)	\$147
----------------	---	--------------

COLORS AND FINISHES – PAGE 241



Flav-R 2-Go® Pizza Locker System

The Hatco Flav-R 2-Go® Floor Mount, Built-In, and Countertop Pizza Locker System - designed specifically for your pick-up and third-party delivery needs, is capable of holding multiple orders of hot or ambient pizza with quick and secure access. By reducing congestion and allowing employees to focus on other functions, customers or delivery people can arrive, access their specific locker, and leave without waiting in line or disturbing the flow of other business.

- A great solution to handling pick-up, third-party delivery and to-go orders in a non-contact manner
- Individual lockers can have the heat turned off for ambient storage
- Each locker unit has a large 10" touchscreen on the operator side and on the customer side. The operator puts in the name and code. The customer receives the code, enters it on the customer side, and the appropriate door unlocks.
- As a pass-through unit, customer side stays locked. When the access code is used, the door unlocks and opens for 30 seconds
- Available in *Designer* colors



F2GP-12-C
in standard *Designer* Warm Red (Customer side shown)



F2GP-14-C
in standard *Designer* Warm Red (Customer side shown)

COUNTERTOP AND FLOOR MOUNT PIZZA LOCKER SYSTEM

Model	Number of Lockers	Model Dimensions W x D x H	Internal Locker Dimensions (W x D x H)	Voltage	Watts	Amps	Plug	List Price
Countertop								
F2GP-12-C	4 Lockers	44 ¹ / ₈ " x 24 ⁷ / ₈ " x 31 ³ / ₄ "	20 ⁷ / ₈ " x 4 ²⁹ / ₃₂ " x 20 ¹ / ₂ "	120	536	4.7	NEMA 5-15P	\$33455
F2GP-21-C	4 Lockers	77 ⁷ / ₈ " x 24 ⁷ / ₈ " x 16 ⁷ / ₈ "	20 ⁷ / ₈ " x 4 ²⁹ / ₃₂ " x 20 ¹ / ₂ "	120	536	4.7	NEMA 5-15P	\$33455
F2GP-22-C	8 Lockers	77 ³ / ₄ " x 24 ⁷ / ₈ " x 31 ³ / ₄ "	20 ⁷ / ₈ " x 4 ²⁹ / ₃₂ " x 20 ¹ / ₂ "	120	1057	9.2	NEMA 5-15P	\$4070
Floor Mount								
F2GP-14-C	8 Lockers	44 ¹ / ₈ " x 24 ⁷ / ₈ " x 71 ¹ / ₄ "	20 ⁷ / ₈ " x 4 ²⁹ / ₃₂ " x 20 ¹ / ₂ "	120	1057	9.2	NEMA 5-15P	\$56456

All Pizza Locker System Models Feature:

Cord Location: Countertop Models: Operator side, right corner.
Floor Models: Operator side, right corner.

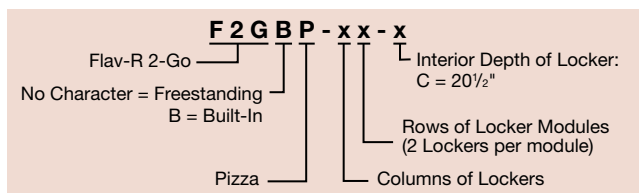



Flav-R 2-Go® Pizza Locker System continued



F2GBP-12-C
in standard
Designer
Warm Red
(Customer
side shown)

BUILT-IN PIZZA LOCKER SYSTEM

Model	Number of Lockers	Model Dimensions W x D x H	Internal Locker Dimensions (W x D x H)	Voltage	Watts	Amps	Plug	List Price
Built-In								
F2GBP-12-C	4 Lockers	44 ¹ / ₈ " x 24 ⁷ / ₈ " x 34 ³ / ₄ "	20.8" x 4.9" x 20.5"	120	536	4.7	NEMA 5-15P	\$35882
F2GBP-14-C	8 Lockers	44 ¹ / ₈ " x 24 ⁷ / ₈ " x 64 ³ / ₈ "	20.8" x 4.9" x 20.5"	120	1057	9.2	NEMA 5-15P	55795
F2GBP-21-C	4 Lockers	77 ³ / ₄ " x 24 ⁷ / ₈ " x 19 ¹⁵ / ₁₆ "	20.8" x 4.9" x 20.5"	120	536	4.7	NEMA 5-15P	35882
F2GBP-22-C	8 Lockers	77 ³ / ₄ " x 24 ⁷ / ₈ " x 34 ³ / ₄ "	20.8" x 4.9" x 20.5"	120	1057	9.2	NEMA 5-15P	55795

All Pizza Locker System Models Feature:

Cord Location: Built-In Models: Operator side, bottom left corner.

OPTIONS (available at time of purchase only)

Designer Colors – Non-standard colors are non-returnable – Warm Red standard –

BLACK	Black	GRAY	Gray Granite	WHITE	White Granite	
NAVY	Navy Blue	GREEN	Hunter Green	COPPER	Antique Copper	No Charge
CNTRLPANEL_RGHT	Right side control panel, in lieu of standard left side location (F2GP-12-C and F2GBP-12-C models only)					No Charge
RGHTCRDLOCATION	Cord location moves to operator side, right lower corner, in lieu of standard operator side, left lower corner					No Charge
QR2	QR Code Reader for pass-through units					\$3672

ACCESSORIES (available for purchase at any time)

ANTI-TIPBRACKT	Wall Mount Bracket (mounting hardware not included) (Floor Mount Non Pass-Through models only)	\$147
-----------------------	---	--------------

COLORS AND FINISHES – PAGE 241

NOTE: This unit is intended for stationary indoor, commercial use only—NOT for mobile applications.



Pass-Through Pickup Pod™

Hatco's heated or ambient Pass-Through Pickup Pod™, propelled by Minnow™, helps automate customer and delivery pickups. As a pass-through unit, the operator can easily fill orders from the back of the house to help streamline the delivery process, and customers and delivery people simply access their reserved cubbies by scanning the QR code or using the embedded link sent via SMS. All of this is done without waiting in line or needing to ask for help from front of house staff.

- Available in either heated or ambient styles with eight unit pods
- Heated units are thermostatically controlled with an operational range of 140°F to 185°F
- Heated pods may also be operated in Ambient Mode
- Offers customers and delivery workers a touchless experience via their own devices with QR code and SMS messaging
- Energy-saving 5000K LED cubby lighting showcases food
- Each individual cubby is 13¹⁹/₃₂" W x 20⁴¹/₆₄" D x 14¹/₂" H
- The antimicrobial surfaces and touchless interface work in tandem to inhibit the spread of bacteria, mildew and germs
- Plug into a standard 120V outlet and units are ADA compliant
- Has rear door handles which allow for minimal contact and easy access
- Connects via Cellular, WiFi, or CAT-5/6

MPP-8HPT
Operator side shown



MPP-8HPT
Customer side shown



PASS-THROUGH PICKUP POD

Model	Number of Lockers	Model Dimensions (W x D x H)	Internal Locker Dimensions (W x D x H)	Voltage	Watts	Amps	Plug	Approx. Ship Weight	List Price
Ambient									
MPP-8PT	8 Lockers	32 ⁷ / ₃₂ " x 24" x 80 ¹⁷ / ₃₂ "	13 ¹⁹ / ₃₂ " x 20 ⁴¹ / ₆₄ " x 14 ¹ / ₂ "	120	90	0.4	NEMA 5-15P	390 lbs.	\$27687
Heated									
MPP-8HPT	8 Lockers	32 ⁷ / ₃₂ " x 24" x 80 ¹⁷ / ₃₂ "	13 ¹⁹ / ₃₂ " x 20 ⁴¹ / ₆₄ " x 14 ¹ / ₂ "	120	1424	11.87	NEMA 5-15P	390 lbs.	\$34282

All Pass-Through Pickup Pod Models Feature:
Cord Location: Operator side, bottom left.

OPTIONS (available at time of purchase only)

Designer Colors – Charcoal standard –

BRONZE	Bronze	No Charge
PVCWHITE	White	No Charge

NOTE: SaaS (software as a service) fees are required for each unit. Contact factory for future details and requirements.

SaaS fees enables cloud connectivity, user interface and data analytics.

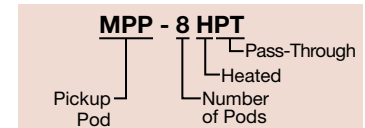
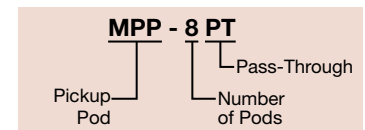



Pickup Pod™

Hatco's Pickup Pod™ propelled by Minnow™, help automate customer and delivery pickups. A self-service, touchless pickup solution that reduces lobby/dining area congestion, eliminates pickup mistakes, reduces labor costs, and improves the takeout experience for all. Customers and delivery people simply access their reserved cubbies by scanning the QR code or using the embedded link sent via SMS. All without waiting in line or needing to ask for help from front of house staff. And unlike unsecure tables, The Hatco Pickup Pod keeps food fresh and secure until it's ready to be picked up.

- Pickup Pod offers customers and delivery workers a touchless experience via their own devices with QR code and SMS messaging.
- Touchless interface prevents spreading of germs
- Energy-saving 5000K LED cubby lighting showcases food
- Ambient individually insulated cubbies
- Configurable pick-up times help ensure food safety
- Antimicrobial surfaces inhibit the growth of bacteria mold and mildew
- Each cubby is a spacious 13³/₄" W x 14¹/₂" D x 15" H
- Plugs into a standard 120V outlet
- Includes wall mounting bracket to keep unit stable (MPP-8I unit only)

- Connects via Cellular, WiFi, or CAT-5/6
- ADA compliant
- Customer notification sent via SMS Messaging or other methods via POS or App integrations (by others)
- Lily Pad base available to help stabilize units that cannot be fastened to the wall. Can be used in lieu of wall mounting brackets[Ⓞ] (MPP-8I unit only)



MPP-8I in standard Charcoal

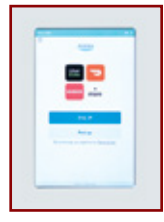

Optional touchscreen tablet

NOTE: SaaS (software as a service) fees are required for each unit. Contact factory for future details and requirements.

SaaS fees enables cloud connectivity, user interface and data analytics.

PICKUP POD

Model	Number of Lockers	Model Dimensions W x D x H	Internal Locker Dimensions (W x D x H)	Voltage	Watts	Amps	Plug	Approx. Ship Weight	List Price
MPP-8I	8 Lockers	31 ⁷ / ₈ " x 16" x 77 ³ / ₄ "	13 ³ / ₄ " x 14 ¹ / ₂ " x 15"	120	90	.75	NEMA 5-15P	350 lbs.	\$19076

All Pickup Pod Models Feature:
Cord Location: Center, back of unit.



MPP-8I Shown in optional PVC White with accessory MPP-PAD2-61[Ⓞ]



MPP-PAD2-57[Ⓞ]



MPP-PAD2-58[Ⓞ]

OPTIONS (available at time of purchase only)

Designer Colors – Charcoal standard –

BRONZE	Bronze	No Charge
PVC WHITE	White	No Charge
TOUCHSCREEN	NEW Optional Touchscreen Tablet	\$3372

ACCESSORIES (available for purchase at any time for MPP-8I model only)

MPP-PAD2-57 [Ⓞ]	(Charcoal Color) 37.5" H x 25.5" W Lily Pad to stabilize free-standing units. Can only be used in lieu of wall mounting hardware.	\$712
MPP-PAD2-58 [Ⓞ]	(Bronze Color) 37.5" H x 25.5" W Lily Pad to stabilize free-standing units. Can only be used in lieu of wall mounting hardware.	712
MPP-PAD2-61 [Ⓞ]	(PVC White Color) 37.5" H x 25.5" W Lily Pad to stabilize free-standing units. Can only be used in lieu of wall mounting hardware.	712

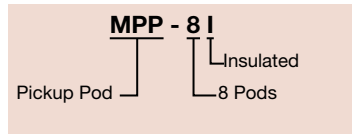

[Ⓞ] Not UL approved component. In order to satisfy UL safety standards, the MPP-8I must be secured to a wall. The Lilypad may be used for stabilization in a freestanding installation, however, it will not satisfy the UL standard for safety in lieu of securing it to a wall. Please contact us if you have any questions.

Heated & Cold Wells





Dry Soup Wells

Hatco's Dry Soup Wells offer a plumbing-free solution for rethermalizing or holding food at safe temperatures. Both the built-in and countertop units offer the same intuitive user interface, four customizable presets and six preset temperatures to make the Dry Soup Well a simple and effective solution.

- Gentle, even heating without the need for water
- Features an intuitive, interactive user interface
- Adjustable stir timers indicate when it's time to stir
- Automatically transfers from rethermalization to hold
- Features a screen lock to keep anyone else from tampering with the controls
- Includes pan with hinged lid



Quick-Ship Program Information Inside Back Cover

DRY SOUP WELLS

Model	Item #	Color	Dimensions [^] (W x H)	Voltage	Watts	Amps	Plug	Ship Weight*	List Price
Countertop									
✓ SWC-7QT	SWC7QTC515	Clear Coat	12 ² / ₅ " x 11 ¹ / ₂ "	120	425	3.5	NEMA 5-15P	14 lbs.	\$1968
✓ SWC-7QT	SWC7QTB515	Bold Black	12 ² / ₅ " x 11 ¹ / ₂ "	120	425	3.5	NEMA 5-15P	14 lbs.	1968
✓ SWC-11QT	SWC11QTC515	Clear Coat	14 ² / ₅ " x 11 ¹ / ₂ "	120	675	5.6	NEMA 5-15P	17 lbs.	2147
✓ SWC-11QT	SWC11QTB515	Bold Black	14 ² / ₅ " x 11 ¹ / ₂ "	120	675	5.6	NEMA 5-15P	17 lbs.	2147
Built-In									
✓ SWB-7QT	SWB7QT515	None	10 ³ / ₅ " x 10 ³ / ₅ "	120	425	3.5	NEMA 5-15P	14 lbs.	\$1847
✓ SWB-11QT	SWB11QT515	None	12 ² / ₅ " x 10 ³ / ₅ "	120	675	5.6	NEMA 5-15P	17 lbs.	2147

* Shipping weight includes packaging.

[^] Dimensions only include the unit without the pan and lid.

All Dry Soup Well Models Feature:

Cord Location: Rear right bottom.

ACCESSORIES (available for purchase at any time)

Pans –

7QT-PAN	7-Quart Round Pan	\$204
11QT-PAN	11-Quart Round Pan	225

Lids –

7QT-LID	7-Quart Round, Hinged and Notched Lid	\$149
7QT-LID-1	7-Quart Round, Notched, Solid Lid	106
11QT-LID	11-Quart Round, Hinged and Notched Lid	186
11QT-LID-1	11-Quart Round, Notched, Solid Lid	127

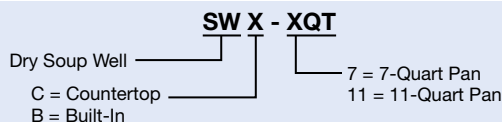



Round Heated Wells

The multipurpose dry Heated Well from Hatco offers the flexibility of foodwarmers, soup kettles, Bain-Marie heaters, steamers and pasta cookers all in one! With a range of temperature settings, this unit can boil pasta and soup noodles, steam dim sum and warm and hold soups, curry, gravies and toppings at safe serving temperatures.

- Three temperature setpoints from 122°F to 212°F for warming, steaming and boiling
- Low power mode allows energy efficiency
- Single built-in model available (one 11-quart round pan)
- Freestanding units available as a single (one 11-quart round pan) or dual model (two 11-quart round pans) with individually-controlled pans



RHW-1B includes one RHW pan, lid and remote control (ladle not included)



RHW-1 includes one RHW pan and lid



RHW-2 includes two RHW pans and lids (lids not shown)

Heated & Cold Wells

Quick-Ship Program Information Inside Back Cover

FREESTANDING ROUND HEATED WELLS

Model	Dimensions W x D x H	kW	Voltage Single Phase	Plug	Approx. Ship Weight	List Price
✓ RHW-1	14 ⁷ / ₁₆ " x 13" x 14"	1.3	120	NEMA 5-15P	20 lbs.	\$1566
✓ RHW-2	24 ⁷ / ₁₆ " x 13" x 14"	2.0-2.7	208-240	NEMA 6-15P	36 lbs.	2424

All Freestanding Round Models Feature:

Liquid Capacity: RHW-1: 11-quart round pan (actual pan capacity: 6³/₄ quarts for boiling application or 8¹/₂ quarts for warming application).

RHW-2: 2 x 11-quart round pans (actual pan capacity: 2 x 6³/₄ quarts for boiling application or 2 x 8¹/₂ quarts for warming application).

RHW-1 Shipped with: One food holding pan and one pan lid.

RHW-2 Shipped with: Two food holding pans and two pan lids.

Cord Location: 72" cord and plug, back of unit.

Quick-Ship Program Information Inside Back Cover

BUILT-IN ROUND HEATED WELL

Model	Dimensions W x D x H	kW	Voltage Single Phase	Plug	Approx. Ship Weight	List Price
✓ RHW-1B	14 ³ / ₁₆ " x 13" x 13 ¹ / ₁₆ "	1.3	120	NEMA 5-15P	21 lbs.	\$1464

All Built-In Round Models Feature:

Liquid Capacity: 11-quart round pan (actual pan capacity: 6³/₄ quarts for boiling application or 8¹/₂ quarts for warming application).

RHW-1B Shipped with: One food holding pan, one pan lid and remote control.

Cord Location: 56" cable from well to control box with a 6' cord and plug located at the back of the control box.

Recommended Well Cut-Out Size: 11¹/₁₆" diameter.

ACCESSORIES (available for purchase at any time)

RHW-11QT-LID-HG	RHW Hinged Lid for 11-Quart Round Pan	\$163
RHW-11QT-POT	RHW 11-Quart Round Pan	215

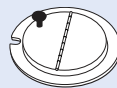

RHW-11QT-LID-HG
Hinged lid for 11-quart round pan

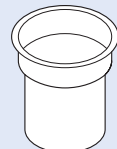

RHW-11QT-POT
11-quart round pan

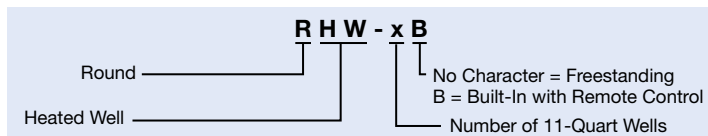



Soup Stations

Hatco's Soup Station is designed to provide an attractive appearance while holding pre-heated soups at safe-serving temperatures – whether it's front of the house, self-serve kiosks or catering.

Heat is evenly distributed throughout the unit to hold foods at optimum temperatures, and the insulated stainless steel design provides easy maintenance and durable performance.

- Unit available to accommodate two 7-quart or two 11-quart round pans
- Stainless steel construction with insulation that provides easy maintenance and durable performance

- Infinite switch with indicator light on both ends of unit controls nearest well
- Convenient recessed handles
- Comes with 6' cord and plug attached



SW2-11QT



SW2-7QT in optional Designer color

SOUP STATIONS

Model	Dimensions W x D x H	Voltage Single Phase	Watts	Plug	Approx. Ship Weight	List Price
SW2-7QT	25½" x 15¾" x 10¾"	120	750	NEMA 5-15P	34 lbs.	\$2361
SW2-11QT	25½" x 15¾" x 10¾"	120	750	NEMA 5-15P	53 lbs.	2430

All Soup Station Models Feature:

Models Shipped with: Two heating elements, indicator light, infinite switch and controls located at each end of unit.
Cord Location: Back of unit.

OPTIONS (available at time of purchase only)

Designer Color – Non-standard colors are non-returnable –		
SS	Base unit in Stainless Steel (standard)	No Charge
BLACK	Base unit in Designer Black	\$335
Upper Shelf with LED Lights – (includes a Reversible Back that fits Magnetic Graphics [not included] or reverse for a Sign Holder to insert your custom signage) – Non-standard colors are non-returnable –		
SW2-US-LED	Stainless Steel (Standard) – add 7/8" to depth, 16¼" to height	\$1073
SW2-US-LED-BK	Designer Black – add 7/8" to depth, 16¼" to height	1176



SW2-US-LED Upper shelf with LED lights and reversible back for magnetic graphics or reverse for a sign holder to insert your custom signage

ACCESSORIES (available for purchase at any time)

Reversible Back – (fits Magnetic Graphics [not included] or reverse the back for a Sign Holder to insert your custom signage) – Non-standard colors are non-returnable –		
SW2-BACK	Reversible Back (includes posts) in Stainless Steel, graphic not included (add 13½" to height and 7/8" to depth)	\$467
SW2-BACK-BK	Reversible Back (with posts) in Designer Black, graphic not included (add 13½" to height and 7/8" to depth)	565

SW2-BACK Reversible back (with posts) in Stainless Steel, fits magnetic graphics (not included) or reverse the back for sign holder to insert your custom signage



Reversible back with back splash shown



Reversible back with signholder shown

SW2-4.5RAIL
Cup rail accessory



Cup Rail –		
SW2-4.5RAIL	Cup Rail in Stainless Steel (add 4½" to depth)	\$145
SW2-4.5RAIL-BK	Cup Rail in Designer Black (add 4½" to depth)	176

Magnetic Graphics (for Base and Reversible Back) –		
SW2-BASEGRPHCS	Magnetic Base Graphics (covers 3 sides - front and both sides of Soup Station)	\$413
SW2-BACKSGRPHC	Magnetic Back Graphic (Backsplash Graphic Area: 23¼"W x 11¾"D)	204



SW2-BASEGRPHCS
Three magnetic base graphic accessories (covers 3 sides of base)

SW2-BACKSGRPHC
Magnetic reversible back accessory



PAN AND LID ACCESSORIES – PAGE 39

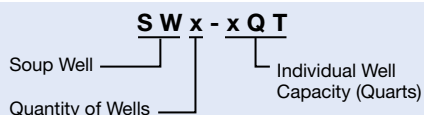



Countertop Heated Wells

Providing versatility and reliability, Hatco Countertop Heated Wells hold food hot and fresh in either a wet or dry operation with an adjustable temperature control. The -FUL units can hold a full-size pan or three third-size pans, while the -43 units can hold a full-size pan with a third-size pan or four third-size pans. The HW series are hold only, while the CHW series are capable of rethermalizing a variety of foods as well as holding (cook and hold).

- Controls feature a separate lighted On/Off rocker switch and adjustable temperature dial
- May be used dry but performs best when used with water. Dry indicator light informs user to add water
- Thicker .8 mm stainless steel pan with a stainless steel housing (aluminized steel bottom)
- Pan edge offset to help keep condensation from dripping onto countertop surface



HW-FUL with accessory food pans and pan support bar



CHW-43 with accessory food pans and pan support bar (single unit holding 1 full-size pan and 1 third-size pan)

Quick-Ship Program Information Inside Back Cover

HOLD ONLY COUNTERTOPS – FULL-SIZE AND 4/3-SIZE

Model	Dimensions W x D x H	Voltage	Watts	Plug	Approx. Ship Weight	List Price
Standard Watt						
✓ HW-FUL	14½" x 24" x 9 9/16"	120	1200	NEMA 5-15P	29 lbs.	\$ 966
✓ HW-43	14½" x 31" x 9 9/16"	120	1200	NEMA 5-15P	33 lbs.	1211

Quick-Ship Program Information Inside Back Cover

COOK & HOLD COUNTERTOPS – FULL-SIZE AND 4/3-SIZE

Model	Dimensions W x D x H	Voltage	Watts	Plug	Approx. Ship Weight	List Price
High Watt						
✓ CHW-FUL	14½" x 24" x 10 9/16"	120	1440	NEMA 5-15P	29 lbs.	\$1099
✓ CHW-43	14½" x 31" x 10 9/16"	120	1800	NEMA 5-20P	35 lbs.	1271

All Countertop Heated Well Models Feature:

Voltage: Single phase.

Cord Location: Bottom left corner on back of unit.

Models Shipped with: Stainless steel pan, stainless steel (aluminized stainless steel bottom) housing with a metal sheathed heating element, a power On/Off switch, a temperature control, a dry unit indicator light and a 6' cord with plug attached.

ACCESSORIES (available for purchase at any time)

HW-2-7QT	Adapter to convert warmer to hold two 7-Quart Inserts (models HW-FUL, CHW-FUL only)	\$145
HW-3-4QT	Adapter to convert warmer to hold three 4-Quart Inserts (models HW-FUL, CHW-FUL only)	145
HW-2-11QT	Adapter to convert warmer to hold two 11-Quart Inserts (models HW-43, CHW-43 only)	182
HW-4-4QT	Adapter to convert warmer to hold four 4-Quart Inserts (models CHW-43, HW-FUL-43 series only)	145
HW12BAR	12" Pan Support for Countertop Wells	32
HW20BAR	20" Pan Support for Countertop Wells	37

ADDITIONAL PAN AND LID ACCESSORIES – PAGES 39-40

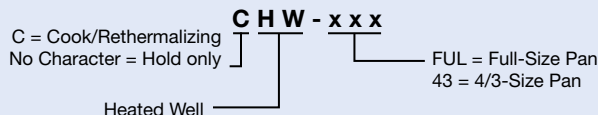

HW-4-4QT





Drop-In Induction Dry Well

Hatco's Drop-In Induction Dry Well features a simple, robust design and offers an energy efficient, plumbing-free solution to any food holding needs. This unit is adjustable with little effort and can hold either a 2½" or 4" deep pan. The well evenly and consistently heats the pan to keep foods hot and fresh.

- Durable and tough glass-ceramic well bottom can be easily adjusted to accommodate a 2½" or 4" deep pan
- Made for use with normal, full-size, ½-size, ⅓-size & ¼-size, stainless steel pans
- Contains two heat zones with two temperature sensors in each zone

- An easy-to-use, mountable control panel that can be adjusted by temperatures in Fahrenheit, Celsius or by preset temperature levels between 150° and 210°F
- Features a sensor that prohibits the unit to turn on unless a pan is present
- Includes a single stainless steel bezel
- Can be top or bottom mounted into a countertop

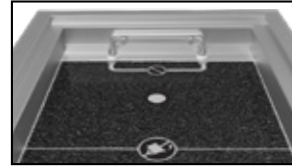

Quick-Ship Program Information Inside Back Cover

DROP-IN INDUCTION DRY WELL

Model	Dimensions W x D x H	Voltage Single Phase	Watts	Plug	Approx. Ship Weight	List Price
✓ IWELB-FUL-A	24" x 16" x 9⅓"	120	720	NEMA 5-15P	43 lbs.	\$4470
✓ IWELB-FUL-A	24" x 16" x 9⅓"	208-240	720	NEMA 6-15P	43 lbs	4470

All Drop-In Induction Dry Well Models Feature:

Models Shipped with: A 78" cable from the base to the control and a 71" cord and plug.
Cord Location: Bottom right side.

ACCESSORIES (available for purchase at any time)

Pans –

ST PAN 1/3	Third-Size Stainless Steel Pan	\$101
ST PAN 1/2	Half-Size Stainless Steel Pan	116
ST PAN 2	Full-Size Stainless Steel Pan, 2½" depth	138
ST PAN 4	Full-Size Stainless Steel Pan, 4" depth	174

Bezels –

IWELBEZEL-2	For use when ganging two units	\$317
IWELBEZEL-3	For use when ganging three units	445

Trivets –

TRIVET (1/2) SS	Half-Size – 10⅜"W x 7⅝"D	\$186
TRIVET SS	Full-Size – 10⅞"W x 18"D	259

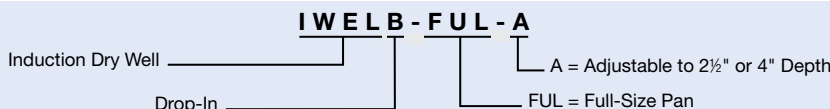
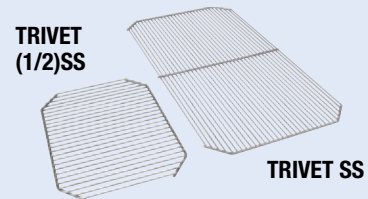
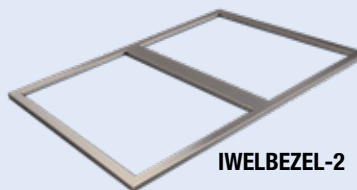
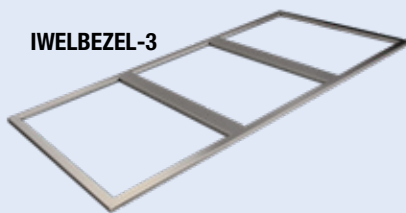



Drop-In Modular/Ganged Dry Heated Wells Ordering Instructions

Cutaway of **DHWBI-2**
with accessory food pans and
pan support bars

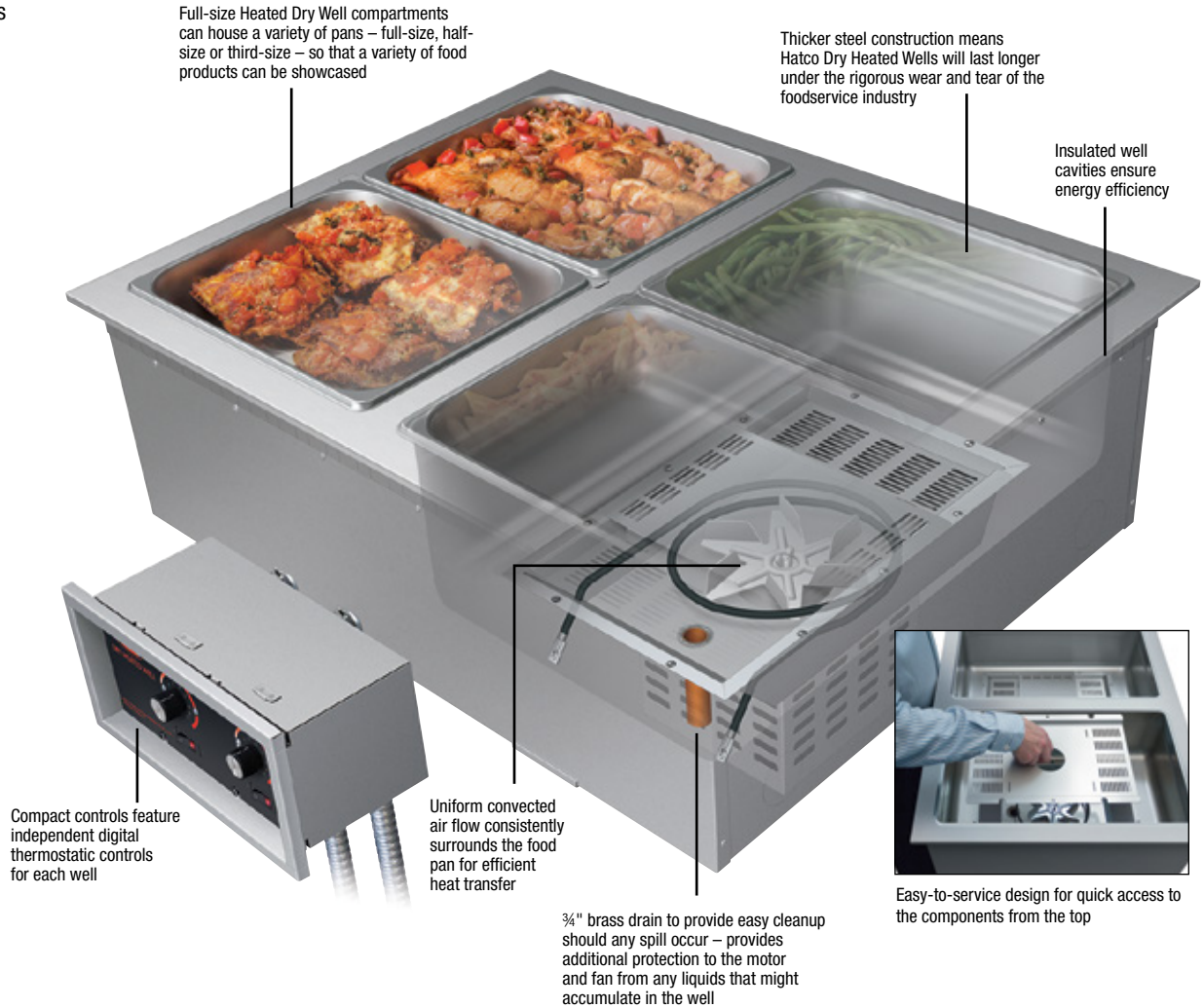

Please specify the following with each order:

1. **Desired Voltage** (single phase):
DHWBI-1, -2, -3: 120V
DHWBI-2, -3, -4, -5, -6: 120/208-240V
2. **Number of Modular/Ganged Dry Heated Wells Required:**
A. Standard Configuration: 1-, 2-, 3-, 4-, 5- or 6-pan as rectangular, full-size (12" x 20")
3. **Agency:**
A. C-UL
B. UL-EPH (sanitary listing)
4. **Control:**
A. Single Control Box (standard on all units)

Options

1. **Bezel:**
A. Standard: 23⁵/₈"
B. Oversized: 27" allows a deep bezel to match Hatco's Refrigerated Drop-In Wells in a countertop display
C. Factory installed gasket (see pg. 13)
2. **Attached cord and plug:**
DHWBI-1, -2, -3, -4

Accessories for Modular/Ganged Heated Wells

1. **Pan Support Bars:** 12" or 20"
2. **Adapters** to convert Modular/Ganged units to hold 4- or 7- quart round pans
3. **Stainless Steel Pans:**
A. Third-size (12³/₄"W x 6⁷/₈"D x 2¹/₂"H)
B. Half-size (12³/₄"W x 10³/₈"D x 2¹/₂"H)
C. Full-size at 2¹/₂" deep (12³/₄"W x 20³/₄"D x 2¹/₂"H)
D. Full-size at 4" deep (12³/₄"W x 20³/₄"D x 4"H)
E. Full-size at 6" deep (12³/₄"W x 20³/₄"D x 6"H)

ACCESSORIES – PAGES 39-40

DROP-IN MODULAR/GANGED DRY HEATED WELLS COUNTERTOP CUT-OUTS

Model	Minimum Width	Maximum Width**	Minimum Depth	Maximum Depth
DHWBI-1	14 ¹ / ₈ "	14 ³ / ₈ "	22 ¹ / ₄ "	22 ¹ / ₂ "
DHWBI-2	28 ¹ / ₈ "	28 ³ / ₈ "	22 ¹ / ₄ "	22 ¹ / ₂ "
DHWBI-3	42 ¹ / ₈ "	42 ³ / ₈ "	22 ¹ / ₄ "	22 ¹ / ₂ "
DHWBI-4	56 ¹ / ₈ "	56 ³ / ₈ "	22 ¹ / ₄ "	22 ¹ / ₂ "
DHWBI-5	70 ¹ / ₈ "	70 ³ / ₈ "	22 ¹ / ₄ "	22 ¹ / ₂ "
DHWBI-6	84 ¹ / ₈ "	84 ³ / ₈ "	22 ¹ / ₄ "	22 ¹ / ₂ "

↔ Add 1/8" to Maximum Width when using EZ locking mount.

* DHWBI-4, -5 & -6 in 120V are only available in Split Control configurations and are only available in the US, not available for Canada.



Drop-In Modular/ Ganged Dry Heated Wells

The Hatco Modular/Ganged Dry Heated Wells are full-size units that are grouped together in a modular fashion to provide customers with a complete heated food offering within one piece of equipment for a clean integrated look. Unlike traditional steam tables, this unit provides dry convected heat and is specifically designed to obtain the most accurate and consistent holding temperatures. Also offers increased design flexibility and reduced installation costs due to the lack of plumbing restrictions.

- Full-size, insulated dry wells available in 1- to 6-ganged units
- Features compact individual thermostatic controls for each well and a separate On/Off switch to retain settings
- Uniform convected air flow consistently surrounds the food pan for efficient heat transfer



DHWBI-2
with accessory (note)
food pans and additional
pan support bars

- Easy-to-service design for quick replacement or service of elements
- 3/4" NPT (National Pipe Thread) brass drain provides easy cleanup should any food spills occur, and provides additional protection to the motor and fan from any liquids that might accumulate in the well
- 6' conduit is standard for convenient placement of controls

DHWBI-1



DROP-IN MODULAR/GANGED DRY HEATED WELLS

Model	Dimensions (W x D x H)	Single Control Voltage	Watts	Approx. Ship Weight	List Price
DHWBI-1	15½" x 23⅝" x 12⅞"	120V	960	40 lbs.	\$ 4607
DHWBI-2	29½" x 23⅝" x 12⅞"	120, 120/208-240	1920	98 lbs.	7709
DHWBI-3	43½" x 23⅝" x 12⅞"	120, 120/208-240	2880	121 lbs.	10811
DHWBI-4	57½" x 23⅝" x 12⅞"	120/208-240	3840	164 lbs.	13913
DHWBI-5	71½" x 23⅝" x 12⅞"	120/208-240	4800	196 lbs.	17015
DHWBI-6	85½" x 23⅝" x 12⅞"	120/208-240	5760	233 lbs.	20117

All Drop-In Modular/Ganged Dry Heated Well Models Feature:
Models Shipped with: EZ locking hardware for installation, electronic temperature control, baffle and stainless steel bezel.

Modular/Ganged Dry Heated Wells Controls

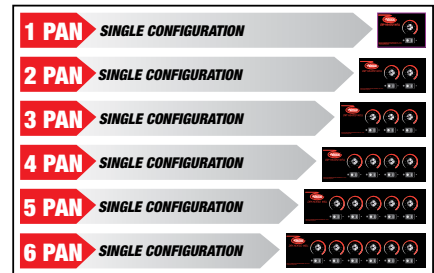

OPTIONS (available at time of purchase only)

Attached Cord and Plug for DHWBI-1, -2, -3, -4, single control and single phase only:
 DHWBI-1 (120V is NEMA-5-15P)
 DHWBI-2 (120V is NEMA-5-20P and 120/208-240V is NEMA L14-20P)
 DHWBI-3 (120V is NEMA-5-30P and 120/208-240V is NEMA L14-20P)
 DHWBI-4 (120/208-240V is NEMA L14-20P)

DHWBI-CORD		\$234
OS-BEZEL27	27" D Bezel for Modular unit to match Hatco CWB models in a countertop display	No Charge



Gasket Options –		
BEZELGASKET-1	Factory installed for DHWBI-1	\$138
BEZELGASKET-2	Factory installed for DHWBI-2	138
BEZELGASKET-3	Factory installed for DHWBI-3	180
BEZELGASKET-4	Factory installed for DHWBI-4	180
BEZELGASKET-5	Factory installed for DHWBI-5	194
BEZELGASKET-6	Factory installed for DHWBI-6	194

COUNTERTOP CUT-OUT DIMENSIONS – PAGE 17
ADDITIONAL ACCESSORIES – PAGES 39-40



Drop-In Modular/Ganged Dry Slim Heated Wells Ordering Instructions

Cutaway of **DHWBI-S4** with accessory food pans and pan support bars

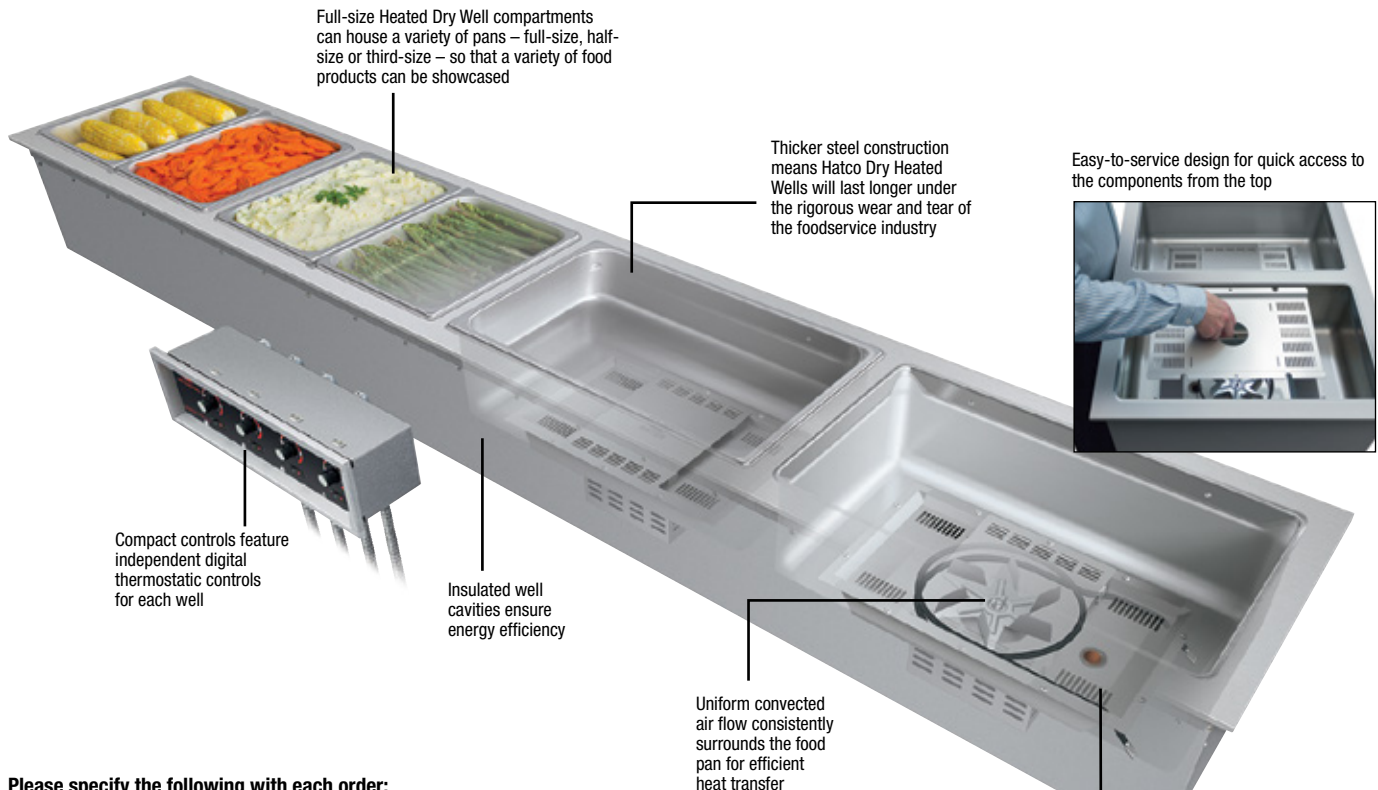

Please specify the following with each order:

- Desired Voltage** (single phase):
DHWBI-S2, -S3: 120V
DHWBI-S2, -S3, -S4: 120/208-240V
- Number of Modular/Ganged Dry Heated Wells Required:** 2-, 3- or 4-pan
Modular/Ganged Slim units are only offered as rectangular, full-size (12" x 20") but placed lengthwise
- Agency:**
A. C-UL
B. UL-EPH (sanitary listing)
- Control** – Single Control Box

Options

- Bezel:**
A. Standard: 15⁵/₁₆"
B. Oversized: 19" allows a deep bezel to match Hatco's Refrigerated Slim Drop-In Wells in a counterop display
C. Factory installed gasket (see pg. 15)
- Attached cord and plug:**
DHWBI-S2, -S3, -S4

Accessories for Modular/Ganged Heated Wells

- Pan Support Bars:** 12" or 20"
- Adapters** to convert Modular/Ganged units to hold 4- or 7- quart round pans
- Stainless Steel Pans:**
A. Third-size (12³/₄"W x 6⁷/₈"D x 2¹/₂"H)
B. Half-size (12³/₄"W x 10³/₈"D x 2¹/₂"H)
C. Full-size at 2¹/₂" deep (12³/₄"W x 20³/₄"D x 2¹/₂"H)
D. Full-size at 4" deep (12³/₄"W x 20³/₄"D x 4"H)
E. Full-size at 6" deep (12³/₄"W x 20³/₄"D x 6"H)

ACCESSORIES – PAGES 39-40

DROP-IN MODULAR/GANGED DRY SLIM HEATED WELLS COUNTERTOP CUT-OUTS

Model	Minimum Width	Maximum Width**	Minimum Depth	Maximum Depth
DHWBI-S2	43 ¹⁵ / ₁₆ "	44 ³ / ₁₆ "	14 ¹ / ₃₂ "	14 ⁹ / ₃₂ "
DHWBI-S3	65 ¹⁵ / ₁₆ "	66 ³ / ₁₆ "	14 ¹ / ₃₂ "	14 ⁹ / ₃₂ "
DHWBI-S4	87 ¹⁵ / ₁₆ "	88 ³ / ₁₆ "	14 ¹ / ₃₂ "	14 ⁹ / ₃₂ "

** Add 1/16" to Maximum Width when using EZ locking mount.

* DHWBI-S4 in 120V is only available in Split Control configurations and are only available in the US, not available for Canada.



Drop-In Modular/Ganged Dry Slim Heated Wells

The Hatco Modular/Ganged Dry Slim Heated Wells are full-size units that are grouped together in a modular fashion but placed lengthwise. This provides customers with a complete heated food offering within easy reach. Unlike traditional steam tables, this unit provides dry convected heat and is specifically designed to obtain the most accurate and consistent holding temperatures. Also offers increased design flexibility and reduced installation costs due to the lack of plumbing restrictions.

- Full-size, insulated dry wells available in 2- to 4-ganged units
- Features compact individual thermostatic controls for each well and a separate On/Off switch to retain settings
- Uniform convected air flow consistently surrounds the food pan for efficient heat transfer
- Easy-to-service design for quick replacement or service of elements
- 3/4" NPT (National Pipe Thread) brass drain provides easy cleanup should any food spills occur, and provides additional protection to the motor and fan from any liquids that might accumulate in the well
- 6' conduit is standard for convenient placement of controls

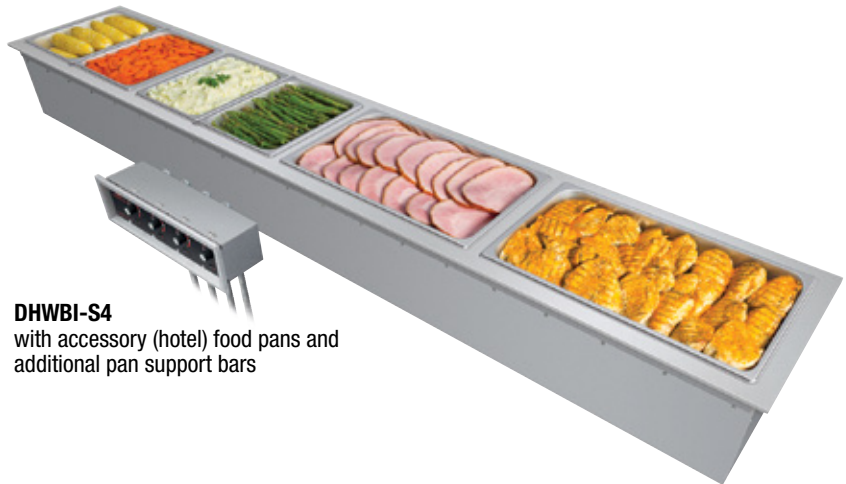

DHWBI-S4 with accessory (hotel) food pans and additional pan support bars

DROP-IN MODULAR/GANGED DRY SLIM HEATED WELLS

Model	Dimensions (W x D x H)	Single Control Voltage	Wattage	Approx. Ship Weight	List Price
DHWBI-S2	45 1/2" x 15 5/8" x 12 1/16"	120V, 120/208-240	1920	94 lbs.	\$ 8238
DHWBI-S3	67 1/2" x 15 5/8" x 12 1/16"	120V, 120/208-240	2880	146 lbs.	11500
DHWBI-S4	89 1/2" x 15 5/8" x 12 1/16"	120/208-240	3840	177 lbs.	14762

All Drop-In Modular/Ganged Dry Slim Heated Well Models Feature: Models Shipped with: EZ locking hardware for installation, electronic temperature control, baffles and stainless steel bezel.

OPTIONS (available at time of purchase only)

Attached Cord and Plug for single control and single phase only: DHWBI-S2 (120V is NEMA-5-20P and 120/208-240V is NEMA L14-20P) DHWBI-S3 (120V is NEMA-5-30P and 120/208-240V is NEMA L14-20P) DHWBI-S4 (120/208-240V is NEMA L14-20P)

DHWBI-CORD		\$234
OS-BEZEL19	19" D Bezel for Modular unit to match Hatco CWB Slim models in a countertop display	No Charge



Gasket Options –	
BEZELGASKET-S2	\$138
BEZELGASKET-S3	180
BEZELGASKET-S4	180

Modular/Ganged Dry Heated Wells Controls

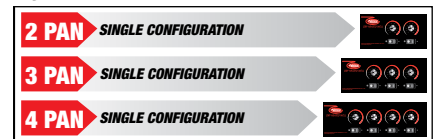

* Split Control configurations are not available in Canada

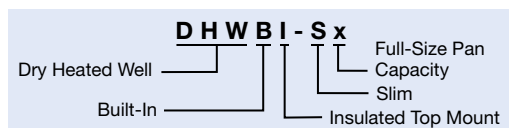

COUNTERTOP CUT-OUT DIMENSIONS – PAGE 19
ADDITIONAL ACCESSORIES – PAGES 39-40



Modular/Ganged Heated Wells (Full and 4/3-Size) Ordering Instructions

Cutaway of HWBI-5MA with accessory food pans

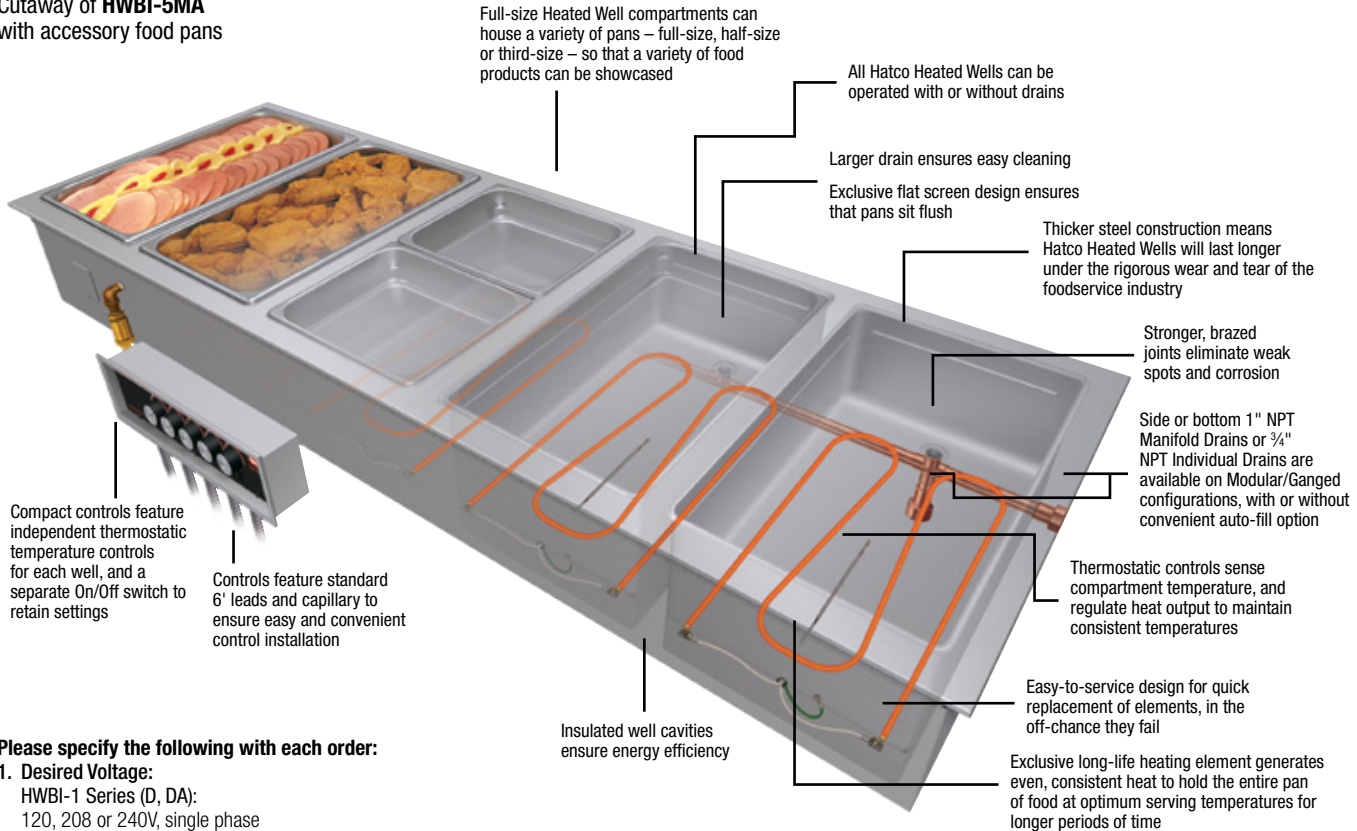

Please specify the following with each order:

- Desired Voltage:**
 HWBI-1 Series (D, DA): 120, 208 or 240V, single phase
 HWBI-2, -3, -4, -5, -6 Series (D, DA, M, MA): 208 or 240V, single or optional three phase
 HWBLI-1, -2, -3, -4, -5, -6 Series (D, DA, M, MA): 120V, single phase
 HWBI43-1(D, DA): 120, 208 or 240V, single phase
 HWBI43-2, -3, -6 Series (D, DA, M, MA): 208 or 240V, single or optional three phase
 HWBI43-4, -5 Series (D, DA, M, MA): 240V, single or optional three phase
- Desired Wattage:**
 A. Standard Watt
 B. Low Watt (120V only, and not available for HWBI43 Series)
- Number of Modular/Ganged Heated Wells Required:**
 1-, 2-, 3-, 4-, 5- or 6-pan
NOTE: Modular/Ganged units are only offered as rectangular, full-size (12" x 20") or as 4/3-size wells (12" x 27")

- Drain (with or without – choose drain below):**
 A. Standard Individual Well 3/4" NPT Drain
 B. Manifold 1" NPT Drain with side drain, field selectable left or right side (available on HWBI- or HWBLI-2, -3, -4, -5, -6 models only)
 C. Manifold 1" NPT Drain with bottom drain, field selectable left or right well (available on HWBI- or HWBLI-2, -3, -4, -5, -6 models only)
- Auto-fill (with or without)**
- Bezel** allows an optional 27" depth for modular units to match Hatco CWB models in a countertop display (not available for HWBI43 Series)
- Agency:**
 A. C-UL
 B. UL-EPH (sanitary listing)
- Control:**
 Single Control Box

Accessories for Modular/Ganged Heated Wells

- Pan Support Bars:**
 A. Standard or Slim configuration 12" or 20"
 B. 4/3-size configuration 12"
- Adapters** to convert Modular/Ganged units to hold 4- or 7-quart round pans
- Stainless Steel Pans:**
 A. Third-size (12 3/4"W x 6 7/8"D x 2 1/2"H)
 B. Half-size (12 3/4"W x 10 3/8"D x 2 1/2"H)
 C. Full-size at 2 1/2" deep (12 3/4"W x 20 3/4"D x 2 1/2"H)
 D. Full-size at 4" deep (12 3/4"W x 20 3/4"D x 4"H)
 E. Full-size at 6" deep (12 3/4"W x 20 3/4"D x 6"H)
- Valves:**
 A. 3/4" or 1" NPT Ball Valve
 B. 3/4" or 1" NPT Gate Valve
- Heated Well Covers** to convert Modular/Ganged units to heated shelves (not available for HWBI43 Series):
 A. 1-Pan Heated Well Cover
 B. 2-Pan Heated Well Cover

DROP-IN MODULAR/GANGED HEATED WELLS COUNTERTOP CUT-OUTS

Model	Minimum Width	Maximum Width	Minimum Depth	Maximum Depth
HWBI-, HWBLI-1 Series	14 1/8"	14 1/2"	22 1/4"	22 5/8"
HWBI-, HWBLI-2 Series	28 3/8"	28 1/2"	22 1/4"	22 5/8"
HWBI-, HWBLI-3 Series	42 3/8"	42 1/2"	22 1/4"	22 5/8"
HWBI-, HWBLI-4 Series	56 3/8"	56 1/2"	22 1/4"	22 5/8"
HWBI-, HWBLI-5 Series	70 3/8"	70 1/2"	22 1/4"	22 5/8"
HWBI-, HWBLI-6 Series	84 3/8"	84 1/2"	22 1/4"	22 5/8"
4/3-Size				
HWBI43-1 Series	14 3/16"	14 3/8"	29 1/8"	29 3/8"
HWBI43-2 Series	28 3/16"	28 3/8"	29 1/8"	29 3/8"
HWBI43-3 Series	42 3/16"	42 3/8"	29 1/8"	29 3/8"
HWBI43-4 Series	56 3/16"	56 3/8"	29 1/8"	29 3/8"
HWBI43-5 Series	70 3/16"	70 3/8"	29 1/8"	29 3/8"
HWBI43-6 Series	84 3/16"	84 3/8"	29 1/8"	29 3/8"

ACCESSORIES – PAGES 27, 39-40

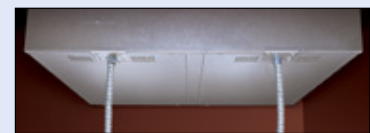

From the top, the modular design allows the Modular/Ganged Heated Well to appear as one integrated unit. From below, you will see separate covers, with easy, independent access to each one. This makes installation and service easy



Drop-In Modular/Ganged Heated Wells

Hatco Modular/Ganged Heated Wells are full-size units that are grouped together in a modular fashion to provide customers with a complete steam table contained within one piece of equipment for a clean, integrated look.

- Full-size, insulated wells available in 1- to 6-ganged units in either standard or low wattages
- Individual thermostatic controls for each well provide the ultimate in temperature regulation
- 6' conduit is standard for convenient placement of controls

- Wells empty quickly and easily with a manifold drain option
- Auto-fill option to automatically fill and replenish water without user maintenance and intervention
- Separate well assemblies with independent access to each one for easy service

HWBLI-5MA with accessory food pans and standard single control box



LOW WATT DROP-IN MODULAR/GANGED FULL-SIZE RECTANGULAR WELLS – INSULATED – TOP MOUNT – LOW WATT

Model	Dimensions (W x D x H)	Watts	Approx. Ship Weight	List Price
HWBLI-1	15½" x 23⅝" x 9⅞"	750	38 lbs.	\$ 2263
HWBLI-1D	15½" x 23⅝" x 9⅞"	750	36 lbs.	2435
HWBLI-1DA	15½" x 23⅝" x 9⅞"	750	38 lbs.	3442
HWBLI-2	29½" x 23⅝" x 9⅞"	1500	82 lbs.	4784
HWBLI-2D	29½" x 23⅝" x 9⅞"	1500	85 lbs.	5032
HWBLI-2DA	29½" x 23⅝" x 9⅞"	1500	87 lbs.	6012
HWBLI-2M	29½" x 23⅝" x 9⅞"	1500	84 lbs.	5146
HWBLI-2MA	29½" x 23⅝" x 9⅞"	1500	85 lbs.	6455
HWBLI-3	43½" x 23⅝" x 9⅞"	2250	106 lbs.	5968
HWBLI-3D	43½" x 23⅝" x 9⅞"	2250	110 lbs.	6415
HWBLI-3DA	43½" x 23⅝" x 9⅞"	2250	114 lbs.	6898
HWBLI-3M	43½" x 23⅝" x 9⅞"	2250	105 lbs.	6821
HWBLI-3MA	43½" x 23⅝" x 9⅞"	2250	124 lbs.	8129
HWBLI-4	57½" x 23⅝" x 9⅞"	3000	134 lbs.	7741
HWBLI-4D	57½" x 23⅝" x 9⅞"	3000	155 lbs.	8545
HWBLI-4DA	57½" x 23⅝" x 9⅞"	3000	133 lbs.	9525
HWBLI-4M	57½" x 23⅝" x 9⅞"	3000	148 lbs.	9223
HWBLI-4MA	57½" x 23⅝" x 9⅞"	3000	141 lbs.	10533
HWBLI-5	71½" x 23⅝" x 9⅞"	3750	167 lbs.	9281
HWBLI-5D	71½" x 23⅝" x 9⅞"	3750	166 lbs.	10638
HWBLI-5DA	71½" x 23⅝" x 9⅞"	3750	167 lbs.	11643
HWBLI-5M	71½" x 23⅝" x 9⅞"	3750	188 lbs.	11528
HWBLI-5MA	71½" x 23⅝" x 9⅞"	3750	193 lbs.	12804
HWBLI-6	85½" x 23⅝" x 9⅞"	4500	194 lbs.	12023
HWBLI-6D	85½" x 23⅝" x 9⅞"	4500	203 lbs.	13102
HWBLI-6DA	85½" x 23⅝" x 9⅞"	4500	200 lbs.	14039
HWBLI-6M	85½" x 23⅝" x 9⅞"	4500	200 lbs.	14320
HWBLI-6MA	85½" x 23⅝" x 9⅞"	4500	200 lbs.	15563

Ⓢ Auto-fill located on left control only and fills left-hand well. To fill all wells, drains must be connected with external manifold by installer.

All Low Watt Drop-In Modular/Ganged Full-Size Rectangular Heated Well Models Feature:

Voltage: HWBLI-1DA, 2, -3, -4, -5, -6 Series: 120V, single phase.
 Models Shipped with: EZ locking hardware for installation and remote thermostats with flexible conduits and lighted power switches.

OPTIONS (available at time of purchase only)

HWBI-SIDE	Copper Manifold Drain with side exit (not available on HWBLI-1)	No Charge
HWBI-BOTTOM	Copper Manifold Drain with bottom exit (not available on HWBLI-1)	No Charge
HWBLI-CORD-2	Cord for HWBLI-2 (single phase)	\$165
HWBLI-CORD-3	Cord for HWBLI-3 (single phase)	303
OS-BEZEL27	27" deep Bezel for Modular unit to match Hatco CWB in a countertop display	No Charge

Gasket Options –

BEZELGASKET-1	Factory installed for HWBLI-1	\$138
BEZELGASKET-2	Factory installed for HWBLI-2	138
BEZELGASKET-3	Factory installed for HWBLI-3	180
BEZELGASKET-4	Factory installed for HWBLI-4	180
BEZELGASKET-5	Factory installed for HWBLI-5	194
BEZELGASKET-6	Factory installed for HWBLI-6	194

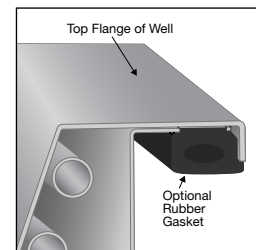

BEZELGASKET-1
 Factory installed option (eliminates the need for silicone or other sealants)

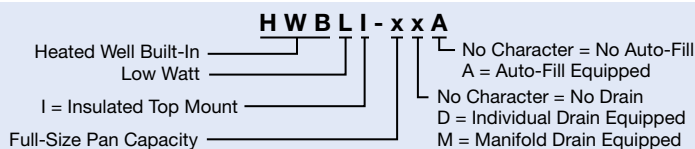

COUNTERTOP CUT-OUT DIMENSIONS – PAGE 21
ACCESSORIES – PAGES 27, 39-40



Drop-In Modular/ Ganged Heated Wells - Continued

STANDARD WATT DROP-IN MODULAR/GANGED FULL-SIZE RECTANGULAR WELLS – INSULATED – TOP MOUNT

Model	Dimensions W x D x H	Watts	Approx. Ship Weight	List Price
HWBI-1	15½" x 23¾" x 9⅞"	1215	34 lbs.	\$ 2263
HWBI-1D	15½" x 23¾" x 9⅞"	1215	38 lbs.	2435
HWBI-1DA	15½" x 23¾" x 9⅞"	1215	38 lbs.	3442
HWBI-2	29½" x 23¾" x 9⅞"	2415	73 lbs.	4784
HWBI-2D [ⓐ]	29½" x 23¾" x 9⅞"	2415	77 lbs.	5032
HWBI-2DA	29½" x 23¾" x 9⅞"	2415	87 lbs.	6012
HWBI-2M	29½" x 23¾" x 9⅞"	2415	74 lbs.	5146
HWBI-2MA	29½" x 23¾" x 9⅞"	2415	85 lbs.	6455
HWBI-3	43½" x 23¾" x 9⅞"	3615	103 lbs.	5968
HWBI-3D	43½" x 23¾" x 9⅞"	3615	114 lbs.	6415
HWBI-3DA [ⓐ]	43½" x 23¾" x 9⅞"	3615	114 lbs.	6898
HWBI-3M	43½" x 23¾" x 9⅞"	3615	108 lbs.	6821
HWBI-3MA	43½" x 23¾" x 9⅞"	3615	112 lbs.	8129
HWBI-4	57½" x 23¾" x 9⅞"	4815	132 lbs.	7741
HWBI-4D	57½" x 23¾" x 9⅞"	4815	136 lbs.	8545
HWBI-4DA [ⓐ]	57½" x 23¾" x 9⅞"	4815	133 lbs.	9525
HWBI-4M	57½" x 23¾" x 9⅞"	4815	138 lbs.	9223
HWBI-4MA	57½" x 23¾" x 9⅞"	4815	138 lbs.	10533
HWBI-5	71½" x 23¾" x 9⅞"	6015	167 lbs.	9281
HWBI-5D	71½" x 23¾" x 9⅞"	6015	167 lbs.	10638
HWBI-5DA [ⓐ]	71½" x 23¾" x 9⅞"	6015	167 lbs.	11643
HWBI-5M	71½" x 23¾" x 9⅞"	6015	167 lbs.	11528
HWBI-5MA	71½" x 23¾" x 9⅞"	6015	184 lbs.	12804
HWBI-6	85½" x 23¾" x 9⅞"	7215	189 lbs.	12023
HWBI-6D	85½" x 23¾" x 9⅞"	7215	189 lbs.	13102
HWBI-6DA [ⓐ]	85½" x 23¾" x 9⅞"	7215	193 lbs.	14039
HWBI-6M	85½" x 23¾" x 9⅞"	7215	189 lbs.	14320
HWBI-6MA	85½" x 23¾" x 9⅞"	7215	195 lbs.	15563

[ⓐ] Auto-fill located on left control only and fills left-hand well. To fill all wells, drains must be connected with external manifold by installer.

All Standard Watt Drop-In Modular/Ganged Full-Size Rectangular Heated Well Models Feature:

Voltage: HWBI-1 Series: 120, 208 or 240V, single phase.

HWBI-2, -3, -4, -5, -6 Series: 208 or 240V, single phase or optional three phase.

Models Shipped with: EZ locking hardware for installation and remote thermostats with 6' flexible conduits and lighted power switches.



HWBI-3MA with
accessory food pans and
optional cord for HWBI-3

Heated & Cold Wells

Modular/Ganged Heated Wells Controls

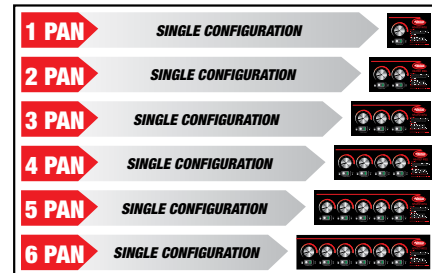

DROP-IN MODULAR/GANGED AMP RATINGS

Model	208V/1 Ø	240V/1 Ø	208V/3 Ø	240V/3 Ø
HWBI-2	11.6	10.1	10.1	8.7
HWBI-3	17.4	15.1	10.1	8.8
HWBI-4	23.2	20.1	15.8	13.7
HWBI-5	28.9	25.1	20.1	17.4
HWBI-6	34.7	30.1	20.1	17.4

OPTIONS (available at time of purchase only)

HWBI-3PH	Three-Phase Wiring (not available on HWBI-1 series)	No Charge
HWBI-SIDE	Copper Manifold Drain with side exit (not available on HWBI-1)	No Charge
HWBI-BOTTOM	Copper Manifold Drain with bottom exit (not available on HWBI-1)	No Charge
HWBI-CORD-1, -2	Cord for HWBI-1, -2 (single phase)	\$165
HWBI-CORD-3, -4	Cord for HWBI-3, -4 (single phase)	303
HWBI-CORD-5, -6	Cord for HWBI-5, -6 (single phase)	584
OS-BEZEL27	27" deep Bezel for Modular unit to match Hatco CWB in a countertop display	No Charge

Gasket Options –

BEZELGASKET-1	Factory installed for HWBI-1	\$138
BEZELGASKET-2	Factory installed for HWBI-2	138
BEZELGASKET-3	Factory installed for HWBI-3	180
BEZELGASKET-4	Factory installed for HWBI-4	180
BEZELGASKET-5	Factory installed for HWBI-5	194
BEZELGASKET-6	Factory installed for HWBI-6	194

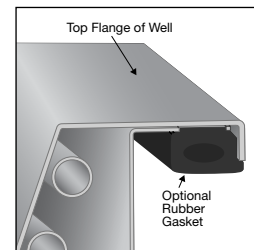

BEZELGASKET-1

Factory installed option (eliminates the need for silicone or other sealants)

HWBI - x x A

Heated Well Built-In	_____	No Character = No Auto-Fill
I = Insulated Top Mount	_____	A = Auto-Fill Equipped
Full-Size Pan Capacity	_____	No Character = No Drain
		D = Individual Drain Equipped
		M = Manifold Drain Equipped

COUNTERTOP CUT-OUT DIMENSIONS – PAGE 21
ACCESSORIES – PAGES 27, 39-40



Drop-In Modular/Ganged 4/3-Size Heated Wells

Hatco Modular/Ganged 4/3-Size Heated Wells maintain hot food at safe-serving temperatures, with better quality construction, longer holding times and more accurate temperatures. A deeper single unit can hold the equivalent of 4 third-size pans.

Choose the number of wells, from 1 to 6 unit configurations, as well as voltage, auto-fill, controls and drain options. Each well has its own individual control to regulate the temperature of each food offering.

- Longer holding times with more accurate temperatures
- Separate lighted On/Off rocker switch and temperature dial for easy operation

- 50% larger drain with flat screen simplifies cleaning and holds pans level
- Unique design allows quick change of element or thermostat if needed
- EZ locking hardware for quick installation
- Stainless steel construction and solid brazed drain fitting joints for durability
- A 6' (1829 mm) conduit is included for convenient placement of controls

DROP-IN MODULAR/GANGED 4/3-SIZE RECTANGULAR WELLS – INSULATED – TOP MOUNT

Model	Dimensions W x D x H	Voltage	Watts	Approx. Ship Weight	List Price
HWBI43-1	15½" x 30¾" x 9¾"	208 or 240	1215	42 lbs.	\$ 3190
HWBI43-1D	15½" x 30¾" x 9¾"	208 or 240	1215	42 lbs.	3284
HWBI43-1DA	15½" x 30¾" x 9¾"	208 or 240	1215	47 lbs.	4463
HWBI43-2	29½" x 30¾" x 9¾"	208 or 240	2415	88 lbs.	5320
HWBI43-2D	29½" x 30¾" x 9¾"	208 or 240	2415	96 lbs.	5517
HWBI43-2DA*	29½" x 30¾" x 9¾"	208 or 240	2415	95 lbs.	6740
HWBI43-2M	29½" x 30¾" x 9¾"	208 or 240	2415	82 lbs.	6050
HWBI43-2MA	29½" x 30¾" x 9¾"	208 or 240	2415	98 lbs.	7275
HWBI43-3	43½" x 30¾" x 9¾"	208 or 240	3615	115 lbs.	7264
HWBI43-3D	43½" x 30¾" x 9¾"	208 or 240	3615	112 lbs.	7552
HWBI43-3DA*	43½" x 30¾" x 9¾"	208 or 240	3615	124 lbs.	8741
HWBI43-3M	43½" x 30¾" x 9¾"	208 or 240	3615	135 lbs.	8164
HWBI43-3MA	43½" x 30¾" x 9¾"	208 or 240	3615	135 lbs.	9357
HWBI43-4	57½" x 30¾" x 9¾"	208 or 240	4815	166 lbs.	9570
HWBI43-4D	57½" x 30¾" x 9¾"	208 or 240	4815	152 lbs.	9955
HWBI43-4DA*	57½" x 30¾" x 9¾"	208 or 240	4815	149 lbs.	11146
HWBI43-4M	57½" x 30¾" x 9¾"	208 or 240	4815	154 lbs.	10645
HWBI43-4MA	57½" x 30¾" x 9¾"	208 or 240	4815	180 lbs.	11837
HWBI43-5	71½" x 30¾" x 9¾"	208 or 240	6015	197 lbs.	11660
HWBI43-5D	71½" x 30¾" x 9¾"	208 or 240	6015	186 lbs.	12158
HWBI43-5DA*	71½" x 30¾" x 9¾"	208 or 240	6015	187 lbs.	13386
HWBI43-5M	71½" x 30¾" x 9¾"	208 or 240	6015	186 lbs.	12946
HWBI43-5MA	71½" x 30¾" x 9¾"	208 or 240	6015	203 lbs.	14174
HWBI43-6	85½" x 30¾" x 9¾"	208 or 240	7215	214 lbs.	13924
HWBI43-6D	85½" x 30¾" x 9¾"	208 or 240	7215	214 lbs.	14556
HWBI43-6DA*	85½" x 30¾" x 9¾"	208 or 240	7215	217 lbs.	15837
HWBI43-6M	85½" x 30¾" x 9¾"	208 or 240	7215	214 lbs.	15577
HWBI43-6MA	85½" x 30¾" x 9¾"	208 or 240	7215	249 lbs.	16847

* Auto-fill located on left control only and fills left-hand well. To fill all wells, drains must be connected with external manifold by installer.

All Drop-In Modular/Ganged 4/3-Size Rectangular Heated Well Models Feature:

Phase: HWBI43-1 Series: Single only.

HWBI43-2, -3, -4, -5, -6 Series: Single or optional three phase.

Models Shipped with: EZ locking hardware for installation and remote thermostats with flexible conduits and lighted power switches.



HWBI43-3DA with
- 4 third-size pans,
- 2 half-size pans and 1 third-size pan
- 1 full-size pan and 1 third-size pan

Modular/Ganged Heated Wells Controls

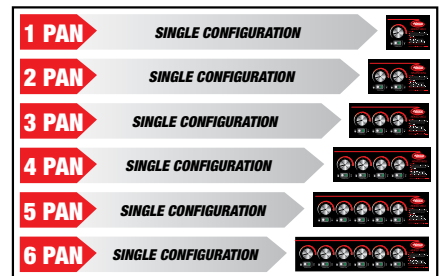

COUNTERTOP CUT-OUT DIMENSIONS – PAGE 21 ACCESSORIES – PAGES 27, 39-40

OPTIONS (available at time of purchase only)

HWBI-3PH	Three-Phase Wiring (not available on HWBI43-1 series)	No Charge
HWBI-SIDE	Copper Manifold Drain with side exit (not available on HWBI43-1)	No Charge
HWBI-BOTTOM	Copper Manifold Drain with bottom exit (not available on HWBI43-1)	No Charge
HWBI-CORD-1, -2	Cord for HWBI43-1, -2 (single phase)	\$165
HWBI-CORD-3, -4	Cord for HWBI43-3, -4 (single phase)	303
HWBI-CORD-5, -6	Cord for HWBI43-5, -6 (single phase)	584

Gasket Options –

BEZELGASKET-1	Factory installed for HWBI43-1	\$138
BEZELGASKET-2	Factory installed for HWBI43-2	138
BEZELGASKET-3	Factory installed for HWBI43-3	180
BEZELGASKET-4	Factory installed for HWBI43-4	180
BEZELGASKET-5	Factory installed for HWBI43-5	194
BEZELGASKET-6	Factory installed for HWBI43-6	194

DROP-IN MODULAR/GANGED 4/3-SIZE 3 Ø AMP RATINGS

Model	208V/3 Ø Amps	240V/3 Ø Amps
HWBI43-2	10.1	8.7
HWBI43-3	10.1	8.8
HWBI43-4	15.8	13.7
HWBI43-5	20.1	17.4
HWBI43-6	20.1	17.4

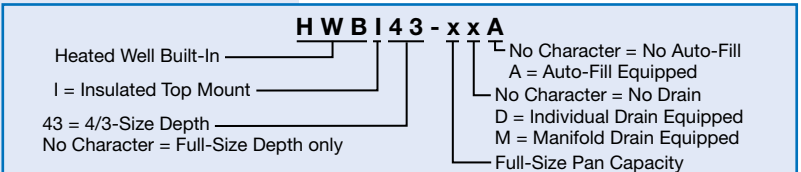



Drop-In Modular/Ganged Slim Heated Wells Ordering Instructions

Cutaway of **HWBI-S4MA**
with accessory food pans

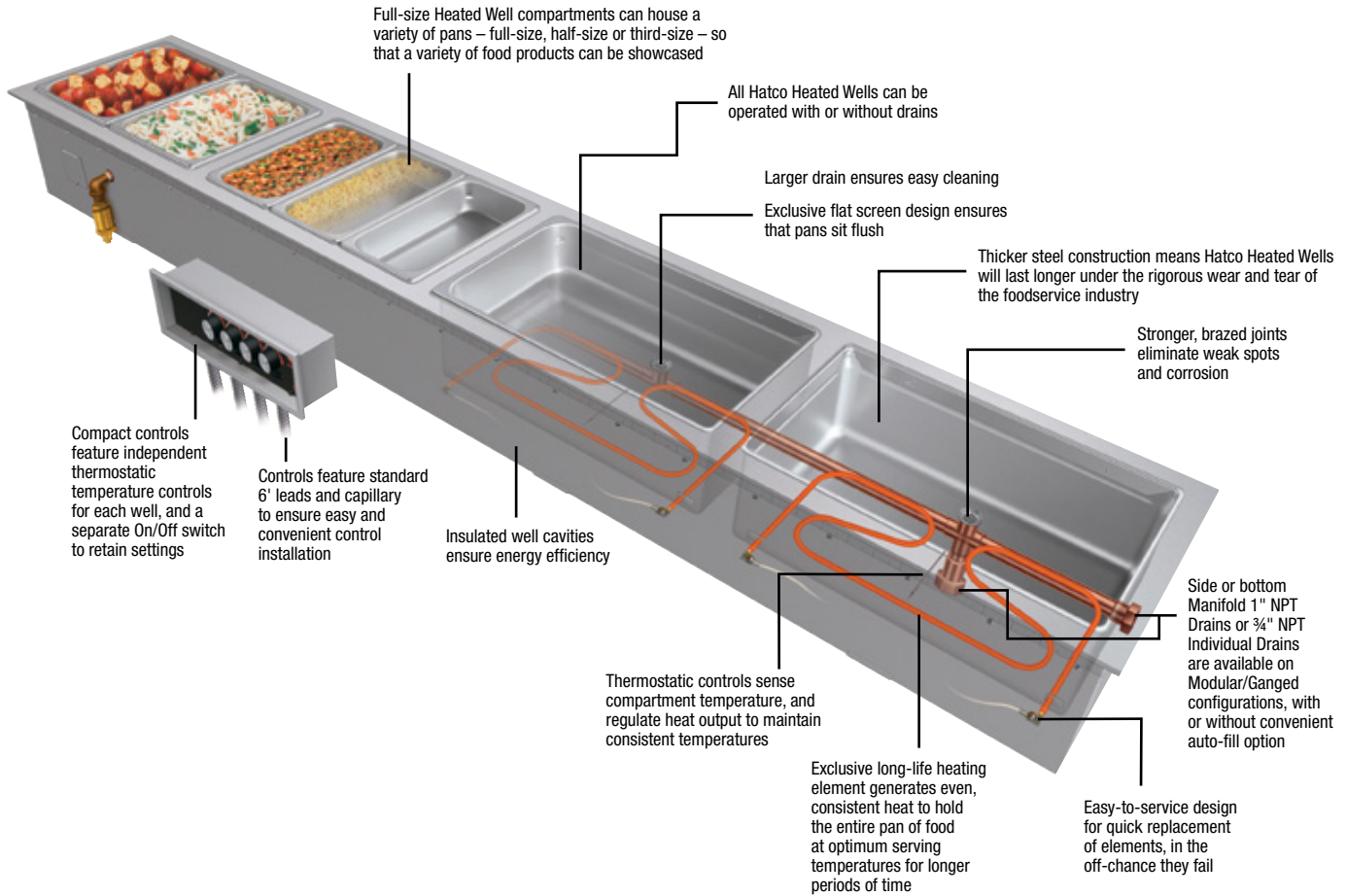

Please specify the following with each order:

1. **Desired Voltage:** 208 or 240V
 - A. Single phase (standard)
 - B. Three phase (optional)
2. **Number of Modular/Ganged Slim Heated Wells Required:** 2-, 3-, 4-pan

NOTE: Modular/Ganged Slim units are only offered as rectangular, full-size (12" x 20") but placed lengthwise
3. **Drain** (with or without – choose drain below):
 - A. Standard Individual Well 3/4" NPT Drain
 - B. Manifold 1" NPT Drain with side drain, field selectable left or right side
 - C. Manifold 1" NPT Drain with bottom drain, field selectable left or right well

4. **Auto-fill** (with or without)
5. **Bezel** allows an optional 19" D for modular units to match Hatco Refrigerated Slim Drop-In models in a countertop display
6. **Agency:**
 - A. C-UL
 - B. UL-EPH (sanitary listing)
7. **Control** – Single Control Box

Accessories for Modular/Ganged Slim Heated Wells

1. **Pan Support Bars:** 12" or 20"
2. **Adapters** to convert Modular/Ganged Slim units to hold 4- or 7-quart round pans
3. **Stainless Steel Pans:**
 - A. Third-size at 2 1/2" deep (12 3/4"W x 6 7/8"D x 2 1/2"H)
 - B. Half-size at 2 1/2" deep (12 3/4"W x 10 3/8"D x 2 1/2"H)
 - C. Full-size at 2 1/2" deep (12 3/4"W x 20 3/4"D x 2 1/2"H)
 - D. Full-size at 4" deep (12 3/4"W x 20 3/4"D x 4"H)
 - E. Full-size at 6" deep (12 3/4"W x 20 3/4"D x 6"H)
4. **Valves:**
 - A. 3/4" or 1" NPT Ball Valve
 - B. 3/4" or 1" NPT Gate Valve
5. **Heated Well Covers** to convert Slim Modular/Ganged units to heated shelves:
 - A. 1-Pan Heated Well Cover

DROP-IN MODULAR/GANGED SLIM HEATED WELLS COUNTERTOP CUT-OUTS

Model	Minimum Width	Maximum Width	Minimum Depth	Maximum Depth
HWBI-S2 Series	44 1/8"	44 3/8"	14 1/4"	14 1/2"
HWBI-S3 Series	66 1/8"	66 3/8"	14 1/4"	14 1/2"
HWBI-S4 Series	88 1/8"	88 3/8"	14 1/4"	14 1/2"

ACCESSORIES – PAGES 27, 39-40



Modular/Ganged Slim Heated Wells

Hatco Modular/Ganged Slim Heated Wells are full-sized units that are grouped together in a modular fashion but placed lengthwise. This provides customers with a complete steam table within easy reach. Select the configuration that's right for your foodservice operation.

- Full-size, insulated wells available in 2- to 4-modular/ganged units
- Individual thermostatic controls for each well provide the ultimate in temperature regulation
- 6' conduit is standard for convenient placement of controls

- Wells empty quickly and easily with a manifold drain option
- Auto-fill option to automatically fill and replenish water without user maintenance and intervention
- Separate well assemblies with independent access to each one for easy service



HWBI-S4MA with accessory food pans

DROP-IN MODULAR/GANGED SLIM RECTANGULAR WELLS – INSULATED – TOP MOUNT

Model	Dimensions W x D x H	Watts	Approx. Ship Weight	List Price
HWBI-S2	45½" x 15½" x 9⅞"	2415	83 lbs.	\$ 5178
HWBI-S2D	45½" x 15½" x 9⅞"	2415	81 lbs.	5412
HWBI-S2DA [Ⓢ]	45½" x 15½" x 9⅞"	2415	84 lbs.	6394
HWBI-S2M	45½" x 15½" x 9⅞"	2415	86 lbs.	5607
HWBI-S2MA	45½" x 15½" x 9⅞"	2415	90 lbs.	6909
HWBI-S3	67½" x 15½" x 9⅞"	3615	118 lbs.	6537
HWBI-S3D	67½" x 15½" x 9⅞"	3615	115 lbs.	7011
HWBI-S3DA [Ⓢ]	67½" x 15½" x 9⅞"	3615	125 lbs.	7967
HWBI-S3M	67½" x 15½" x 9⅞"	3615	115 lbs.	7455
HWBI-S3MA	67½" x 15½" x 9⅞"	3615	125 lbs.	8759
HWBI-S4	89½" x 15½" x 9⅞"	4815	154 lbs.	8658
HWBI-S4D	89½" x 15½" x 9⅞"	4815	155 lbs.	9386
HWBI-S4DA [Ⓢ]	89½" x 15½" x 9⅞"	4815	160 lbs.	10340
HWBI-S4M	89½" x 15½" x 9⅞"	4815	154 lbs.	10095
HWBI-S4MA	89½" x 15½" x 9⅞"	4815	153 lbs.	11362

[Ⓢ] Auto-fill fills left-hand well. To fill all wells, drains must be connected with external manifold by installer.

All Drop-In Modular Slim Rectangular Heated Well Models Feature:

Voltage: HWBI-S2, -S3, -S4 Series: 208 or 240V, single phase or optional three phase.

Models Shipped with: EZ locking hardware for installation and remote thermostats with lighted power switches.

OPTIONS (available at time of purchase only)

HWBI-3PH	Three-Phase Wiring (field convertible)	No Charge
HWBI-SIDE	Copper Manifold Drain with side exit	No Charge
HWBI-BOTTOM	Copper Manifold Drain with bottom exit	No Charge
HWBI-CORD-S2	Cord for HWBI-S2 (single phase)	\$165
HWBI-CORD-S3, -S4	Cord for HWBI-S3, -S4 (single phase)	165
	19" D Bezel for Modular unit to match	
OS-BEZEL19	Hatco CWB Slim models in a countertop display	No Charge
Gasket Options –		
BEZELGASKET-S2		\$138
BEZELGASKET-S3		180
BEZELGASKET-S4		180

COUNTERTOP CUT-OUT DIMENSIONS – PAGE 25 ACCESSORIES – PAGES 27, 39-40

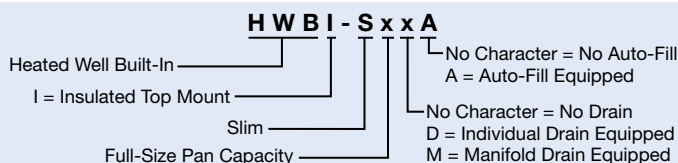

Modular/Ganged Slim Heated Wells Controls

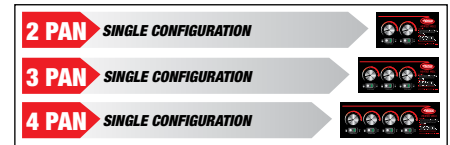

* 4-pan units: Single control box is standard. If optional split control boxes are desired, it must be specified at order (for Canada, split control boxes not available).

DROP-IN SLIM MODULAR/GANGED AMP RATINGS

Model	208V/ 1 Ø	240V/ 1 Ø	208V/ 3 Ø	240V/ 3 Ø
HWBI-S2	11.6	10.1	10.1	8.7
HWBI-S3	17.4	15.1	10.1	8.8
HWBI-S4	23.2	20.1	15.8	13.7

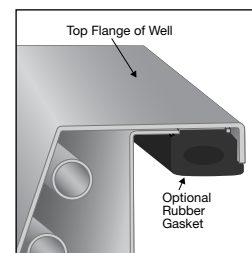

BEZELGASKET-S2
Factory installed option (eliminates the need for silicone or other sealants)



Drop-In Modular/Ganged Heated Wells Accessories

(available for purchase at any time)

HEATED WELL COVERS (available for purchase at any time)

For Modular/Ganged Heated Wells and Modular/Ganged Slim Heated Wells. (Choose the number of heated well covers for your appropriate pan size in either 1 or 2-Pan sizes, not available for HWBI43 series) –

1-Pan Heated Well Cover (Overall: 14" W x 22" D x 2" H) –

1COVFUL-GGRAN	1 Heated Well Cover in Gray Granite	\$967
1COVFUL-BSAND	1 Heated Well Cover in Bermuda Sand	967
1COVFUL-NSKY	1 Heated Well Cover in Night Sky	967

2-Pan Heated Well Cover (Overall: 28" W x 22" D x 2" H) –

2COVFUL-GGRAN	2 Heated Well Cover in Gray Granite	\$1632
2COVFUL-BSAND	2 Heated Well Cover in Bermuda Sand	1632
2COVFUL-NSKY	2 Heated Well Cover in Night Sky	1632

HWBI-3
(3-pan size) with accessory heated well covers (one 1-pan heated well cover and one 2-pan heated well cover)



1COVFUL-GGRAN
accessory

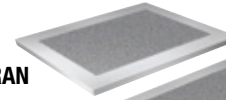

2COVFUL-GGRAN
accessory

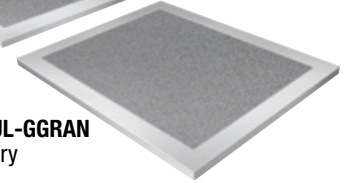

HEATED WELL COVER COMBINATIONS PER HWBI SERIES

Model Series	Using only: 1COVFUL	Model Series	Using both:	
			1COVFUL	2COVFUL
HWBI-1	1	HWBI-1	1	–
HWBI-2. -S2	2	HWBI-2	–	1
HWBI-3. -S3	3	HWBI-3	1	1
HWBI-4. -S4	4	HWBI-4	–	2
HWBI-5	5	HWBI-5	1	2
HWBI-6	6	HWBI-6	–	3

ADDITIONAL ACCESSORIES – PAGES 39-40
COLORS AND FINISHES – PAGE 241



HWB-2-11Q



HWB-3-4Q

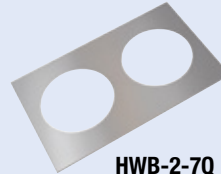

HWB-2-7Q

ADAPTERS – SUPPORT BARS

HWB-2-7Q	Adapter to convert warmer to hold two 7-Quart Inserts (HWBI and HWBI-S Modular Heated Wells only)	\$158
HWB-3-4Q	Adapter to convert warmer to hold three 4-Quart Inserts (HWBI and HWBI-S Modular Heated Wells only)	158
HWB-2-11Q	Adapter to convert warmer to hold two 11-Quart Inserts (HWBI43 Modular Heated Wells only)	198
HWBGM12BAR	12" Pan Support Bar for Drop-In Modular/Ganged Models	34
HWBGM20BAR	20" Pan Support Bar for Drop-In Modular/Ganged Models (not available for HWBI43 series)	40

HWB-2-7Q
shown with two 7QT-PAN and 7QT-LID-1



Support Bars
Choose the appropriate kit for HWBI or HWB series

MOUNTING KITS – VALVES

Necessary at your Well Installation –

HWB-MNT-REC Kit allows mounting to thick, non-combustible countertops - 8 Brackets **\$145**

External Manifold includes Individual Ball Valve for each Well (HWBI only, not available for the Slim models) –

HWBI2MANIF	2-Pan Accessory	\$1500
HWBI3MANIF	3-Pan Accessory	2128
HWBI4MANIF	4-Pan Accessory	2758
HWBI5MANIF	5-Pan Accessory	3386
HWBI6MANIF	6-Pan Accessory	4015

Necessary at your Well Installation –

BALLVALVE3/4	High Temperature 3/4" NPT Ball Valve for units with Individual Drain(s) and no Manifold	\$189
BALLVALVE1INCH	High Temperature 1" NPT Ball Valve for units with Manifold Drain	145
GATEVALVE3/4IN	High Temperature 3/4" NPT Gate Valve for units with Individual Drain(s) and no Manifold	218
GATEVALVE1INCH	High Temperature 1" NPT Gate Valve for units with Manifold Drain	322
HWB-RDHV	Heated Well Remote Handle for 3/4" Drains only and includes a Ball Valve	747

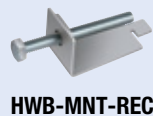

HWB-MNT-REC



HWBI2MANIF



BALLVALVE1INCH



GATEVALVE1INCH



HWB-RDHV
Attaches to 3/4" Drain and includes a Ball Valve



Individual Built-In Heated Wells Ordering Instructions

Please specify the following with each order:

1. **Desired Voltage:** 120, 208 or 240V
2. **Base Size of Heated Well:**
 - A. Rectangular:
Full (12" x 20") or 4/3 (12" x 27")
 - B. Round:
4-quart, 7-quart or 11-quart
3. **Drain** (with or without)
4. **Auto-fill** (with or without)
5. **Insulated or Uninsulated**



Insulated Well Construction
Full-size models are available with insulation for energy savings

6. **Mounting Style:**
 - A. Top Mounted
 - B. Bottom Mounted (rectangular full-size units only)
7. **Wattage:**
 - A. High watt
 - B. Standard watt
 - C. Low watt (120V only)

NOTE: Round Heated Wells are only available in standard and high watt configurations (4-quart available in standard watt only)
8. **Agency:**
 - A. C-UL
 - B. C-UR (C-UL Recognized – Conduit and Control Enclosure not included [fabricators will need to obtain approvals])
 - C. UL-EPH (sanitary listing)

CONTROL BOXES, COUNTERTOP CUT-OUT DIMENSIONS – PAGE 29

HWBIB-FULD
with accessory food pan

Thicker gauge steel construction means Hatco Heated Wells will last longer under the rigorous wear and tear of the foodservice industry

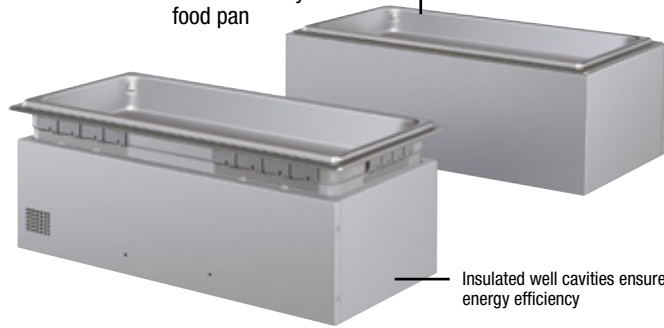

HWBI-FULD
with accessory food pan

Insulated well cavities ensure energy efficiency



HWB-FULD with accessory food pan (single unit holding 3 third-size pans unit depth is 21¾")

HWB-43D with accessory food pans (single unit holding 4 third-size pans – unit depth is 28⅝")



Easy to access the heating elements, if it ever becomes necessary to change them



Top Mounted Heated Well: Unit is mounted through the top surface of a sheet metal counter and secured with turn tabs (unit and food pan edge visible)



Bottom Mounted Heated Well: Full-size (only) unit is mounted to the bottom surface of a sheet metal counter and secured with customer provided turned bends and fasteners (only food pan edge visible)

HWBI-11QTDA
with accessory food pan



HWB-11QT
with accessory food pan



HWBI-7QTDA
with accessory food pan

HWB-7QT
with accessory food pan

HWB-4QT
with accessory food pan

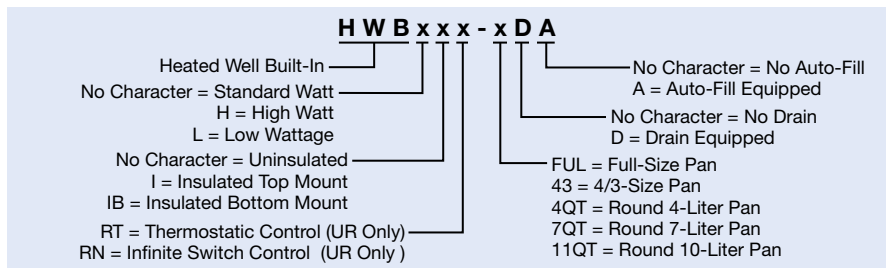



Individual Built-In Heated Wells Ordering Instructions

Options for Individual Built-In Heated Wells

- Control Box:**
 - Standard (compact) Thermostatic Control Box with Lighted On/Off Rocker Switch and Decorative Bezel. Can be front mounted or back mounted, and used with or without the Decorative Bezel (not available for auto-fill)
 - Optional Larger (front mounted) Recessed Thermostatic Control Box with Lighted On/Off Rocker Switch and Angled Recessed Controls for easy readability (not available for auto-fill)
 - Optional WM Control Assembly available that will replace most existing controls (not for auto-fill or Insulated Round Wells)
 - Optional ITC Control (not available for auto-fill, 4-quart Round Wells, Insulated Round Wells or low watt configurations)
 - Standard Control for auto-fill models only
- Control Type:**
 - Thermostatic
 - Infinite

NOTE: Infinite controls are only available on UR units
- Leads** – Extended high temp lead wire, per foot (1 foot standard)
- Thermostat** with 6' Capillary (3' standard)
- Corners**
 - Standard (Rounded)
 - Square Corners

Accessories for Individual Built-In Heated Wells

- Mounting Kits** for combustible countertops (individual drop-in top mount units only)
- Pan Support Bars:** 12" or 20"
- Adapters** to convert rectangular full-size units to hold 4- or 7-quart round pans, or 4/3-size units to hold 11-quart round pans
- Stainless Steel Pans:**
 - Third-size at 2½" deep (12¾"W x 6⅞"D x 2½"H)
 - Half-size at 2½" deep (12¾"W x 10⅞"D x 2½"H)
 - Full-size at 2½" deep (12¾"W x 20¾"D x 2½"H)
 - Full-size at 4" deep (12¾"W x 20¾"D x 4"H)
 - Full-size at 6" deep (12¾"W x 20¾"D x 6"H)
- Valve**
 - ¾" NPT Ball Valve for unit with Drain
 - ¾" NPT Gate Valve for unit with Drain

CONTROLS FOR UL and C-UL MODELS

STANDARD CONTROLS

Standard Thermostatic Control with bezel



STANDARD CONTROL AUTO-FILL

Standard Control (only for auto-fill)



OPTIONAL CONTROLS



WM Control Assembly (not for auto-fill or Insulated Round Wells)



ITC Control (Not available for 4-quart Round Wells, low watt configurations, auto-fill or Insulated Rounds Wells)



Larger Recessed Thermostatic Control

CONTROL CUTOUT DIMENSIONS

Control Box	Width	Height
Standard Thermostatic (with bezel)	3¼"	3¾"
Optional WM Control Assembly	4¾"	5"
Optional Larger Recessed		
Thermostatic	5⅞"	6⅝"
Optional ITC	5⅞"	6⅝"
Standard Control for Auto-fill	10⅞"	4¾"

FABRICATOR CONTROLS ONLY – UR and C-UR Components

"RT" added to model number indicates unit with thermostatic control, lit rocker switch and 36" capillary



"RN" added to model number indicates unit with infinite switch control, pilot light and 36" leads



CONTROL CUTOUT DIMENSIONS

Control	Width	Height
Thermostatic	2⅞"	3⅝"
Infinite	2⅞"	3⅝"

- Remote Handle** for ¾" Drains only and includes a Ball Valve

ACCESSORIES – PAGES 39-40

How to Order a Hatco® Heated Well in Video
Hatco has given you a variety of simple and easy ways to order your well. You can read the Ordering Instructions here or watch a video "How to Order a Hatco® Heated Well." Go to hatcocorp.com and click on the Video Library. While you are there, watch the "Hatco® Refrigerated Wells" video as well.



COMBUSTIBLE COUNTERTOP CUTOUTS – BUILT-IN AND DROP-IN HEATED WELLS

Model	Minimum Width	Maximum Width	Minimum Depth	Maximum Depth
HWB-FUL, -FULD, FULDA	14"	14¼"	22"	22¼"
HWBI-FUL, -FULD, FULDA	14"	14¼"	22"	22¼"
HWB-, HWBI-43	14"	14¼"	29"	29¼"
HWB-, HWBI-4QT	9"	9¼"	9"	9¼"
HWB-, HWBI-7QT	11"	11¼"	11"	11¼"
HWB-, HWBI-11QT	13"	13¼"	13"	13¼"

NON-COMBUSTIBLE COUNTERTOP CUTOUTS – BUILT-IN AND DROP-IN HEATED WELLS

Model	Minimum Width	Maximum Width	Minimum Depth	Maximum Depth
HWB-FUL, -FULD	12⅝"	12⅞"	20⅞"	20⅞"
HWB-FULDA	12⅝"	12⅞"	20⅞"	20⅞"
HWBI-FUL, -FULD	12¾"	12⅞"	20¾"	20⅞"
HWBI-FULDA®	12¾"	12⅞"	20⅞"	20⅞"
HWBIB-FUL®, -FULDA®	12⅞"	12⅞"	20⅞"	20⅞"
HWB-, HWBI-43	12⅞"	12⅞"	27⅞"	28"
HWB-4QT,	7⅞" Dia.	7⅞" Dia.	—	—
HWB-7QT	9⅞" Dia.	9⅞" Dia.	—	—
HWB-11QT	11⅞" Dia.	11⅞" Dia.	—	—
HWBI-4QT,	7⅞" Dia.	7⅞" Dia.	—	—
HWBI-7QT	9⅞" Dia.	9⅞" Dia.	—	—
HWBI-11QT	11⅞" Dia.	11⅞" Dia.	—	—

® Must be flanged.



Built-In Full-Size Heated Wells - C-UL Models

Hatco Built-in Heated Wells hold heated foods at safe-serving temperatures. Compared to other models, Hatco units offer a larger drain with a flat drain screen, more consistent holding temperatures, heavier stainless steel construction, easier-to-service design for quick change of components and a remote thermostat with separate power switch.

- Rectangular full-size only in top or bottom mount, insulated or uninsulated
- Low (120V only), standard and high watt
- Available with or without a drain (easy to clean with a larger drain and a flat screen)
- Easy access design allows for quick element or thermostat change
- Available with optional square corners in lieu of standard round corners
- Accessory mounting kits for combustible countertops available
- Accessory adapters to convert full-size wells to hold round pans

Control Options

- See page 29



HWB-FULD
with
accessory
food pan



HWBI-FULD
with accessory
food pan

HWBIB-FULD
with accessory
food pan

BUILT-IN FULL-SIZE RECTANGULAR C-UL WELLS

Model	Description	Dimensions W x D x H	Voltage	Watts	Approx. Ship Weight	List Price
Low Watt						
HWBL-FUL	Uninsulated Top or Bottom Mount	13 ¹ / ₁₆ " x 21 ³ / ₄ " x 9 ³ / ₈ "	120	750	22 lbs.	\$1406
HWBL-FULD	Uninsulated Top or Bottom Mount w/Drain	13 ¹ / ₁₆ " x 21 ³ / ₄ " x 9 ³ / ₈ "	120	750	22 lbs.	1485
HWBL-FULDA	Uninsulated Top or Bottom Mount w/Drain, Auto-fill	13 ¹ / ₁₆ " x 21 ³ / ₄ " x 9 ⁷ / ₁₆ "	120	765	21 lbs.	2697
HWBLI-FUL	Insulated Top or Bottom Mount	13 ¹ / ₁₆ " x 21 ³ / ₄ " x 10 ⁵ / ₁₆ "	120	750	30 lbs.	1599
HWBLI-FULD	Insulated Top or Bottom Mount w/Drain	13 ¹ / ₁₆ " x 21 ³ / ₄ " x 10 ⁵ / ₁₆ "	120	750	26 lbs.	1678
HWBLI-FULDA	Insulated Top Mount Only w/Drain, Auto-fill	13 ¹ / ₁₆ " x 21 ³ / ₄ " x 10 ³ / ₈ "	120	765	30 lbs.	2890
HWBLIB-FUL	Insulated Bottom Mount Only	13 ⁷ / ₈ " x 22 ¹ / ₈ " x 10 ⁵ / ₁₆ "	120	750	30 lbs.	1599
HWBLIB-FULD	Insulated Bottom Mount Only w/Drain	13 ⁷ / ₈ " x 22 ¹ / ₈ " x 10 ⁵ / ₁₆ "	120	750	29 lbs.	1678
HWBLIB-FULDA	Insulated Bottom Mount Only w/Drain, Auto-fill	13 ⁷ / ₈ " x 22 ¹ / ₈ " x 10 ⁵ / ₁₆ "	120	765	35 lbs.	2890
Standard Watt						
HWB-FUL	Uninsulated Top or Bottom Mount	13 ¹ / ₁₆ " x 21 ³ / ₄ " x 9 ³ / ₈ "	120, 208 or 240	1200	22 lbs.	\$1406
HWB-FULD	Uninsulated Top or Bottom Mount w/Drain	13 ¹ / ₁₆ " x 21 ³ / ₄ " x 9 ³ / ₈ "	120, 208 or 240	1200	22 lbs.	1485
HWB-FULDA	Uninsulated Top or Bottom Mount w/Drain, Auto-fill	13 ¹ / ₁₆ " x 21 ³ / ₄ " x 9 ⁷ / ₁₆ "	120, 208 or 240	1215	31 lbs.	2697
HWBI-FUL	Insulated Top or Bottom Mount	13 ¹ / ₁₆ " x 21 ³ / ₄ " x 10 ⁵ / ₁₆ "	120, 208 or 240	1200	26 lbs.	1599
HWBI-FULD	Insulated Top or Bottom Mount w/Drain	13 ¹ / ₁₆ " x 21 ³ / ₄ " x 10 ⁵ / ₁₆ "	120, 208 or 240	1200	25 lbs.	1678
HWBI-FULDA	Insulated Top Mount Only w/Drain, Auto-fill	13 ¹ / ₁₆ " x 21 ³ / ₄ " x 10 ³ / ₈ "	120, 208 or 240	1215	30 lbs.	2890
HWBIB-FUL	Insulated Bottom Mount Only	13 ⁷ / ₈ " x 22 ¹ / ₈ " x 10 ⁵ / ₁₆ "	120, 208 or 240	1200	28 lbs.	1599
HWBIB-FULD	Insulated Bottom Mount Only w/Drain	13 ⁷ / ₈ " x 22 ¹ / ₈ " x 10 ⁵ / ₁₆ "	120, 208 or 240	1200	28 lbs.	1678
HWBIB-FULDA	Insulated Bottom Mount Only w/Drain, Auto-fill	13 ⁷ / ₈ " x 22 ¹ / ₈ " x 10 ⁵ / ₁₆ "	120, 208 or 240	1215	35 lbs.	2890
High Watt						
HWBH-FUL	Uninsulated Top or Bottom Mount	13 ¹ / ₁₆ " x 21 ³ / ₄ " x 9 ³ / ₈ "	120, 208 or 240	1650	22 lbs.	\$1406
HWBH-FULD	Uninsulated Top or Bottom Mount w/Drain	13 ¹ / ₁₆ " x 21 ³ / ₄ " x 9 ³ / ₈ "	120, 208 or 240	1650	22 lbs.	1485
HWBH-FULDA	Uninsulated Top or Bottom Mount w/Drain, Auto-fill	13 ¹ / ₁₆ " x 21 ³ / ₄ " x 9 ⁷ / ₁₆ "	120, 208 or 240	1665	26 lbs.	2697
HWBHI-FUL	Insulated Top or Bottom Mount	13 ¹ / ₁₆ " x 21 ³ / ₄ " x 10 ⁵ / ₁₆ "	120, 208 or 240	1650	26 lbs.	1599
HWBHI-FULD	Insulated Top or Bottom Mount w/Drain	13 ¹ / ₁₆ " x 21 ³ / ₄ " x 10 ⁵ / ₁₆ "	120, 208 or 240	1650	31 lbs.	1678
HWBHI-FULDA	Insulated Top Mount Only w/Drain, Auto-fill	13 ¹ / ₁₆ " x 21 ³ / ₄ " x 10 ³ / ₈ "	120, 208 or 240	1665	30 lbs.	2890
HWBHIB-FUL	Insulated Bottom Mount Only	13 ⁷ / ₈ " x 22 ¹ / ₈ " x 10 ⁵ / ₁₆ "	120, 208 or 240	1650	30 lbs.	1599
HWBHIB-FULD	Insulated Bottom Mount Only w/Drain	13 ⁷ / ₈ " x 22 ¹ / ₈ " x 10 ⁵ / ₁₆ "	120, 208 or 240	1650	30 lbs.	1678
HWBHIB-FULDA	Insulated Bottom Mount Only w/Drain, Auto-fill	13 ⁷ / ₈ " x 22 ¹ / ₈ " x 10 ⁵ / ₁₆ "	120, 208 or 240	1665	35 lbs.	2890

All Built-In Full-Size Rectangular Heated Well Models Feature:

Voltage: Single phase.

Models Shipped with: EZ locking hardware for installation (top mounted only), 3' conduits between the control and well (except auto-fill unit) and a remote thermostat with lighted power switch.

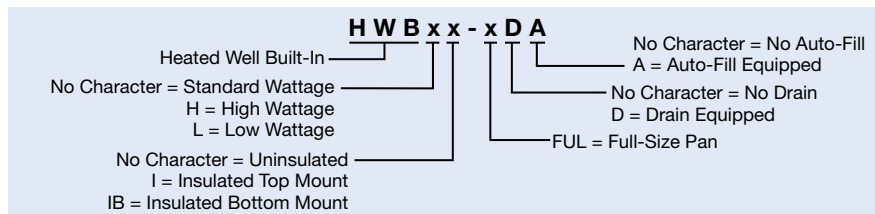

**COUNTERTOP CUT-OUT
DIMENSIONS – PAGE 29
OPTIONS – PAGE 31
ACCESSORIES – PAGES 39-40**



HWBL-43D and HWBLI-FULD with accessory food pans (shown with **GR2AHL** with standard *Designer* non-adjustable stands and optional *Designer* Black and sneeze guards)



Standard Thermostatic Control with control box bezel in optional *Designer Warm Red*



Heated & Cold Wells

OPTIONS (available at time of purchase only)

Designer Colors (Flush Mount Control Box Bezel, not available for Auto-fill or HWB-FUL w/cord) – Non-standard colors are non-returnable – Stainless Steel is standard –

RED	Warm Red	\$69
BLACK	Black	69
GRAY	Gray Granite	69
WHITE	White Granite	69
NAVY	Navy Blue	69
GREEN	Hunter Green	69
COPPER	Antique Copper	69
HWB-LEAD	Power Supply Lead Wire (Lead Wire only – Conduit not included)	per foot \$21
HWB-CORD	HWB-FUL with Cord Standard (Shown below) Not available for auto-fill models, low watt models available in 120V only	add 63
HWBI-CORD	HWBI-FUL with Cord Standard (Shown below) All models except Insulated Top Mount with auto-fill, low watt models are available in 120V only	add \$ 63
HWBIB-BRKT	Mounting Bracket for Insulated Bottom Mount (HWBIB series)	add 41
HWB-SQUARE	Square Pan Corners (In lieu of standard round pan corners)	add 157
Control Options –		
HWB-TSTAT	Thermostat with 6' Capillary (in lieu of standard 3', not available for auto-fill)	\$142
HWB-RTC	Larger Recessed Thermostatic Control Box (not available for auto-fill models)	No Charge
HWB-ITC	ITC Control with Large Control Box (not available for auto-fill, units without a drain or low watt configurations)	\$477
WM Assembly	Control Assembly Replacement (not available for auto-fill models)	No Charge

ACCESSORIES – PAGES 39-40
COLORS AND FINISHES – INSIDE BACK COVER

HWB-ITC –
Optional control (not available for auto-fill, units without a drain, or low watt configurations) shown in optional control box bezel in *Designer White Granite*

HWB-FUL with optional HWB-CORD



Square Corner



Standard Corner



HWB-FUL with optional HWB-TSTAT Thermostat with 6' capillary (Not available for auto-fill)



Drop-In 4/3-Size Heated Wells - C-UL Models

Convenient 4/3-Sized Wells hold heated foods at safe-serving temperatures. Like the full-size models, Hatco units offer a larger drain with a flat drain screen, more consistent holding temperatures, heavier stainless steel construction, easier-to-service design for quick change of components and a remote thermostat with separate power switch.

- Rectangular 4/3-size wells
- Low (120V only), standard and high watt
- Available with or without a drain (easy to clean with larger drain and flat screen)
- Easy access design allows for quick element or thermostat change
- Accessory mounting kits for combustible countertops available
- Accessory adapters to convert 4/3-size wells to hold round pans available

Control Options

- See page 29

HWB-43D with accessory food pans (single unit holding 4 third-size pans)



HWBI-43D with accessory food pans (single unit holding 4 third-size pans)



DROP-IN 4/3-SIZE RECTANGULAR C-UL WELLS

Model	Description	Dimensions W x D x H	Voltage	Watts	Approx. Ship Weight	List Price
Low Watt						
HWBL-43	Uninsulated	13 ³ / ₈ " x 28 ⁵ / ₈ " x 9 ⁷ / ₁₆ "	120	750	35 lbs.	\$1566
HWBL-43D	Uninsulated w/Drain	13 ³ / ₈ " x 28 ⁵ / ₈ " x 9 ⁷ / ₁₆ "	120	750	24 lbs.	1645
HWBL-43DA	Uninsulated w/Drain, Auto-fill	13 ³ / ₈ " x 28 ⁵ / ₈ " x 9 ⁷ / ₁₆ "	120	765	36 lbs.	2857
HWBLI-43	Insulated	13 ³ / ₈ " x 28 ⁵ / ₈ " x 10 ⁵ / ₁₆ "	120	750	33 lbs.	1759
HWBLI-43D	Insulated w/Drain	13 ³ / ₈ " x 28 ⁵ / ₈ " x 10 ⁵ / ₁₆ "	120	750	31 lbs.	1838
Standard Watt						
HWB-43	Uninsulated	13 ³ / ₈ " x 28 ⁵ / ₈ " x 9 ⁷ / ₁₆ "	120, 208 or 240	1200	24 lbs.	\$1566
HWB-43D	Uninsulated w/Drain	13 ³ / ₈ " x 28 ⁵ / ₈ " x 9 ⁷ / ₁₆ "	120, 208 or 240	1200	24 lbs.	1645
HWB-43DA	Uninsulated w/Drain, Auto-fill	13 ³ / ₈ " x 28 ⁵ / ₈ " x 9 ⁷ / ₁₆ "	120, 208 or 240	1215	27 lbs.	2857
HWBI-43	Insulated	13 ³ / ₈ " x 28 ⁵ / ₈ " x 10 ⁵ / ₁₆ "	120, 208 or 240	1200	30 lbs.	1759
HWBI-43D	Insulated w/Drain	13 ³ / ₈ " x 28 ⁵ / ₈ " x 10 ⁵ / ₁₆ "	120, 208 or 240	1200	31 lbs.	1838
High Watt						
HWBH-43	Uninsulated	13 ³ / ₈ " x 28 ⁵ / ₈ " x 9 ⁷ / ₁₆ "	120, 208 or 240	1650	24 lbs.	\$1566
HWBH-43D	Uninsulated w/Drain	13 ³ / ₈ " x 28 ⁵ / ₈ " x 9 ⁷ / ₁₆ "	120, 208 or 240	1650	24 lbs.	1645
HWBH-43DA	Uninsulated w/Drain, Auto-fill	13 ³ / ₈ " x 28 ⁵ / ₈ " x 9 ⁷ / ₁₆ "	120, 208 or 240	1665	30 lbs.	2857
HWBHI-43	Insulated	13 ³ / ₈ " x 28 ⁵ / ₈ " x 10 ⁵ / ₁₆ "	120, 208 or 240	1650	30 lbs.	1759
HWBHI-43D	Insulated w/Drain	13 ³ / ₈ " x 28 ⁵ / ₈ " x 10 ⁵ / ₁₆ "	120, 208 or 240	1650	30 lbs.	1838

All Drop-In 4/3-Size Rectangular Heated Well Models Feature:

Voltage: Single phase.

Models Shipped with: EZ locking hardware for installation, 3' conduits between the control and well (except auto-fill unit) and a remote thermostat with lighted power switch.

OPTIONS (available at time of purchase only)

HWB-LEAD	Power Supply Lead Wire (Lead Wire only - Conduit not included)	per foot \$21
HWB-AFL	Models HWB, HWBH, HWBL-43DA only - Left water fill hole (front is standard)	No Charge
HWB-AFR	Models HWB, HWBH, HWBL-43DA only - Right water fill hole (front is standard)	No Charge
Control Options -		
HWB-TSTAT	Thermostat with 6' Capillary (in lieu of standard 3', not available for auto-fill)	\$142
HWB-RTC	Larger Recessed Thermostatic Control Box (not available for auto-fill)	No Charge
WM Assembly	Control Assembly Replacement (not available for auto-fill models)	No Charge
HWB-ITC	ITC Control with Large Control Box (not available for auto-fill, units without a drain or low watt configurations)	\$477

Designer Colors (Control Box Bezel) -

Not available for Auto-fill -
Non-standard colors are non-returnable -
Stainless Steel is standard -

RED	Warm Red	\$69
BLACK	Black	69
GRAY	Gray Granite	69
WHITE	White Granite	69
NAVY	Navy Blue	69
GREEN	Hunter Green	69
COPPER	Antique Copper	69

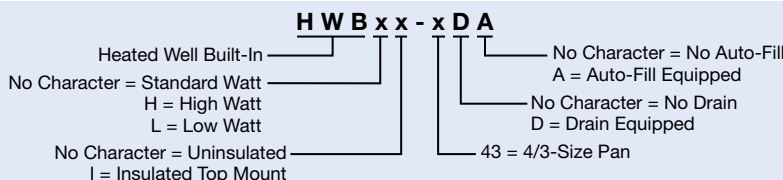

COUNTERTOP CUT-OUT DIMENSIONS - PAGE 29
ACCESSORIES - PAGES 39-40
COLORS AND FINISHES - PAGE 241



Drop-In Round Uninsulated Heated Wells - C-UL Models

Keeping hot food at safe-serving temperatures is critical to any foodservice operation – and Hatco has the Heated Wells to meet the demands of any serving application. Thermostatic controls monitor and regulate the temperature of the well for more accurate heat and energy savings. Hatco controls feature a separate On/Off switch, which allows a previously determined setting to be maintained.

- 4-, 7- and 11-quart Round Wells
- Standard or high watt (4-quart standard watt only)
- With or without drain
- EZ locking hardware for easy top mount installation
- Accessory mounting kits for combustible countertops available

HWB-7QT with accessory food pan



HWB-11QT with accessory food pan

HWB-4QT with accessory food pan

Control Options

- Standard (compact) thermostatic control box with lighted On/Off rocker switch and decorative bezel. Can be front mounted or back mounted, and used with or without the decorative bezel
- Optional larger (front mounted) recessed thermostatic control box with lighted On/Off rocker switch and angled recessed controls for easy readability
- Optional WM control assembly available to replace most existing controls on a customer's Drop-In Heated Well unit for easier reading
- Optional ITC control with large control box available for easier reading on 7- or 11-quart standard or high watt configurations

Quick-Ship Program Information Inside Back Cover

DROP-IN ROUND C-UL WELLS – UNINSULATED

Model	Description	Dimensions Dia. x H	Watts			Approx. Ship Weight	List Price
			120V	208V	240V		
4-Quart – Standard Watt							
HWB-4QT	Top Mount	8 ³ / ₁₆ " x 10 ⁵ / ₁₆ "	500	536	600	11 lbs.	\$1337
HWB-4QTD	Top Mount w/Drain	8 ³ / ₁₆ " x 10 ⁵ / ₁₆ "	500	536	600	10 lbs.	1416
7-Quart – Standard Watt							
✓ HWB-7QT	Top Mount	10 ⁵ / ₁₆ " x 9 ⁹ / ₁₆ "	500	536	600	12 lbs.	\$1337
✓ HWB-7QTD	Top Mount w/Drain	10 ⁵ / ₁₆ " x 9 ⁹ / ₁₆ "	500	536	600	12 lbs.	1416
7-Quart – High Watt							
HWBH-7QT	Top Mount	10 ⁵ / ₁₆ " x 9 ⁹ / ₁₆ "	800	715	800	12 lbs.	\$1337
HWBH-7QTD	Top Mount w/Drain	10 ⁵ / ₁₆ " x 9 ⁹ / ₁₆ "	800	715	800	12 lbs.	1416
11-Quart – Standard Watt							
✓ HWB-11QT	Top Mount	12 ⁵ / ₁₆ " x 9 ⁹ / ₁₆ "	500	536	600	13 lbs.	\$1337
✓ HWB-11QTD	Top Mount w/Drain	12 ⁵ / ₁₆ " x 9 ⁹ / ₁₆ "	500	536	600	14 lbs.	1416
11-Quart – High Watt							
HWBH-11QT	Top Mount	12 ⁵ / ₁₆ " x 9 ⁹ / ₁₆ "	800	715	800	13 lbs.	\$1337
✓ HWBH-11QTD	Top Mount w/Drain	12 ⁵ / ₁₆ " x 9 ⁹ / ₁₆ "	800	715	800	13 lbs.	1416



Optional larger recessed thermostatic control



Standard thermostatic control with bezel



WM control assembly



Optional ITC control – (not for 4-quart Round Wells or units without drains) shown in optional control box bezel in Designer White Granite

All Drop-In Round Heated Well Models Feature:

Voltage: Single phase.

Models Shipped with: EZ locking hardware for installation, 3' conduits between the control and well and a remote thermostat with lighted power switch.

OPTIONS (available at time of purchase only)

HWB-LEAD	Power Supply Lead Wire (Lead Wire only – Conduit not included)	per foot \$21
HWB-CORD	Optional cord available on models attached to control box in lieu of conduit and lead wire (120V only)	add 63
Control Options –		
HWB-TSTAT	Thermostat with 6' Capillary (in lieu of standard 3', not available for auto-fill)	\$142
HWB-RTC	Larger Recessed Thermostatic Control Box (not available for auto-fill)	No Charge
WM Assembly	Control Assembly Replacement	No Charge
HWB-ITC	ITC Control with Large Control Box for 7- and 11-Quart Drop-In Round Wells only	\$477

Designer Colors (Control Box Bezel) – Non-standard colors are non-returnable – Stainless Steel is standard –

RED	Warm Red	\$69
BLACK	Black	69
GRAY	Gray Granite	69
WHITE	White Granite	69
NAVY	Navy Blue	69
GREEN	Hunter Green	69
COPPER	Antique Copper	69

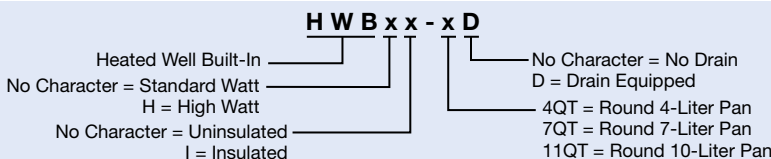

COUNTERTOP CUT-OUT DIMENSIONS – PAGE 29
ACCESSORIES – PAGES 39-40
COLORS AND FINISHES – PAGE 241



Drop-In Round Insulated Heated Wells – C-UL Models

Hatco Drop-In Round Insulated Heated Wells provide flexibility and quality, with many options to choose from. These units hold steam table food hot and fresh with self-adjusting thermostats that monitor the actual temperatures and control the heat only when needed.

- Available in insulated 4-, 7- and 10-liter Round Wells
- Standard or high watt (4-liter standard watt only)
- Controls feature a separate lighted ON/OFF rocker switch and temperature dial, allowing preset temperatures to be maintained
- Easy service access to heating elements and thermostats
- Mounting kits for combustible countertops available
- Auto-Fill models available in 7 and 10 liter round wells

Control Options

- Larger front-mounted recessed thermostatic control box with lighted On/Off rocker switch and angled recessed controls for easy readability



Larger recessed thermostatic control at no charge

HWBI-7QTDA with accessory food pan



HWBI-11QTDA with accessory food pan

DROP-IN ROUND C-UL WELLS – INSULATED

Model	Description	Dimensions Dia. x H	Watts			Approx. Ship Weight	List Price
			120V	208V	240V		
4-Liter (4-Quart) – Standard Watt							
HWBI-4QT	Top Mount	8 ³ / ₁₆ " x 10 ¹ / ₁₆ "	500	536	600	12 lbs.	\$1530
HWBI-4QTD	Top Mount w/Drain	8 ³ / ₁₆ " x 10 ¹ / ₁₆ "	500	536	600	13 lbs.	1609
7-Liter (7-Quart) – Standard Watt							
HWBI-7QT	Top Mount	10 ⁵ / ₁₆ " x 9 ³ / ₄ "	500	536	600	12 lbs.	\$1530
HWBI-7QTD	Top Mount w/Drain	10 ⁵ / ₁₆ " x 9 ³ / ₄ "	500	536	600	15 lbs.	1609
HWBI-7QTDA	Top Mount w/Drain, Auto-fill	10 ⁵ / ₁₆ " x 9 ³ / ₄ "	515	551	615	15 lbs.	2821
7-Liter (7-Quart) – High Watt							
HWBHI-7QT	Top Mount	10 ⁵ / ₁₆ " x 9 ³ / ₄ "	800	715	800	13 lbs.	\$1530
HWBHI-7QTD	Top Mount w/Drain	10 ⁵ / ₁₆ " x 9 ³ / ₄ "	800	715	800	15 lbs.	1609
HWBHI-7QTDA	Top Mount w/Drain, Auto-fill	10 ⁵ / ₁₆ " x 9 ³ / ₄ "	815	730	815	19 lbs.	2821
10-Liter (11-Quart) – Standard Watt							
HWBI-11QT	Top Mount	12 ⁵ / ₁₆ " x 9 ³ / ₄ "	500	536	600	16 lbs.	\$1530
HWBI-11QTD	Top Mount w/Drain	12 ⁵ / ₁₆ " x 9 ³ / ₄ "	500	536	600	21 lbs.	1609
HWBI-11QTDA	Top Mount w/Drain, Auto-fill	12 ⁵ / ₁₆ " x 9 ³ / ₄ "	515	551	615	23 lbs.	2821
10-Liter (11-Quart) – High Watt							
HWBHI-11QT	Top Mount	12 ⁵ / ₁₆ " x 9 ³ / ₄ "	800	715	800	16 lbs.	\$1530
HWBHI-11QTD	Top Mount w/Drain	12 ⁵ / ₁₆ " x 9 ³ / ₄ "	800	715	800	16 lbs.	1609
HWBHI-11QTDA	Top Mount w/Drain, Auto-fill	12 ⁵ / ₁₆ " x 9 ³ / ₄ "	815	730	815	27 lbs.	2821

All Drop-In Round Insulated Heated Well Models Feature:

Voltage: Single phase.

Models Shipped with: EZ locking hardware for installation, 914 mm (36") conduit and a remote thermostat with lighted power switch.

OPTIONS (available at time of purchase only)

HWB-LEAD	Power Supply Lead Wire (Lead Wire only – Conduit not included)	per foot \$21
HWBI-CORD	Optional cord available on models attached to control box in lieu of conduit and lead wire (120V only)	add 63
Control Options –		
HWB-TSTAT	Thermostat with 6' Capillary (in lieu of standard 3', not available for auto-fill)	\$142
HWB-RTC	Larger Recessed Thermostatic Control (not available for auto-fill)	No Charge

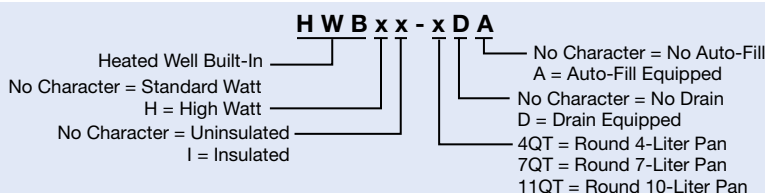

**COUNTERTOP CUT-OUT DIMENSIONS – PAGE 29
 ACCESSORIES – PAGES 39-40**



Built-In Full-Size Heated Wells - C-UR Components

Having all the same great features as all of the Hatco Heated Wells family, these models allow fabricators the freedom to design their own steam tables with UL recognized components. And Hatco Heated Wells hold hot food at safe-serving temperatures.

- Without conduit and control box enclosure
- Thermostatic or infinite controls available (infinite switch option not available on 120V high watt)
- With or without drains
- Low, standard and high watt models
- Available with optional square corners in lieu of standard round corners



HWBRT-FUL with accessory food pan

Control Options

- See page 29

HWBIBRT-FULD with accessory food pan



HWBIBRT-FULD with accessory food pan

NOTE: Fabricators will need to obtain approvals.

BUILT-IN FULL-SIZE RECTANGULAR WELLS - C-UR COMPONENTS

Model [■]	Description	Dimensions W x D x H	Voltage	Watts	Approx. Ship Weight	List Price
Low Watt						
HWBLRT-FUL	Uninsulated Top or Bottom Mount	13 ¹¹ / ₁₆ " x 21 ³ / ₄ " x 9 ³ / ₈ "	120	750	21 lbs.	\$1276
HWBLRT-FULD	Uninsulated Top or Bottom Mount w/Drain	13 ¹¹ / ₁₆ " x 21 ³ / ₄ " x 9 ³ / ₈ "	120	750	20 lbs.	1355
HWBLRN-FUL	Uninsulated Top or Bottom Mount	13 ¹¹ / ₁₆ " x 21 ³ / ₄ " x 9 ³ / ₈ "	120	750	19 lbs.	1276
HWBLRN-FULD	Uninsulated Top or Bottom Mount w/Drain	13 ¹¹ / ₁₆ " x 21 ³ / ₄ " x 9 ³ / ₈ "	120	750	20 lbs.	1355
HWBLIRT-FUL	Insulated Top or Bottom Mount	13 ¹¹ / ₁₆ " x 21 ³ / ₄ " x 10 ⁵ / ₁₆ "	120	750	27 lbs.	1469
HWBLIRT-FULD	Insulated Top or Bottom Mount w/Drain	13 ¹¹ / ₁₆ " x 21 ³ / ₄ " x 10 ⁵ / ₁₆ "	120	750	19 lbs.	1548
HWBLIBRT-FUL	Insulated Bottom Mount Only	13 ⁷ / ₈ " x 22 ¹ / ₈ " x 10 ⁵ / ₁₆ "	120	750	28 lbs.	1469
HWBLIBRT-FULD	Insulated Bottom Mount Only w/Drain	13 ⁷ / ₈ " x 22 ¹ / ₈ " x 10 ⁵ / ₁₆ "	120	750	26 lbs.	1548
Standard Watt						
HWBRT-FUL	Uninsulated Top or Bottom Mount	13 ¹¹ / ₁₆ " x 21 ³ / ₄ " x 9 ³ / ₈ "	120, 208 or 240	1200	19 lbs.	\$1276
HWBRT-FULD	Uninsulated Top or Bottom Mount w/Drain	13 ¹¹ / ₁₆ " x 21 ³ / ₄ " x 9 ³ / ₈ "	120, 208 or 240	1200	20 lbs.	1355
HWBRN-FUL	Uninsulated Top or Bottom Mount	13 ¹¹ / ₁₆ " x 21 ³ / ₄ " x 9 ³ / ₈ "	120, 208 or 240	1200	19 lbs.	1276
HWBRN-FULD	Uninsulated Top or Bottom Mount w/Drain	13 ¹¹ / ₁₆ " x 21 ³ / ₄ " x 9 ³ / ₈ "	120, 208 or 240	1200	20 lbs.	1355
HWBIRT-FUL	Insulated Top or Bottom Mount	13 ¹¹ / ₁₆ " x 21 ³ / ₄ " x 10 ⁵ / ₁₆ "	120, 208 or 240	1200	24 lbs.	1469
HWBIRT-FULD	Insulated Top or Bottom Mount w/Drain	13 ¹¹ / ₁₆ " x 21 ³ / ₄ " x 10 ⁵ / ₁₆ "	120, 208 or 240	1200	26 lbs.	1548
HWBIBRT-FUL	Insulated Bottom Mount Only	13 ⁷ / ₈ " x 22 ¹ / ₈ " x 10 ⁵ / ₁₆ "	120, 208 or 240	1200	26 lbs.	1469
HWBIBRT-FULD	Insulated Bottom Mount Only w/Drain	13 ⁷ / ₈ " x 22 ¹ / ₈ " x 10 ⁵ / ₁₆ "	120, 208 or 240	1200	26 lbs.	1548
High Watt						
HWBHRT-FUL	Uninsulated Top or Bottom Mount	13 ¹¹ / ₁₆ " x 21 ³ / ₄ " x 9 ³ / ₈ "	120, 208 or 240	1650	21 lbs.	\$1276
HWBHRT-FULD	Uninsulated Top or Bottom Mount w/Drain	13 ¹¹ / ₁₆ " x 21 ³ / ₄ " x 9 ³ / ₈ "	120, 208 or 240	1650	18 lbs.	1355
HWBHRN-FUL	Uninsulated Top or Bottom Mount	13 ¹¹ / ₁₆ " x 21 ³ / ₄ " x 9 ³ / ₈ "	208 or 240	1650	21 lbs.	1276
HWBHRN-FULD	Uninsulated Top or Bottom Mount w/Drain	13 ¹¹ / ₁₆ " x 21 ³ / ₄ " x 9 ³ / ₈ "	208 or 240	1650	20 lbs.	1355
HWBHIRT-FUL	Insulated Top or Bottom Mount	13 ¹¹ / ₁₆ " x 21 ³ / ₄ " x 10 ⁵ / ₁₆ "	120, 208 or 240	1650	26 lbs.	1469
HWBHIRT-FULD	Insulated Top or Bottom Mount w/Drain	13 ¹¹ / ₁₆ " x 21 ³ / ₄ " x 10 ⁵ / ₁₆ "	120, 208 or 240	1650	28 lbs.	1548
HWBHIBRT-FUL	Insulated Bottom Mount Only	13 ⁷ / ₈ " x 22 ¹ / ₈ " x 10 ⁵ / ₁₆ "	120, 208 or 240	1650	28 lbs.	1469
HWBHIBRT-FULD	Insulated Bottom Mount Only w/Drain	13 ⁷ / ₈ " x 22 ¹ / ₈ " x 10 ⁵ / ₁₆ "	120, 208 or 240	1650	28 lbs.	1548

■ "RT" added to model name indicates unit with thermostat control, lit rocker switch and 36" capillary.
 "RN" added to model name indicates unit with infinite switch control, pilot light and 36" leads.

All Built-In Full-Size Rectangular C-UR Heated Well Models Feature:

Voltage: Single phase.

Models Shipped with: EZ locking hardware for installation (top mounted only).

OPTIONS (available at time of purchase only), C-UR COMPONENTS ONLY

HWB-LEAD-UR	Power Supply Lead Wire for "RN" Components (Lead Wire only - Conduit not included)	per foot \$ 21
HWB-SQUARE	Square Pan Corners (In lieu of standard round pan corners)	add 157
Control Options -		
HWB-TSTAT-UR	Thermostat with 6' Capillary for "RT" Components (in lieu of standard 3', Thermostat only - Conduit not included)	\$101

Standard Corner



Square Corner

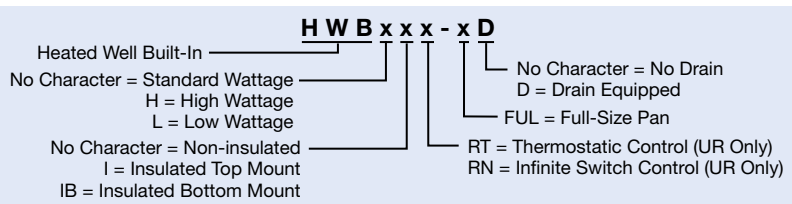

COUNTERTOP CUT-OUT DIMENSIONS - PAGE 29
ACCESSORIES - PAGES 39-40



Drop-In 4/3-Size Heated Wells - C-UR Components

Having the same great features as all of the Hatco Heated Wells, plus the added benefit of allowing fabricators the freedom to design their own steam tables with UL recognized components, these units hold hot food products at safe-serving temperatures.

- Without conduit and control box enclosure
- Thermostatic or infinite controls available (infinite switch option not available on 120V high watt)
- With or without drains
- Low, standard and high watt models



HWBRT-43D with accessory food pans (single unit can hold 4 third-size pans)

Control Options

The C-UR models can have the following control choices:

- Thermostatic controls, which feature an On/Off switch with light
- Infinite controls – available with indicator light (infinite switch option not available on 120V high watt)



Thermostatic control



Infinite control

CONTROL CUTOUT DIMENSIONS

Control	Width	Height
Thermostatic	2 1/8"	3 3/8"
Infinite	2 1/8"	3 3/8"

NOTE: Fabricators will need to obtain approvals.

DROP-IN 4/3-SIZE RECTANGULAR WELLS – C-UR COMPONENTS

Model #	Description	Dimensions W x D x H	Voltage	Watts	Approx. Ship Weight	List Price
Low Watt						
HWBLRT-43	Uninsulated	13 3/8" x 28 5/8" x 9 3/8"	120	750	30 lbs.	\$1436
HWBLRT-43D	Uninsulated w/Drain	13 3/8" x 28 5/8" x 9 3/8"	120	750	33 lbs.	1515
HWBLRN-43	Uninsulated	13 3/8" x 28 5/8" x 9 3/8"	120	750	21 lbs.	1436
HWBLRN-43D	Uninsulated w/Drain	13 3/8" x 28 5/8" x 9 3/8"	120	750	33 lbs.	1515
Standard Watt						
HWBRT-43	Uninsulated	13 3/8" x 28 5/8" x 9 3/8"	120, 208 or 240	1200	23 lbs.	\$1436
HWBRT-43D	Uninsulated w/Drain	13 3/8" x 28 5/8" x 9 3/8"	120, 208 or 240	1200	21 lbs.	1515
HWBRN-43	Uninsulated	13 3/8" x 28 5/8" x 9 3/8"	120, 208 or 240	1200	21 lbs.	1436
HWBRN-43D	Uninsulated w/Drain	13 3/8" x 28 5/8" x 9 3/8"	120, 208 or 240	1200	21 lbs.	1515
High Watt						
HWBHRT-43	Uninsulated	13 3/8" x 28 5/8" x 9 3/8"	120, 208 or 240	1650	30 lbs.	\$1436
HWBHRT-43D	Uninsulated w/Drain	13 3/8" x 28 5/8" x 9 3/8"	120, 208 or 240	1650	21 lbs.	1515
HWBHRN-43	Uninsulated	13 3/8" x 28 5/8" x 9 3/8"	208 or 240	1650	30 lbs.	1436
HWBHRN-43D	Uninsulated w/Drain	13 3/8" x 28 5/8" x 9 3/8"	208 or 240	1650	33 lbs.	1515

- "RT" added to model name indicates unit with thermostat control, lit rocker switch and 36" capillary.
- "RN" added to model name indicates unit with infinite switch control, pilot light and 36" leads.

All Drop-In 4/3-Size Rectangular C-UR Heated Well Models Feature:

Voltage: Single phase.

Models Shipped with: EZ locking hardware for installation.

OPTIONS (available at time of purchase only), C-UR COMPONENTS ONLY

HWB-LEAD-UR	Power Supply Lead Wire for "RN" Components (Lead Wire only – Conduit not included)	per foot \$21
Control Options –		
HWB-TSTAT-UR	Thermostat with 6' Capillary for "RT" Components (in lieu of standard 3', Thermostat only – Conduit not included)	\$101

HWB x x - x D

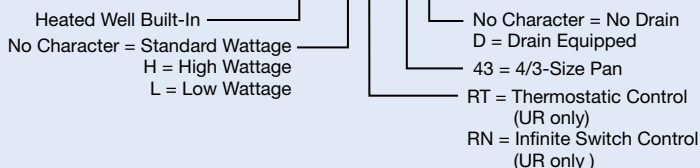

COUNTERTOP CUT-OUT DIMENSIONS – PAGE 29
ACCESSORIES – PAGES 39-40



Drop-In Round Heated Wells – C-UR Components

Ideal for the fabricator who wants to design a specific steam table layout. Easy to install, and easy to service, the Round Heated Wells come with control, size, drain and wattage choices.

- 4-, 7- and 11-quart Round Heated Wells
- Standard or high watt (4-quart standard watt only)
- With or without drain
- Thermostatic or infinite controls available
- Without conduit and control box enclosure

HWBRT-7QT with accessory food pan (not included)



HWBRT-11QT with accessory food pan (not included)

HWBRT-4QT with accessory food pan (not included)

Heated & Cold Wells

NOTE: Fabricators will need to obtain approvals.

DROP-IN ROUND WELLS – C-UR COMPONENTS – UNINSULATED

Model #	Description	Dimensions Dia. x H	Watts			Approx. Ship Weight	List Price
			120V	208V	240V		
4-Quart – Standard Watt							
HWBRT-4QT	Top Mount	8 3/8" x 10 5/8"	500	536	600	9 lbs.	\$1207
HWBRT-4QTD	Top Mount w/Drain	8 3/8" x 10 5/8"	500	536	600	9 lbs.	1286
HWBRN-4QT	Top Mount	8 3/8" x 10 5/8"	500	536	600	6 lbs.	1207
HWBRN-4QTD	Top Mount w/Drain	8 3/8" x 10 5/8"	500	536	600	10 lbs.	1286
7-Quart – Standard Watt							
HWBRT-7QT	Top Mount	10 5/16" x 9 9/8"	500	536	600	11 lbs.	\$1207
HWBRT-7QTD	Top Mount w/Drain	10 5/16" x 9 9/8"	500	536	600	11 lbs.	1286
HWBRN-7QT	Top Mount	10 5/16" x 9 9/8"	500	536	600	7 lbs.	1207
HWBRN-7QTD	Top Mount w/Drain	10 5/16" x 9 9/8"	500	536	600	10 lbs.	1286
7-Quart – High Watt							
HWBHRT-7QT	Top Mount	10 5/16" x 9 9/8"	800	715	800	11 lbs.	\$1207
HWBHRT-7QTD	Top Mount w/Drain	10 5/16" x 9 9/8"	800	715	800	9 lbs.	1286
HWBHRN-7QT	Top Mount	10 5/16" x 9 9/8"	800	715	800	7 lbs.	1207
HWBHRN-7QTD	Top Mount w/Drain	10 5/16" x 9 9/8"	800	715	800	13 lbs.	1286
11-Quart – Standard Watt							
HWBRT-11QT	Top Mount	12 5/16" x 9 9/8"	500	536	600	10 lbs.	\$1207
HWBRT-11QTD	Top Mount w/Drain	12 5/16" x 9 9/8"	500	536	600	11 lbs.	1286
HWBRN-11QT	Top Mount	12 5/16" x 9 9/8"	500	536	600	10 lbs.	1207
HWBRN-11QTD	Top Mount w/Drain	12 5/16" x 9 9/8"	500	536	600	11 lbs.	1286
11-Quart – High Watt							
HWBHRT-11QT	Top Mount	12 5/16" x 9 9/8"	800	715	800	15 lbs.	\$1207
HWBHRT-11QTD	Top Mount w/Drain	12 5/16" x 9 9/8"	800	715	800	11 lbs.	1286
HWBHRN-11QT	Top Mount	12 5/16" x 9 9/8"	800	715	800	10 lbs.	1207
HWBHRN-11QTD	Top Mount w/Drain	12 5/16" x 9 9/8"	800	715	800	13 lbs.	1286

- "RT" added to model name indicates unit with thermostat control, lit rocker switch and 36" capillary.
- "RN" added to model name indicates unit with infinite switch control, pilot light and 36" leads.

All Drop-In Round C-UR Heated Well Models Feature:

Voltage: Single phase.

Models Shipped with: EZ locking hardware for installation.

Control Options

The C-UR models can have the following control choices:

- Thermostatic controls, which feature an On/Off switch with light
- Infinite controls – available with indicator light



Thermostatic control



Infinite control

CONTROL CUTOUT DIMENSIONS

Control	Width	Height
Thermostatic	2 1/8"	3 3/8"
Infinite	2 1/8"	3 3/8"

OPTIONS (available at time of purchase only), C-UR COMPONENTS ONLY

HWB-LEAD-UR	Power Supply Lead Wire for "RN" Components (Lead Wire only – Conduit not included)	per foot \$21
Control Options –		
HWB-TSTAT-UR	Thermostat with 6' Capillary for "RT" Components (in lieu of standard 3', Thermostat only – Conduit not included)	\$101

COUNTERTOP CUT-OUT DIMENSIONS – PAGE 29 ACCESSORIES – PAGES 39-40

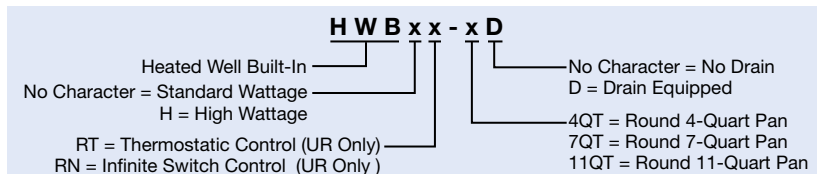



Remote Drop-In Hot/Cold Wells

Whether it is breakfast in the morning or a salad bar at lunch, this well incorporates the legendary quality of both the hot and cold units into one, but in a remote configuration that offers unlimited flexibility for your own particular dining design needs.

HCWBIR-2DA

shown with condensing unit (shipped loose), control panel and accessory food pans and pan support bars



Standard features

- Can house a variety of pans, full-size, half-size or third-size and are available in a two through six pan configuration
- Cold Mode: Similar to Hatco's CWB Cold Well, including auto-defrost, easy serviceability, optimal insulation and efficient condenser. Includes cold mode pan supports
- Hot Mode: Utilizes the same time-tested FR2 Hydro-Heater (Bain Marie) with "free flow" technology for an efficient and safe operation with a longer life, and includes drain, auto-fill and hot mode frame for pan support

• HCWBIR-xx models only:

- Condenser utilizes R-513A refrigerant
- Includes a condensing unit (shipped loose - can be field mounted up to 50' of tubing from unit), an attached FR2 Hydro-Heater, control panel and TXV valve (TXV is shipped loose)

• HCWBIX-xx models only:

- Includes control panel and FR2 Hydro-Heater but without a condensing unit for the increased flexibility of multiple hot/cold well configurations
- Solenoid valve attached to cold well with a TXV valve (TXV is shipped loose)

HCWBIX-2DA

shown with control panel and accessory food pans and pan support bars



DROP-IN HOT/COLD WELLS – WITH CONDENSING UNIT AND REMOTE CONTROL PANEL

Model	Dimensions W x D x H	HP	Watts Hot Mode	Approx. Ship Weight	List Price			
					120/208V		120/240V	
					Single Phase	Three Phase	Single Phase	Three Phase
HCWBIR-2DA	32" x 27" x 26 5/8"	1/5	3000	214 lbs.	\$20455	\$21936	—	\$19253
HCWBIR-3DA	45" x 27" x 26 5/8"	1/5	3000	237 lbs.	21102	22583	—	19818
HCWBIR-4DA	58" x 27" x 26 5/8"	1/3	4000	285 lbs.	21992	23473	\$21992	23473
HCWBIR-5DA	71" x 27" x 26 5/8"	5/8	6000	343 lbs.	24815	26296	—	23060
HCWBIR-6DA	84" x 27" x 26 5/8"	5/8	6000	370 lbs.	27556	29037	—	25453

All models utilize R-513A Refrigerant.

All Remote Drop-In Hot/Cold Well Models with a Condensing Unit and Remote Control Feature:

Models Shipped with: Remote-mounted control box, remote-mounted condensing unit and a TXV valve (shipped loose).

DROP-IN HOT/COLD WELLS – WITH REMOTE CONTROL PANEL (without a condensing unit)

Model	Dimensions W x D x H	Load/BTU Hour	Hz	Approx. Ship Weight	List Price			
					120/208V		120/240V	
					Single Phase	Three Phase	Single Phase	Three Phase
HCWBIX-2DA	32" x 27" x 26 5/8"	630	60	165 lbs.	\$18725	\$20206	—	\$17743
HCWBIX-3DA	45" x 27" x 26 5/8"	930	60	188 lbs.	19375	20856	—	18310
HCWBIX-4DA	58" x 27" x 26 5/8"	1230	60	235 lbs.	20255	21736	\$20255	21736
HCWBIX-5DA	71" x 27" x 26 5/8"	1530	60	268 lbs.	22594	24075	—	21121
HCWBIX-6DA	84" x 27" x 26 5/8"	1830	60	295 lbs.	25333	26814	—	23513

All models utilize R-513A Refrigerant.

All Remote Drop-In Hot/Cold Well Models with a Remote Control (without a Condensing Unit) Feature:

Models Shipped with: Remote-mounted control box, a TXV valve (shipped loose) and a solenoid valve attached to well.

OPTIONS AND ACCESSORIES – PAGE 39 PANS AND TRIVET ACCESSORIES – PAGE 50

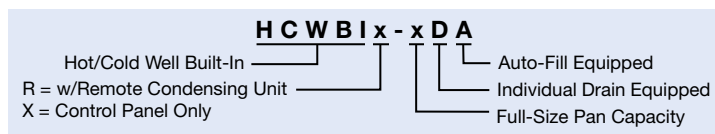

DROP-IN HOT/COLD WELLS COUNTERTOP CUT-OUTS

Model	Minimum Width	Maximum Width	Minimum Depth	Maximum Depth
HCWBI-2DA	30 1/8"	31"	25 3/16"	26"
HCWBI-3DA	43 3/8"	44"	25 3/16"	26"
HCWBI-4DA	56 1/8"	57"	25 3/16"	26"
HCWBI-5DA	69 1/8"	70"	25 3/16"	26"
HCWBI-6DA	82 1/8"	83"	25 3/16"	26"

Remote Drop-In Hot/Cold Well Options and Accessories

OPTIONS (available at time of purchase only)

EWC	Additional Four Year Parts Only Warranty on the Compressor (HCWBI and HCWBIR series only)	\$275
Gasket Options –		
BEZELGASKET-2	Factory installed for HCWBI-, HCWBIR- and HCWBIX-2DA	\$138
BEZELGASKET-3	Factory installed for HCWBI-, HCWBIR- and HCWBIX-3DA	180
BEZELGASKET-4	Factory installed for HCWBI-, HCWBIR- and HCWBIX-4DA	180
BEZELGASKET-5	Factory installed for HCWBI-, HCWBIR- and HCWBIX-5DA	194
BEZELGASKET-6	Factory installed for HCWBI-, HCWBIR- and HCWBIX-6DA	194

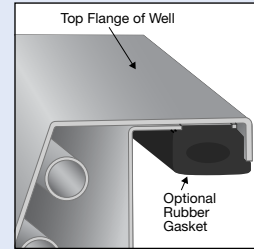

BEZELGASKET-2, -3, -4, -5, -6
Factory installed option (eliminates the need for silicone or other sealants)

ACCESSORIES (available for purchase at any time)

FR2-FLUSH	Flush Hose, Cleaning Brush, Stopper and Adapter	\$167
CWB12BAR	12" Pan Support for Drop-In Refrigerated Wells	36
CWB20BAR	20" Pan Support for Drop-In Refrigerated Wells	41

ADDITIONAL ACCESSORIES – PAGE 24



Support Bars

Choose the appropriate kit for HCWBI series



Remote Drop-In Hot/Cold Well and Individual Built-In Heated Well Accessories

(available for purchase at any time)



PANS – LIDS – TRIVETS

ST PAN 1/3	Third-Size Stainless Steel Pan – 12¾"W x 6⅞"D x 2½"H	\$101
ST PAN 1/2	Half-Size Stainless Steel Pan – 12¾"W x 10⅜"D x 2½"H	116
ST PAN 2	Full-Size Stainless Steel Pan – 12¾"W x 20¾"D x 2½"H	138
ST PAN 4	Full-Size Stainless Steel Pan – 12¾"W x 20¾"D x 4"H	174
HDW 6" PAN	Full-Size Stainless Steel Pan – 12¾"W x 20¾"D x 6"H	187
4QT-PAN	4-Quart Round Pan	183
7QT-PAN	7-Quart Round Pan	204
11QT-PAN	11-Quart Round Pan	225
Notched Lid for Round Pans –		
4QT-LID-1	4-Quart Round, Notched Solid Lid	\$ 87
7QT-LID-1	7-Quart Round, Notched Solid Lid	106
11QT-LID-1	11-Quart Round, Notched Solid Lid	127
Hinged Lid for Round Pans –		
4QT-LID	4-Quart Round, Hinged and Notched Lid	\$114
7QT-LID	7-Quart Round, Hinged and Notched Lid	149
11QT-LID	11-Quart Round, Hinged and Notched Lid	186
Wire Trivets Stainless –		
TRIVET (1/2)SS	Half-Size – 10⅜"W x 7⅞"D	\$186
TRIVET SS	Full-Size – 10⅞"W x 18"D	259

HDW 6" PAN

11QT-PAN



ADAPTERS, SUPPORT BARS, MOUNTING KITS, VALVES – PAGE 40



Individual Built-In Heated Well Accessories

(available for purchase at any time)

Heated & Cold Wells

HWB-2-7Q
shown with two
7QT-PAN and
7QT-LID-1

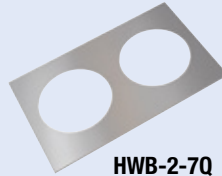

HWB-2-7Q



HWB-2-11Q



HWB-3-4Q

ADAPTERS – SUPPORT BARS

HWB-2-7Q	Adapter to convert warmer to hold two 7-Quart Inserts (HWB and HWBI Rectangular, HWBI and HWBI-S Modular Heated Wells only)	\$158
HWB-3-4Q	Adapter to convert warmer to hold three 4-Quart Inserts (HWB and HWBI Rectangular, HWBI and HWBI-S Modular Heated Wells only)	158
HWB-2-11Q	Adapter to convert warmer to hold two 11-Quart Inserts (HWB-43 Rectangular and HWBI43 Modular Heated Wells only)	198
HWB12BAR	12" Pan Support Bar for Built-In and Drop-In Heated Wells	34
HWB20BAR	20" Pan Support Bar for Built-In and Drop-In Heated Wells	40
HWBGM12BAR	12" Pan Support Bar for Drop-In Modular/Ganged Models	34
HWBGM20BAR	20" Pan Support Bar for Drop-In Modular/Ganged Models	40

Support Bars
Choose the appropriate kit for HWBI or HWB series

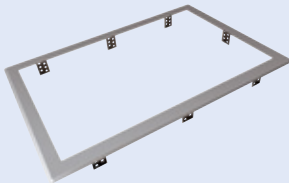

HWB-FUL-MNT
Choose the appropriate kit for HWB-FUL, HWB-43 or HWB-4Q, -7Q, -11Q series

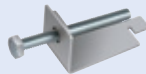

HWB-MNT-REC or
HWB-MNT-RND



HWBI2MANIF



BALLVALVE1INCH

MOUNTING KITS – VALVES

Necessary at your Well installation –

HWB-FUL-MNT	Mounting Kit for combustible countertops for HWB-FUL series only	\$202
HWB-43-MNT	Mounting Kit for combustible countertops for HWB-43 series only	244
HWB-4Q-MNT	Mounting Kit for combustible countertops for HWB-4Q series only	121
HWB-7Q-MNT	Mounting Kit for combustible countertops for HWB-7Q series only	132
HWB-11Q-MNT	Mounting Kit for combustible countertops for HWB-11Q series only	143

HWB-MNT-REC	Kit allows mounting to thick countertops - 8 Brackets (HWBI and HWB Rectangular Heated Wells, HWBI Modular Heated Wells only)	145
HWB-MNT-RND	Kit allows mounting to thick countertops - 4 Brackets (Round Heated Wells only)	73

External Manifold includes Individual Ball Valve for each Well (HWBI only, not available for the Slim models) –

HWBI2MANIF	2-Pan Accessory	\$1500
HWBI3MANIF	3-Pan Accessory	2128
HWBI4MANIF	4-Pan Accessory	2758
HWBI5MANIF	5-Pan Accessory	3386
HWBI6MANIF	6-Pan Accessory	4015

Necessary at your Well Installation –

BALLVALVE3/4	High Temperature 3/4" NPT Ball Valve for units with Individual Drain(s) and no Manifold	\$189
BALLVALVE1INCH	High Temperature 1" NPT Ball Valve for units with Manifold Drain (Ganged Heated Wells only)	145
GATEVALVE3/4IN	High Temperature 3/4" NPT Gate Valve for units with Individual Drain(s) and no Manifold	218
GATEVALVE1INCH	High Temperature 1" NPT Gate Valve for units with Manifold Drain (Ganged Heated Wells only)	322
HWB-RDHV	Heated Well Remote Handle for 3/4" Drains only and includes a Ball Valve	747



GATEVALVE1INCH

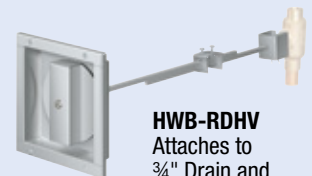

HWB-RDHV
Attaches to 3/4" Drain and includes a Ball Valve



Heated & Chilled Wells

R-290 Refrigerated Drop-In Wells Ordering Instructions

Cutaway of CWBP-6 with accessory food pans

NSF 7 Component approved cold wall construction, keeping food product cold without drying it out

A Refrigerated Well when combined with accessory support bars can house a variety of pans – full-size, half-size or third-size – showcasing a variety of your food products

The greater surface area of the angled wall and the placement of the coils allow cold air to more effectively blanket your food product

The unique top bezel design also provides easy access and clear views

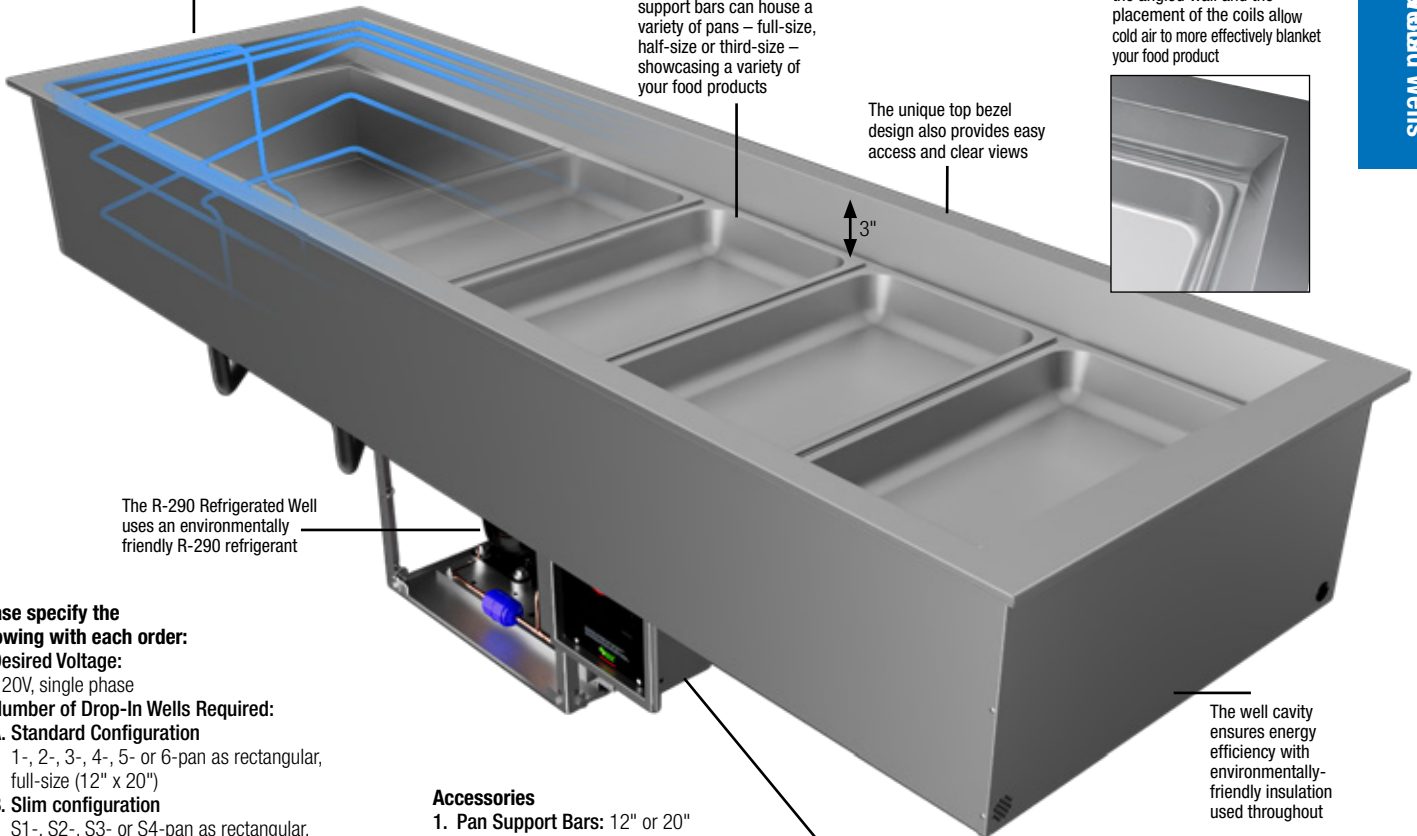
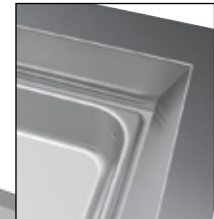

The R-290 Refrigerated Well uses an environmentally friendly R-290 refrigerant

The well cavity ensures energy efficiency with environmentally-friendly insulation used throughout

Please specify the following with each order:

1. **Desired Voltage:**
120V, single phase
2. **Number of Drop-In Wells Required:**
 - A. **Standard Configuration**
1-, 2-, 3-, 4-, 5- or 6-pan as rectangular, full-size (12" x 20")
 - B. **Slim configuration**
S1-, S2-, S3- or S4-pan as rectangular, full-size (12" x 20") but placed lengthwise
3. **Depth of Model:** Standard configuration (27"D) or Slim configuration (19"D)
4. **Agency – UL, C-UL, NSF 7 Component**
5. **Electronic Control Assembly** can be mounted on either side of the Condensing Unit or remotely mounted up to 4' from the unit (cannot be mounted over the Condensing Unit)

Options

1. Additional four year parts only warranty on the Compressor available at the time of unit purchase
2. **Slant Option** for CWBP-1, -2, -3, -4, -5, -6 or CWBP-S1, -S2, -S3, -S4
3. **Gasket Option** for CWBP-1, -2, -3, -4, -5, -6 or CWBP-S1, -S2, -S3, -S4

Accessories

1. **Pan Support Bars:** 12" or 20"
2. **Stainless Steel Pans:**
 - A. Third-size
12¾"W x 6⅞"D x 2½"H
 - B. Half-size
12¾"W x 10⅞"D x 2½"H
 - C. Full-size at 2½" deep
12¾"W x 20¼"D x 2½"H
 - D. Full-size at 4" deep
12¾"W x 20¼"D x 4"H
 - E. Full-size at 6" deep
12¾"W x 20¼"D x 6"H

Electronic control assembly can be mounted on either side of the condensing unit or remotely mounted up to 4 feet away

R-290 REFRIGERATED DROP-IN WELLS COUNTERTOP CUT-OUTS

Model	Minimum Width	Maximum Width	Minimum Depth	Maximum Depth
CWBP-1	17⅞"	18"	25⅜"	26"
CWBP-2	30⅞"	31"	25⅜"	26"
CWBP-3	43⅞"	44"	25⅜"	26"
CWBP-4	56⅞"	57"	25⅜"	26"
CWBP-5	69⅞"	70"	25⅜"	26"
CWBP-6	82⅞"	83"	25⅜"	26"
Slim Series				
CWBP-S1	25¼"	26⅛"	17⅛"	17⅝"
CWBP-S2	46¼"	47⅞"	17⅛"	17⅝"
CWBP-S3	67⅝"	68⅜"	17⅛"	17⅝"
CWBP-S4	88⅜"	89¼"	17⅛"	17⅝"

The unique angled inside wall design provides easy access and clear views. The greater surface area of the angled wall and the placement of the coils allow cold air to more effectively blanket your food product.

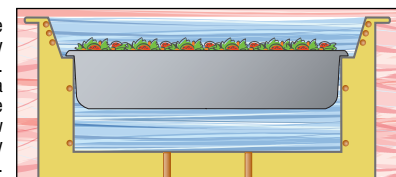



R-290 Refrigerated Drop-In Wells

Hatco's R-290 Refrigerated Drop-In Well is a full-size unit that uses an environmentally friendly R-290 refrigerant to blanket your pre-chilled food product to retain optimum freshness and taste in one efficient and easy operation – a winner for your foodservice operation.

- Full-size, insulated wells available in 1- to 6-pan configurations
- NSF 7 Component approved cold wall construction keeps food cold without drying it out
- Electronic control assembly can be mounted on either side of the condensing unit or remotely mounted up to 4 feet from the unit (cannot be mounted over the condensing unit)
- Auto-defrost is activated through an advanced electronic controller programmed at the customer location

- Condenser utilizes an environmentally friendly R-290 refrigerant, which has a 90% higher heat absorption capacity than other refrigerants, resulting in quicker temperature recovery and lower energy consumption
- Optimal insulation on sides and bottom to ensure better cold retention. Environmentally friendly insulation used throughout
- 1" brass drain simplifies cleaning



CWBP-6 with accessory food pans and pan support bars

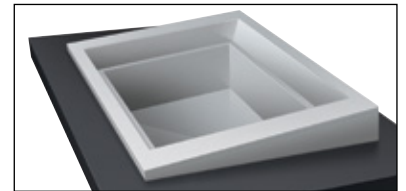

CWBP-2 with slant option CWBP-2SLANT

R-290 REFRIGERATED DROP-IN WELLS

Model	Dimensions W x D x H	Voltage	HP and Watts @ 60 Hz			Approx. Ship Weight	List Price
			HP	Watts	Plug		
CWBP-1	19" x 27" x 32 ¹ / ₁₀ "	120	1/5	345	NEMA 5-15P	127 lbs.	\$11295
CWBP-2	32" x 27" x 32 ¹ / ₁₀ "	120	1/5	345	NEMA 5-15P	150 lbs.	11941
CWBP-3	45" x 27" x 25 ¹ / ₂ "	120	1/5	345	NEMA 5-15P	173 lbs.	12716
CWBP-4	58" x 27" x 25 ¹ / ₂ "	120	1/3	440	NEMA 5-15P	211 lbs.	13836
CWBP-5	71" x 27" x 25 ¹ / ₂ "	120	1/2	560	NEMA 5-15P	245 lbs.	14627
CWBP-6	84" x 27" x 25 ¹ / ₂ "	120	1/2	560	NEMA 5-15P	292 lbs.	15953

All Refrigerated Drop-In Well Models Feature:

Voltage: Single phase.

Models Shipped with: Electronic temperature control, pan support bars for full-size pans, condensing unit, auto-defrost and filter-drier. Consult factory for refrigerant specifications.

NOTE: The installation kit, including the intake bracket, duct clamp, flexible duct, and duct collar, will be shipped separately.

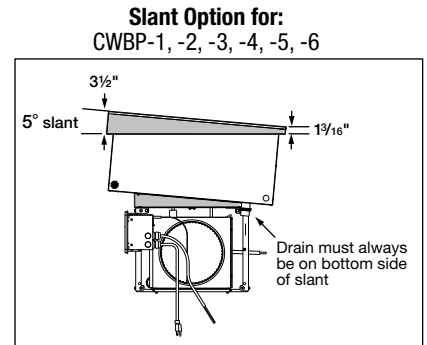

OPTIONS (available at time of purchase only)

EWC	Additional Four Year Parts Only Warranty on the Compressor	\$275
Slant Options –		
CWBP-1SLANT	Slant Option for CWBP-1	\$565
CWBP-2SLANT	Slant Option for CWBP-2	598
CWBP-3SLANT	Slant Option for CWBP-3	632
CWBP-4SLANT	Slant Option for CWBP-4	664
CWBP-5SLANT	Slant Option for CWBP-5	698
CWBP-6SLANT	Slant Option for CWBP-6	731
Gasket Options –		
BEZELGASKET-1	Factory installed for CWBP-1	\$138
BEZELGASKET-2	Factory installed for CWBP-2	138
BEZELGASKET-3	Factory installed for CWBP-3	180
BEZELGASKET-4	Factory installed for CWBP-4	180
BEZELGASKET-5	Factory installed for CWBP-5	194
BEZELGASKET-6	Factory installed for CWBP-6	194

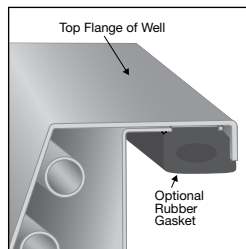

BEZELGASKET-1
Factory installed option (eliminates the need for silicone or other sealants)

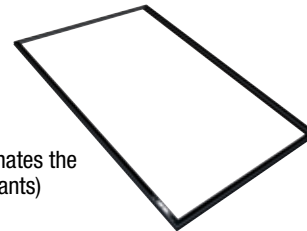

COUNTERTOP CUT-OUT DIMENSIONS – PAGE 41
ACCESSORIES – PAGE 47





R-290 Refrigerated Slim Drop-In Wells

Hatco's R-290 Refrigerated Slim Drop-In Well is a full-size unit that uses an environmentally friendly R-290 refrigerant to blanket your pre-chilled food product to retain optimum freshness and taste in one efficient and easy operation – but placed lengthwise. This provides customers with a complete cold well within easy reach.

- Insulated wells available in 1 to 4 full-size pan configurations
- NSF 7 Component approved cold wall construction keeps food product cold without drying it out
- Condenser utilizes an environmentally friendly R-290 refrigerant, which has a 90% higher heat absorption capacity than other refrigerants, resulting in quicker temperature recovery and lower energy consumption
- Auto-defrost is activated through an advanced electronic controller programmed at customer location
- Optimal insulation on sides and bottom ensure better cold retention
- 1" brass drain simplifies cleaning

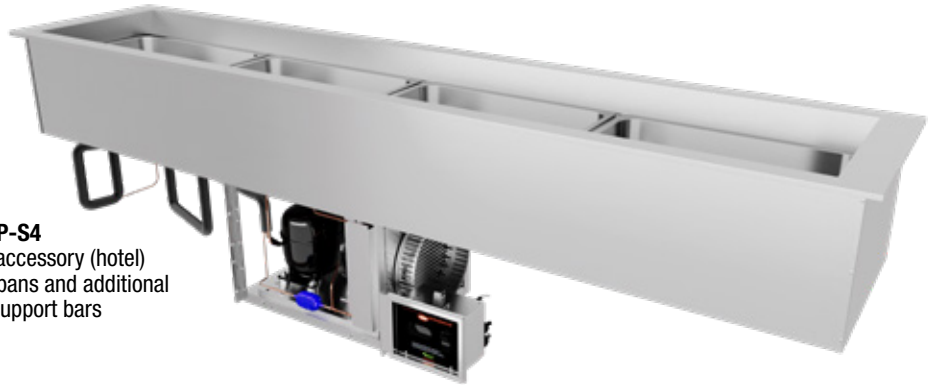

CWBP-S4
with accessory (hotel) food pans and additional pan support bars

REFRIGERATED SLIM DROP-IN WELLS

Model	Dimensions W x D x H	HP and Watts @ 60 Hz			Approx. Ship Weight	List Price
		HP	Watts	Plug		
CWBP-S1	27 ¹ / ₁₆ " x 19" x 26 ¹ / ₁₆ "	1/5	345	NEMA 5-15P	133 lbs.	\$11072
CWBP-S2	48 ¹ / ₈ " x 19" x 26 ¹ / ₁₆ "	1/5	345	NEMA 5-15P	170 lbs.	12421
CWBP-S3	69 ³ / ₁₆ " x 19" x 26 ¹ / ₁₆ "	1/3	440	NEMA 5-15P	221 lbs.	14157
CWBP-S4	90 ¹ / ₄ " x 19" x 26 ¹ / ₁₆ "	1/2	560	NEMA 5-15P	283 lbs.	15271

All Refrigerated Slim Drop-In Well Models Feature:

Voltage: 120V, single phase.

Models Shipped with: Electronic temperature control, pan support bars for full-size pans, condensing unit, auto-defrost, sight glass, and filter-drier. Consult factory for refrigerant specifications.

NOTE: The installation kit, including the intake bracket, duct clamp, flexible duct, and duct collar, will be shipped separately.

Slant Option for:
CWBP-S1, -S2, -S3, -S4

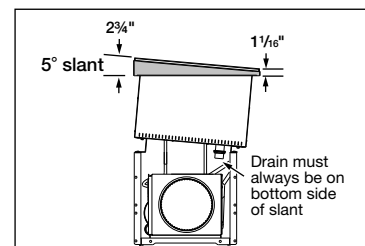

OPTIONS (available at time of purchase only)

EWC	Additional Four Year Parts Only Warranty on the Compressor	\$275
Slant Options –		
CWBP-S1SLANT	Slant Option for CWBP-S1	471
CWBP-S2SLANT	Slant Option for CWBP-S2	503
CWBP-S3SLANT	Slant Option for CWBP-S3	537
CWBP-S4SLANT	Slant Option for CWBP-S4	569
Gasket Options –		
BEZELGASKET-S1	Factory installed for CWBP-S1	\$138
BEZELGASKET-S2	Factory installed for CWBP-S2	138
BEZELGASKET-S3	Factory installed for CWBP-S3	180
BEZELGASKET-S4	Factory installed for CWBP-S4	180

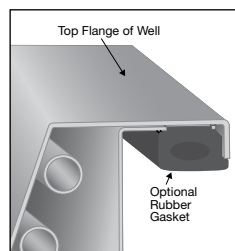

BEZELGASKET-S2
Factory installed option (eliminates the need for silicone or other sealants)

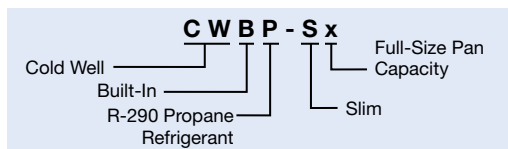

COUNTERTOP CUT-OUT DIMENSIONS – PAGE 41
ACCESSORIES – PAGE 47





Remote Refrigerated Drop-In Wells Ordering Instructions

Heated & Cold Wells

Cutaway of CWBR-6 with accessory food pans

Cold Well with: Temperature Probe

NSF 7 Component approved cold wall construction, keeping food product cold without drying it out

A Refrigerated Well can house a variety of pans – full-size, half-size or third-size – showcasing a variety of your food products

The unique top bezel design also provides easy access and clear views

The greater surface area of the angled wall and the placement of the coils allow cold air to more effectively blanket your food product

Larger brass drain ensures easy cleaning
Exclusive flat screen design ensures that pans sit flush

Auto-defrost activated through an advanced electronic controller programmed at the customer location



CWBR: with a Condensing Unit
CWBX: without a Condensing Unit

The well cavity ensures energy efficiency with environmentally-friendly insulation used throughout

Please specify the following with each order:

- Number of Drop-In Wells Required:**
 - Standard Configuration**
1-, 2-, 3-, 4-, 5- or 6-pan as rectangular, full-size (12" x 20")
 - Slim configuration**
S1-, S2-, S3- or S4-pan as rectangular, full-size (12" x 20") but placed lengthwise
- Depth of Model:** Standard configuration (27"D) or Slim configuration (19"D)
- Remote Refrigeration**
NOTE: Shipped loose: Cold Well with Temperature Probe, Control Panel (Probe Wires are 9') and a TXV Valve
 - CWBR** with a Condensing Unit – may be field mounted up to 50' of tubing from the unit (shipped loose)
 - CWBX** without a Condensing Unit (Solenoid Valve attached to Cold Well)
- Agency** – C-UL, NSF 7 Component (CWBR units C-UL only)

Option

- Additional four year parts only warranty on the Compressor available at the time of unit purchase (CWBR only)
- Slant Option** for CWBR- and CWBX-1, -2, -3, -4, -5, and -6 or -S1, -S2, -S3, -S4
- Gasket Option** for CWBR- and CWBX-1, -2, -3, -4, -5, -6 or CWBR or CWBX-S1, -S2, -S3, -S4

Accessories

- Pan Support Bars:** 12" or 20"

2. Stainless Steel Pans:

- Third-size at 2½" deep
12¾"W x 6⅞"D x 2½"H
- Half-size at 2½" deep
12¾"W x 10⅞"D x 2½"H
- Full-size at 2½" deep
12¾"W x 20¾"D x 2½"H
- Full-size at 4" deep
12¾"W x 20¾"D x 4"H
- Full-size at 6" deep
12¾"W x 20¾"D x 6"H

3. Perforated False Bottom

4. Trivets:

- Half-size
10⅞"W x 7⅞"D
- Full-size
10⅞"W x 18"D

ACCESSORIES – PAGE 47

REMOTE REFRIGERATED DROP-IN WELLS COUNTERTOP CUT-OUTS

Model	Minimum Width	Maximum Width	Minimum Depth	Maximum Depth
CWBR-1, CWBX-1	17⅞"	18"	25⅞"	26"
CWBR-2, CWBX-2	30⅞"	31"	25⅞"	26"
CWBR-3, CWBX-3	43⅞"	44"	25⅞"	26"
CWBR-4, CWBX-4	56⅞"	57"	25⅞"	26"
CWBR-5, CWBX-5	69⅞"	70"	25⅞"	26"
CWBR-6, CWBX-6	82⅞"	83"	25⅞"	26"
Slim Series				
CWBR-S1, CWBX-S1	25¼"	26⅞"	17⅞"	18"
CWBR-S2, CWBX-S2	46¼"	47⅞"	17⅞"	18"
CWBR-S3, CWBX-S3	67⅞"	68⅞"	17⅞"	18"
CWBR-S4, CWBX-S4	88⅞"	89¼"	17⅞"	18"





Remote Refrigerated Drop-In Wells

Hatco's Remote Refrigerated Drop-In Wells keep pre-chilled food products at safe-serving temperatures but in a remote configuration that offers unlimited flexibility for your own particular dining design needs.

- Full-size, insulated wells available in 1- to 6-pan configurations
- NSF 7 Component approved cold wall construction keeps food cold without drying it out
- Optimal insulation on sides and bottom to ensure better cold retention. Environmentally-friendly insulation used throughout
- CWBR models include a condensing unit (shipped loose, can be field mounted up to 50 feet of tubing from unit) and control panel (shipped loose - probe wires are 9 feet) for installing in more convenient or desirable locations

- CWBX model include a control panel (shipped loose - probe wires are 9 feet) but without a condensing unit for the increased flexibility of multiple cold well configurations
- Easy serviceability with a sight glass, service valves, dryer and a receiver (CWBR models only)
- Auto-defrost is activated through an advanced electronic controller programmed at the customer location
- 1" NPT (National Pipe Thread) brass drain simplifies cleaning



CWBR-6 with accessory food pans and pan support bars



CWBX-6 with accessory food pans and pan support bars

Control panel and a condensing unit (shipped loose)

Control panel (shipped loose)

REMOTE REFRIGERATED DROP-IN FULL-SIZE WELLS – WITH CONDENSING UNIT AND REMOTE CONTROL PANEL

Model	Dimensions W x D x H	HP	Hz	Approx. Ship Weight	List Price
CWBR-1	19" x 27" x 12"	1/8	60	131 lbs.	\$10237
CWBR-2	32" x 27" x 12"	1/8	60	160 lbs.	10970
CWBR-3	45" x 27" x 12"	1/8	60	213 lbs.	11844
CWBR-4	58" x 27" x 12"	1/8	60	200 lbs.	12774
CWBR-5	71" x 27" x 12"	3/8	60	271 lbs.	13937
CWBR-6	84" x 27" x 12"	3/8	60	313 lbs.	14853

All Remote Refrigerated Drop-In Well Models with Condensing Unit and Remote Control Panel Feature:

Voltage: CWBR-1, -2, -3: 120V, 300 watts, single phase.
 CWBR-4: 120V, 450 watts, single phase.
 CWBR-5, -6: 120V, 800 watts, single phase.

Models Shipped with: Electronic temperature control, condensing unit and TXV valve (all shipped loose). Consult factory for refrigerant specifications.

REMOTE REFRIGERATED DROP-IN FULL-SIZE WELLS – WITH REMOTE CONTROL PANEL

Model	Dimensions W x D x H	BTU/ Hour	Hz	Approx. Ship Weight	List Price
CWBX-1	19" x 27" x 17 1/16"	330	60	94 lbs.	\$ 8226
CWBX-2	32" x 27" x 17 1/16"	630	60	123 lbs.	8959
CWBX-3	45" x 27" x 17 1/16"	930	60	150 lbs.	9833
CWBX-4	58" x 27" x 17 1/16"	1230	60	176 lbs.	10763
CWBX-5	71" x 27" x 17 1/16"	1530	60	211 lbs.	11926
CWBX-6	84" x 27" x 17 1/16"	1830	60	250 lbs.	12842

All Remote Refrigerated Drop-In Well Models with Remote Control Panel Feature:

Voltage: 120V, single phase.
 Models Shipped with: Electronic temperature control, TXV valve (shipped loose) and a solenoid valve attached to well.

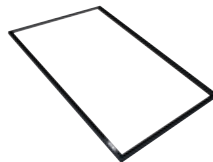

BEZELGASKET-1

Factory installed option (eliminates the need for silicone or other sealants)

OPTIONS (available at time of purchase only)

EWC	Additional Four Year Parts Only Warranty on the Compressor (CWBR only)	\$275
Slant Options –		
CWBR-1SLANT	Slant Option for CWBR-1, CWBX-1	\$426
CWBR-2SLANT	Slant Option for CWBR-2, CWBX-2	459
CWBR-3SLANT	Slant Option for CWBR-3, CWBX-3	493
CWBR-4SLANT	Slant Option for CWBR-4, CWBX-4	525
CWBR-5SLANT	Slant Option for CWBR-5, CWBX-5	559
CWBR-6SLANT	Slant Option for CWBR-6, CWBX-6	592

Gasket Options –

BEZELGASKET-1	Factory installed for CWBR-1, CWBX-1	\$137
BEZELGASKET-2	Factory installed for CWBR-2, CWBX-2	137
BEZELGASKET-3	Factory installed for CWBR-3, CWBX-3	180
BEZELGASKET-4	Factory installed for CWBR-4, CWBX-4	180
BEZELGASKET-5	Factory installed for CWBR-5, CWBX-5	194
BEZELGASKET-6	Factory installed for CWBR-6, CWBX-6	194

COUNTERTOP CUT-OUT DIMENSIONS – PAGE 44 ACCESSORIES – PAGE 47

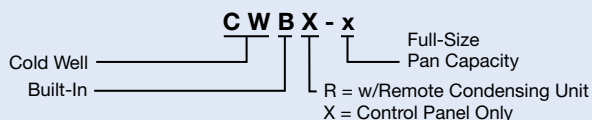



Remote Refrigerated Slim Drop-In Wells

Hatco's Remote Refrigerated Slim Drop-In Well is a full-size unit that blankets your pre-chilled food product to retain optimum freshness and taste in one efficient and easy operation – but placed lengthwise and in two remote configurations. This provides customers with a complete cold well within easy reach, and unlimited flexibility for your design needs.

- Full-size, Insulated wells available in 1 to 4 full-size pan configurations
- NSF 7 Component approved cold wall construction keeps food product cold without drying it out
- Optimal insulation on sides and bottom to ensure better cold retention. Environmentally-friendly insulation used throughout
- CWBR-S models include a condensing unit (shipped loose, can be field mounted up to 50 feet of tubing from unit) and control panel (shipped loose - probe wires are 9 feet) for installing in more convenient or desirable locations
- CWBX-S model include a control panel (shipped loose - probe wires are 9 feet) but without a condensing unit for the increased flexibility of multiple cold well configurations
- Easy serviceability with a sight glass, service valves, dryer and a receiver (CWBR-S models only)
- Auto-defrost is activated through an advanced electronic controller programmed at customer location
- Optimal insulation on sides and bottom ensure better cold retention
- 1" NPT (National Pipe Thread) brass drain simplifies cleaning

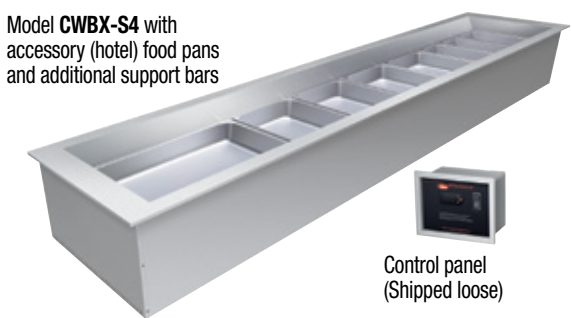

REMOTE REFRIGERATED SLIM DROP-IN FULL-SIZE WELLS – WITH CONDENSING UNIT AND REMOTE CONTROL PANEL

Model	Dimensions W x D x H	HP	Watts	Approx. Ship Weight	List Price
CWBR-S1	27 ¹ / ₁₆ " x 19" x 12"	1/2	300	131 lbs.	\$10237
CWBR-S2	48 ¹ / ₈ " x 19" x 12"	1/2	300	162 lbs.	11321
CWBR-S3	69 ³ / ₁₆ " x 19" x 12"	1/2	450	213 lbs.	13223
CWBR-S4	90 ¹ / ₄ " x 19" x 12"	5/8	800	235 lbs.	16131

REMOTE REFRIGERATED SLIM DROP-IN FULL-SIZE WELLS – WITH REMOTE CONTROL PANEL

Model	Dimensions W x D x H	Load/ BTU/H	Hz	Approx. Ship Weight	List Price
CWBX-S1	27 ¹ / ₁₆ " x 19" x 17 ¹ / ₈ "	330	60	94 lbs.	\$ 8226
CWBX-S2	48 ¹ / ₈ " x 19" x 17 ¹ / ₈ "	630	60	123 lbs.	9310
CWBX-S3	69 ³ / ₁₆ " x 19" x 17 ¹ / ₈ "	930	60	150 lbs.	11212
CWBX-S4	90 ¹ / ₄ " x 19" x 17 ¹ / ₈ "	1230	60	221 lbs.	14120

All Remote Refrigerated Slim Drop-In Well Models with Condensing Unit and Remote Control Panel Feature:
Voltage: 120V, single phase.
Models Shipped with: Electronic temperature control, condensing unit and TXV valve (all shipped loose). Consult factory for refrigerant specifications.

All Remote Refrigerated Slim Drop-In Well Models with Remote Control Panel Feature:
Voltage: 120V, single phase.
Models Shipped with: Electronic temperature control, TXV valve (all shipped loose) and a solenoid valve attached to the well.

OPTIONS (available at time of purchase only)

EWC	Additional Four Year Parts Only Warranty on the Compressor	\$275
Slant Options –		
CWB-S1SLANT	Slant Option for CWBR-S1 and CWBX-S1	\$471
CWB-S2SLANT	Slant Option for CWBR-S2 and CWBX-S2	503
CWB-S3SLANT	Slant Option for CWBR-S3 and CWBX-S3	537
CWB-S4SLANT	Slant Option for CWBR-S4 and CWBX-S4	567

Gasket Options –		
BEZELGASKET-S1	Factory installed for CWBR-S1 and CWBX-S1	\$137
BEZELGASKET-S2	Factory installed for CWBR-S2 and CWBX-S2	137
BEZELGASKET-S3	Factory installed for CWBR-S3 and CWBX-S3	180
BEZELGASKET-S4	Factory installed for CWBR-S4 and CWBX-S4	180

COUNTERTOP CUT-OUT DIMENSIONS – PAGE 44 ACCESSORIES – PAGE 47

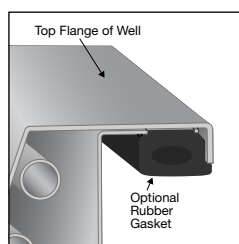
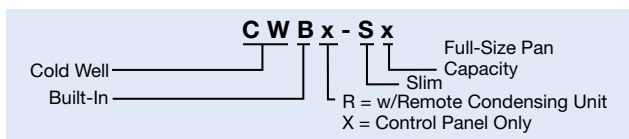

BEZELGASKET-S1
 Factory installed option (eliminates the need for silicone or other sealants)



Refrigerated Drop-In Well Accessories (available for purchase at any time)



CWB-2 with optional CWB-2SLANT, and accessory food pans and pan support bars

Heated & Cold Wells

PANS – TRIVETS (available for purchase at any time)

ST PAN 1/3	Third-Size Stainless Steel Pan – 12 $\frac{3}{4}$ "W x 6 $\frac{7}{8}$ "D x 2 $\frac{1}{2}$ "H	\$101
ST PAN 1/2	Half-Size Stainless Steel Pan – 12 $\frac{3}{4}$ "W x 10 $\frac{3}{8}$ "D x 2 $\frac{1}{2}$ "H	116
ST PAN 2	Full-Size Stainless Steel Pan – 12 $\frac{3}{4}$ "W x 20 $\frac{3}{4}$ "D x 2 $\frac{1}{2}$ "H	138
ST PAN 4	Full-Size Stainless Steel Pan – 12 $\frac{3}{4}$ "W x 20 $\frac{3}{4}$ "D x 4"H	174
HDW 6" PAN	Full-Size Stainless Steel Pan – 12 $\frac{3}{4}$ "W x 20 $\frac{3}{4}$ "D x 6"H	187
Wire Trivets Stainless –		
TRIVET (1/2)SS	Half-Size – 10 $\frac{1}{16}$ "W x 7 $\frac{7}{8}$ "D	\$186
TRIVET SS	Full-Size – 10 $\frac{1}{8}$ "W x 18"D	259

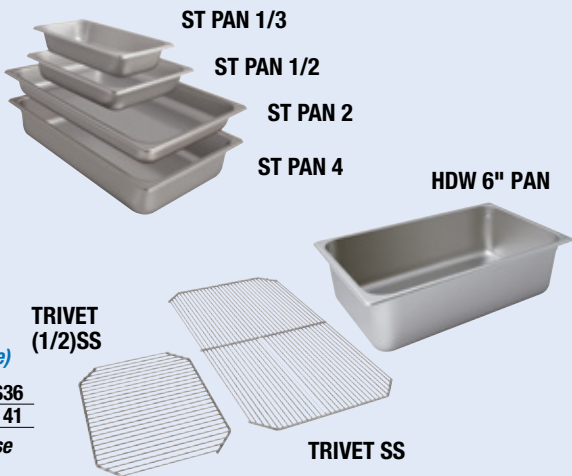

SUPPORT BARS – FALSE BOTTOMS (available for purchase at any time)

CWB12BAR	12" Pan Support Bar for Drop-In Ice Refrigerated Wells	\$36
CWB20BAR	20" Pan Support Bar for Drop-In Ice Refrigerated Wells	41
False Bottom for Drop-In Refrigerated Wells (Perforated False Bottom Accessory, choose your appropriate pan size) –		
CWB-1FB	For CWB-1 Series (1-Part Accessory)	\$161
CWB-2FB	For CWB-2 Series (1-Part Accessory)	295
CWB-3FB	For CWB-3 Series (2-Part Accessory)	427
CWB-4FB	For CWB-4 Series (2-Part Accessory)	561
CWB-5FB	For CWB-5 Series (3-Part Accessory)	694
CWB-6FB	For CWB-6 Series (3-Part Accessory)	826
False Bottom for Slim Refrigerated Wells (choose your appropriate pan size) –		
1FBS8	For CWB-S1 Series (1-Part Accessory)	\$161
2FBS8	For CWB-S2 Series (1-Part Accessory)	295
3FBS8	For CWB-S3 Series (2-Part Accessory)	427
4FBS8	For CWB-S4 Series (2-Part Accessory)	561

Support Bars
Choose the appropriate kit for CWB or IWB series

False Bottom Accessories
1-part, 2- or 3-part(s) depending on pan size

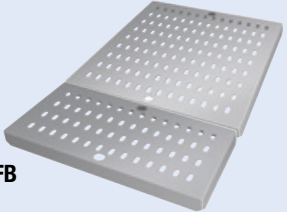

CWB-3FB

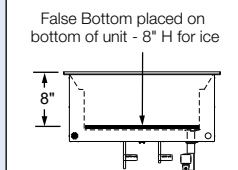

(CWB-1, -2, -3, -4, -5 or -6FB) for the CWB series

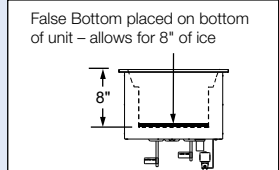

(1, 2, 3, or 4FBS8) for the CWB-S series



Drop-In Ice Wells

Hatco Drop-In Ice Wells provide all the quality features of our Refrigerated Drop-Ins, but without any refrigeration or electrical components. These ice-cooled, insulated units can hold pre-chilled food products at preferred serving temperatures. Ideal for salad bars, cold buffets and chilled beverage bars. Pan dividers give you greater flexibility in your variety of featured food products.

- Full-size, insulated, top mount wells available to hold 1- to 6-pan configurations
- Optimal insulation on sides and bottom to ensure better cold retention and cost savings
- Bezel design allows clear viewing and easy food access
- Larger 1" NPT (National Pipe Thread) brass drain with flat screen simplifies cleaning
- False bottom accessory conveniently holds ice above drain for ease of draining
- Matches the Hatco line of Wells for a fully integrated look

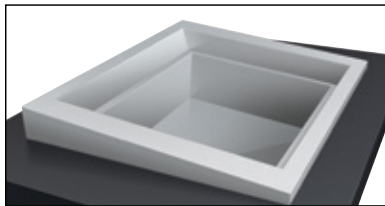

IWB-2 with slant option IWB-2SLANT



IWB-6 with an accessory food pan (bowls not available) and an optional gasket

DROP-IN INSULATED ICE WELLS

Model	Dimensions W x D x H	Approx. Ship Weight	List Price
IWB-1	19" x 27" x 12"	62 lbs.	\$2917
IWB-2	32" x 27" x 12"	83 lbs.	3361
IWB-3	45" x 27" x 12"	102 lbs.	3893
IWB-4	58" x 27" x 12"	144 lbs.	4512
IWB-5	71" x 27" x 12"	110 lbs.	5223
IWB-6	84" x 27" x 12"	180 lbs.	6023

OPTIONS (available at time of purchase only)

Slant Options –		
IWB-1SLANT	Slant Option for IWB-1	\$426
IWB-2SLANT	Slant Option for IWB-2	459
IWB-3SLANT	Slant Option for IWB-3	493
IWB-4SLANT	Slant Option for IWB-4	525
IWB-5SLANT	Slant Option for IWB-5	559
IWB-6SLANT	Slant Option for IWB-6	592

Gasket Options –		
BEZELGASKET-1	Factory installed for IWB-1	\$137
BEZELGASKET-2	Factory installed for IWB-2	137
BEZELGASKET-3	Factory installed for IWB-3	180
BEZELGASKET-4	Factory installed for IWB-4	180
BEZELGASKET-5	Factory installed for IWB-5	194
BEZELGASKET-6	Factory installed for IWB-6	194

ACCESSORIES – PAGE 50

DROP-IN ICE WELL COUNTERTOP CUT-OUTS

Model	Minimum Width	Maximum Width	Minimum Depth	Maximum Depth
IWB-1	17 ⁷ / ₈ "	18"	25 ³ / ₁₆ "	26"
IWB-2	30 ⁷ / ₈ "	31"	25 ³ / ₁₆ "	26"
IWB-3	43 ⁷ / ₈ "	44"	25 ³ / ₁₆ "	26"
IWB-4	56 ⁷ / ₈ "	57"	25 ³ / ₁₆ "	26"
IWB-5	69 ⁷ / ₈ "	70"	25 ³ / ₁₆ "	26"
IWB-6	82 ⁷ / ₈ "	83"	25 ³ / ₁₆ "	26"

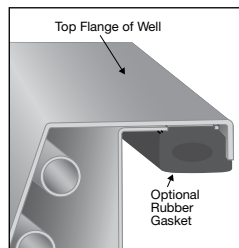
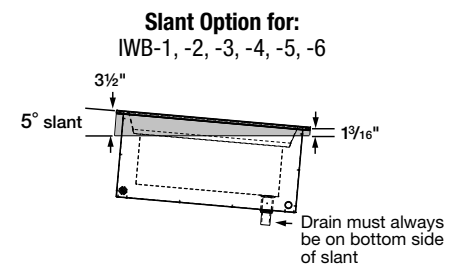

BEZELGASKET-1
Factory installed option (eliminates the need for silicone or other sealants)

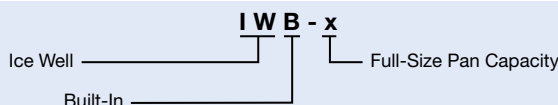
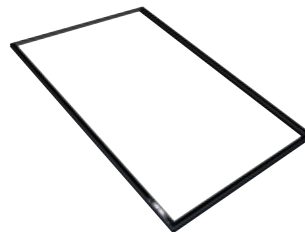



Drop-In Slim Ice Wells

Hatco Drop-In Slim Ice Wells provide all the quality features of our Refrigerated Drop-Ins, but without any refrigeration or electrical components. Now available in a slim configuration providing customers with a complete well within easy reach.

Ideal for salad bars, cold buffets and chilled beverage bars. Pan dividers give you greater flexibility in your variety of featured food products.

- Holds 1- to 4-full-size pan configurations, but placed lengthwise
- Optimal insulation on sides and bottom to ensure better cold retention and cost savings
- Bezel design allows clear viewing and easy food access

- Larger 1" NPT (National Pipe Thread) brass drain with flat screen simplifies cleaning
- False bottom accessory conveniently holds ice above drain for ease of draining



IWB-S4
with optional
IWB-S4SLANT



IWB-S2

DROP-IN INSULATED SLIM ICE WELLS

Model	Dimensions W x D x H	Approx. Ship Weight	List Price
IWB-S1	27 ¹ / ₁₆ " x 19" x 12"	58 lbs.	\$3029
IWB-S2	48 ¹ / ₈ " x 19" x 12"	105 lbs.	3472
IWB-S3	69 ³ / ₁₆ " x 19" x 12"	145 lbs.	4004
IWB-S4	90 ¹ / ₄ " x 19" x 12"	202 lbs.	4624

OPTIONS (available at time of purchase only)

Slant Options –

IWB-S1SLANT	Slant Option for IWB-S1	\$426
IWB-S2SLANT	Slant Option for IWB-S2	459
IWB-S3SLANT	Slant Option for IWB-S3	493
IWB-S4SLANT	Slant Option for IWB-S4	525

Gasket Options –

BEZELGASKET-S1	Factory installed for IWB-S1	\$137
BEZELGASKET-S2	Factory installed for IWB-S2	137
BEZELGASKET-S3	Factory installed for IWB-S3	180
BEZELGASKET-S4	Factory installed for IWB-S4	180

ACCESSORIES – PAGE 50

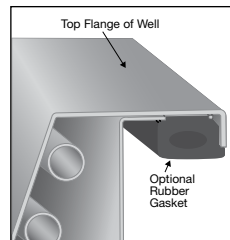
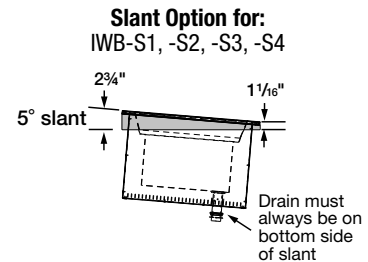

BEZELGASKET-S1
Factory installed option (eliminates the need for silicone or other sealants)

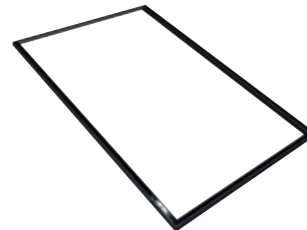

DROP-IN SLIM ICE WELLS COUNTERTOP CUT-OUTS

Model	Minimum Width	Maximum Width	Minimum Depth	Maximum Depth
IWB-S1	25 ¹ / ₄ "	26 ¹ / ₁₆ "	17 ¹ / ₁₆ "	17 ¹⁵ / ₁₆ "
IWB-S2	46 ¹ / ₄ "	47 ¹ / ₈ "	17 ¹ / ₁₆ "	17 ¹⁵ / ₁₆ "
IWB-S3	67 ⁷ / ₁₆ "	68 ³ / ₁₆ "	17 ¹ / ₁₆ "	17 ¹⁵ / ₁₆ "
IWB-S4	88 ³ / ₈ "	89 ¹ / ₄ "	17 ¹ / ₁₆ "	17 ¹⁵ / ₁₆ "

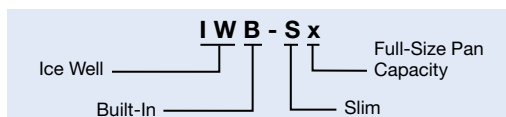



Drop-In Ice Well Accessories (available for purchase at any time)



IWB-6
with accessory food pan
(bowls not available)

PANS – TRIVETS (available for purchase at any time)

ST PAN 1/3	Third-Size Stainless Steel Pan – 12 $\frac{3}{4}$ "W x 6 $\frac{7}{8}$ "D x 2 $\frac{1}{2}$ "H	\$101
ST PAN 1/2	Half-Size Stainless Steel Pan – 12 $\frac{3}{4}$ "W x 10 $\frac{3}{8}$ "D x 2 $\frac{1}{2}$ "H	116
ST PAN 2	Full-Size Stainless Steel Pan – 12 $\frac{3}{4}$ "W x 20 $\frac{3}{4}$ "D x 2 $\frac{1}{2}$ "H	138
ST PAN 4	Full-Size Stainless Steel Pan – 12 $\frac{3}{4}$ "W x 20 $\frac{3}{4}$ "D x 4"H	174
HDW 6" PAN	Full-Size Stainless Steel Pan – 12 $\frac{3}{4}$ "W x 20 $\frac{3}{4}$ "D x 6"H	187
Wire Trivets Stainless –		
TRIVET (1/2)SS	Half-Size – 10 $\frac{3}{16}$ "W x 7 $\frac{5}{8}$ "D	\$186
TRIVET SS	Full-Size – 10 $\frac{1}{8}$ "W x 18"D	259

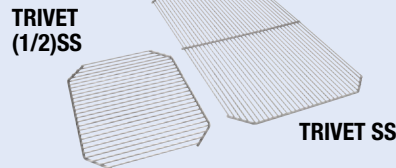

SUPPORT BARS – FALSE BOTTOMS (available for purchase at any time)

Bars –		
CWB12BAR	12" Pan Support Bar for Drop-In Ice or Refrigerated Wells	\$36
CWB20BAR	20" Pan Support Bar for Drop-In Ice or Refrigerated Wells	41

False Bottoms for Ice Wells (allows for 3$\frac{1}{2}$" of ice and sits on ledge of well) –		
1FB3.5	For IWB-1 models (includes one 1-pan Insert)	\$161
2FB3.5	For IWB-2 models (includes one 2-pan Insert)	295
3FB3.5	For IWB-3 models (includes one 1-pan Insert and one 2-pan Insert)	427
4FB3.5	For IWB-4 models (includes two 2-pan Insert)	561
5FB3.5	For IWB-5 models (includes one 1-pan Insert and two 2-pan Inserts)	694
6FB3.5	For IWB-6 models (includes three 2-pan Inserts)	826

False Bottoms for Slim Ice Wells (allows for 3$\frac{1}{2}$" of ice and sits on ledge of well) –		
1FBS3.5	For IWB-S1 models (includes one 1-pan Insert)	\$161
2FBS3.5	For IWB-S2 models (includes one 2-pan Insert)	295
3FBS3.5	For IWB-S3 models (includes one 1-pan Insert and one 2-pan Insert)	427
4FBS3.5	For IWB-S4 models (includes two 2-pan Inserts)	561

False Bottoms for Ice Wells (allows for 8" of ice and sits on bottom of well) –		
1FB8	For IWB-1 models (includes one 1-pan Insert)	\$161
2FB8	For IWB-2 models (includes one 2-pan Insert)	295
3FB8	For IWB-3 models (includes one 1-pan Insert and one 2-pan Insert)	427
4FB8	For IWB-4 models (includes two 2-pan Insert)	561
5FB8	For IWB-5 models (includes one 1-pan Insert and two 2-pan Inserts)	694
6FB8	For IWB-6 models (includes three 2-pan Inserts)	826

False Bottoms for Slim Ice Wells (allows for 8" of ice and sits on bottom of well) –		
1FBS8	For IWB-S1 models (includes one 1-pan Insert)	\$161
2FBS8	For IWB-S2 models (includes one 2-pan Insert)	295
3FBS8	For IWB-S3 models (includes one 1-pan Insert and one 2-pan Insert)	427
4FBS8	For IWB-S4 models (includes two 2-pan Inserts)	561

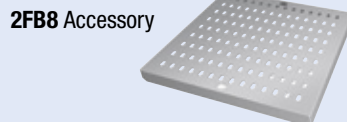

False Bottom Accessories

1-part, 2-part or 3-part(s) depending on pan size

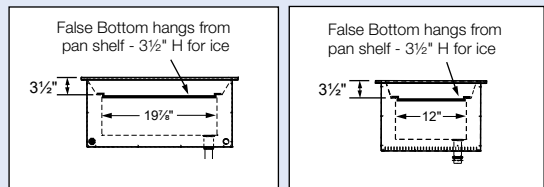

(1, 2, 3, 4, 5 or 6FB3.5) for the IWB Series

(1, 2, 3 or 4FBS3.5) for the IWB-S Series

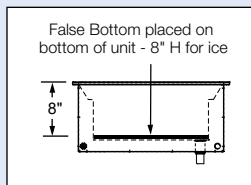
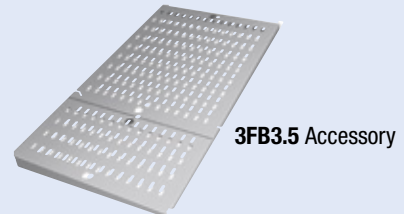

(1, 2, 3, 4, 5 or 6FB8) for the IWB Series

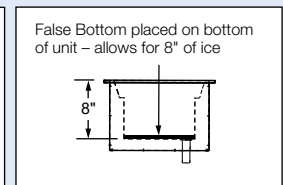

(1, 2, 3 or 4FBS8) for the IWB-S Series

Heated & Cold Shelves





Glo-Ray® Portable Round Heated Shelves

The contemporary-styled Round Heated Shelves keeps hot food at serving temperatures. Ideal when used for wrapped product or for use behind a sneeze guard with unwrapped food like pizza, biscuits, muffins and cookies.

- Unit is designed for countertop or built-in use – see cutout dimensions shown below
- Uniform heat distribution with blanket-type element
- Thermostatically-controlled heated base
- Available in three sizes to hold standard 15", 17" or 19" diameter pans
- Optional stainless steel trim



GRSR-17 in optional Designer Navy Blue with Accessory food pan

GRSR-19 in optional Designer Hunter Green with Accessory pizza pan

GLO-RAY PORTABLE ROUND HEATED SHELVES

Model	Dimensions Diameter x H	Max. Pan Size Diameter	Voltage Single Phase	Watts	Plug	Approx. Ship Weight	List Price
GRSR-15	16¾" x 3⅞"	15"	120	250	NEMA 5-15P	12 lbs.	\$1594
GRSR-17	18¾" x 3⅞"	17"	120	325	NEMA 5-15P	14 lbs.	1678
GRSR-19	20¾" x 3⅞"	19"	120	400	NEMA 5-15P	17 lbs.	1778

All Glo-Ray Portable Round Heated Shelf Models Feature:
Cord Location: 6' cord and plug, located underneath.

ACCESSORIES – PAGE 54

OPTIONS (available at time of purchase only)

Designer Colors – Non-standard colors are non-returnable – Black standard –

RED	Warm Red	No Charge
GRAY	Gray Granite	No Charge
WHITE	White Granite	No Charge
NAVY	Navy Blue	No Charge
GREEN	Hunter Green	No Charge
COPPER	Antique Copper	No Charge
SS SIDE	Stainless Steel Side	No Charge

FOOD PANS AND TRIVETS – PAGE 240

COLORS AND FINISHES – PAGE 241

PORTABLE ROUND HEATED SHELVES COUNTERTOP CUTOUT DIMENSIONS (For Built-in Applications)

Model	Minimum Diameter	Maximum Diameter	Below Counter
GRSR-15	16⅞"	16¼"	5⅝"
GRSR-17	18⅞"	18¼"	5⅝"
GRSR-19	20⅞"	20¼"	5⅝"

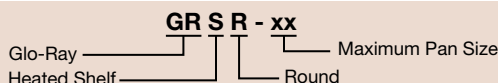



Glo-Ray® Portable Heated Simulated Stone Shelves

Hatco's Glo-Ray® Simulated Stone Round Portable Heated Shelves are made of foodsafe materials and are offered in three colors. These unique warmers will safely hold food hot while blending in with your décor and are ideal for buffet lines or as hors d'oeuvre displays.

- Blanket-type element creates uniform heat across the entire simulated stone surface
- Features a lighted rocker switch and thermostatically-controlled heated base to help hold your food hot and delicious
- Optional 3" or 5" risers available in stainless steel (Standard) or Designer Colors
- Models with simulated stone are Swanstone®

GRSSR-16 in Standard Night Sky simulated stone with optional 3" riser in optional Designer Gray Granite



GRSSR-20 in Standard Night Sky simulated stone



GRSSR20-DL77516 in Standard Night Sky simulated stone with Standard Designer Black Base and Lamp



GLO-RAY PORTABLE ROUND HEATED SIMULATED STONE SHELVES

Model	Dimensions Dia. x H	Voltage Single Phase	Watts	Amps	Plug	Approx. Ship Weight	List Price
GRSSR-16	16" x 2½"	120	250	2.1	NEMA 5-15P	14 lbs.	\$2051
GRSSR-18	18" x 2½"	120	325	2.7	NEMA 5-15P	16 lbs.	2187
GRSSR-20	20" x 2½"	120	400	3.3	NEMA 5-15P	18 lbs.	2324

All Glo-Ray Portable Round Heated Simulated Stone Shelf Models Feature:

Temperature Range: 100°-200°F.

Cord Location: 6' cord and plug, located on back side on base.

GLO-RAY PORTABLE ROUND HEATED SIMULATED STONE SHELVES with DECORATIVE LAMP

Model	Dimensions W x D x H	Voltage Single Phase	Watts	Amps	Plug	Approx. Ship Weight	List Price
GRSSR16-DL77516	16" x 20½" x 36"	120	500	4.2	NEMA 5-15P	27 lbs.	\$2905
GRSSR18-DL77516	18" x 21½" x 36"	120	575	4.8	NEMA 5-15P	30 lbs.	3039
GRSSR20-DL77516	20" x 22½" x 36"	120	650	5.4	NEMA 5-15P	32 lbs.	3172

All Glo-Ray Portable Round Heated Simulated Stone Shelf Models with Decorative Lamp Feature:

Bulb: One, 250 Watt clear bulb, uncoated.

Temperature Range: 100°-200°F.

Cord Location: 6' cord and plug, located on back side on base.

Lamp Distance: 16¼" space from bottom of shade to base.

OPTIONS AND ACCESSORIES – PAGE 54

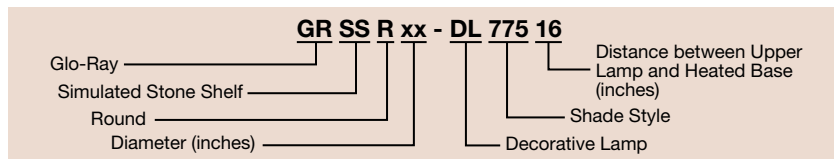
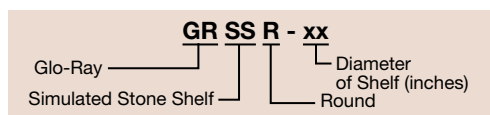



Two GRSSR20-DL77516 units in optional Gray Granite simulated stone and Standard Designer Black Base and Shade

OPTIONS (available at time of purchase only)

120H-CTD-W	120V, 375W Clear Coated Bulb in lieu of 120V uncoated white bulb (High Watt models only)	\$96
120H-UCTD-W	120V, 375W Clear Uncoated Bulb in lieu of 120V uncoated white bulb (High Watt models only)	74

Designer Color Base (and Lamp for GRSSRxx-DL77516 models) – Non-standard colors are non-returnable – Black standard –

RED	Warm Red	No Charge
GRAY	Gray Granite	No Charge
WHITE	White Granite	No Charge
NAVY	Navy Blue	No Charge
GREEN	Hunter Green	No Charge
COPPER	Antique Copper	No Charge

Simulated stone color – Non-standard colors are non-returnable – Night Sky standard –

SS-GGRAN	Gray Granite	No Charge
SS-BSAND	Bermuda Sand	No Charge

3" Risers (not available on the GRSSRxx-DL77516 models) – Available in Designer Colors– Non-standard colors are non-returnable – Stainless Steel standard –

3RISER16	GRSSR-16	\$103
3RISER18	GRSSR-18	103
3RISER20	GRSSR-20	103

5" Risers (not available on the GRSSRxx-DL77516 models) – Available in Designer Colors – Non-standard colors are non-returnable – Stainless Steel standard –

5RISER16	GRSSR-16	\$134
5RISER18	GRSSR-18	134
5RISER20	GRSSR-20	134

ACCESSORIES (available for purchase at any time)

WHITE-CTD-120	250 Watt Clear Bulb, Coated (GRSSRxx-DL77516 models accommodate one bulb)	each \$59
RED-UCTD-120	250 Watt Red Bulb, Uncoated (GRSSRxx-DL77516 models accommodate one bulb)	each 58
RED-CTD-120	250 Watt Red Bulb, Coated (GRSSRxx-DL77516 models accommodate one bulb)	each 74

COLORS AND FINISHES – PAGE 241



Glo-Ray® Portable Heated Shelves

Whether you need a heated workspace or extra base heat in a pass-through or buffet area, Hatco's full line of Glo-Ray® Heated Shelf options can help you. Using a blanket heating element for an even temperature, the thermostatically-controlled base safely extends the holding time of your food.

Flexibility, style and quality mark these workhorses of the buffet. Available in a variety of widths and depths to meet your specific needs.

- Uniform heat distribution with a blanket-type element
- Built-in adjustable thermostat controls surface temperature
- Extruded aluminum base with stainless steel top – optional Hardcoat Aluminum surface
- Accessory 4" legs (Standard on 36" and wider models)
- Accessory slant leg kit and pan rail
- Model widths from 18" to 72"
- Model depths: 6", 7¾", 9¾", 12", 13¾", 15½", 15¾", 17½", 19½", 21½", 23½", 25½"
- Optional Designer Colors: Warm Red, Black, Gray Granite, White Granite, Navy Blue, Hunter Green, Antique Copper. Non-standard colors are non-returnable
- New optional Thermostat Guard available (GRS models only)



GRS-30-I in optional Designer Warm Red with Accessory pan rail and food pans

Quick-Ship Program Information Inside Back Cover

GLO-RAY PORTABLE HEATED SHELVES

Model	Dimensions W x H	Voltage Single Phase	Watts	Plugs	Approx. Ship Weight	List Price
19½" depth I – Standard 19½" depth accommodates 12" x 20" steam table pans						
GRS-18-I	18" x 2¾"	120	250	NEMA 5-15P	16 lbs.	\$1552
✓ GRS-24-I	24" x 2¾"	120	350	NEMA 5-15P	20 lbs.	1697
✓ GRS-30-I	30" x 2¾"	120	450	NEMA 5-15P	25 lbs.	1829
✓ GRS-36-I	36" x 5¾"	120	550	NEMA 5-15P	28 lbs.	1956
✓ GRS-42-I	42" x 5¾"	120	600	NEMA 5-15P	32 lbs.	2211
✓ GRS-48-I	48" x 5¾"	120	700	NEMA 5-15P	36 lbs.	2304
GRS-54-I	54" x 5¾"	120	800	NEMA 5-15P	42 lbs.	2482
GRS-60-I	60" x 5¾"	120	900	NEMA 5-15P	44 lbs.	2572
GRS-66-I	66" x 5¾"	120	1000	NEMA 5-15P	50 lbs.	2671
GRS-72-I	72" x 5¾"	120	1100	NEMA 5-15P	56 lbs.	2894
6" depth A						
GRS-18-A	18" x 2¾"	120	100	NEMA 5-15P	7 lbs.	\$1156
GRS-24-A	24" x 2¾"	120	125	NEMA 5-15P	11 lbs.	1193
GRS-30-A	30" x 2¾"	120	150	NEMA 5-15P	9 lbs.	1244
GRS-36-A	36" x 5¾"	120	175	NEMA 5-15P	11 lbs.	1287
GRS-42-A	42" x 5¾"	120	225	NEMA 5-15P	15 lbs.	1424
GRS-48-A	48" x 5¾"	120	250	NEMA 5-15P	16 lbs.	1466
GRS-54-A	54" x 5¾"	120	275	NEMA 5-15P	17 lbs.	1503
GRS-60-A	60" x 5¾"	120	300	NEMA 5-15P	18 lbs.	1536
GRS-66-A	66" x 5¾"	120	325	NEMA 5-15P	20 lbs.	1650
GRS-72-A	72" x 5¾"	120	350	NEMA 5-15P	22 lbs.	1675
7¾" depth B						
GRS-18-B	18" x 2¾"	120	100	NEMA 5-15P	10 lbs.	\$1196
GRS-24-B	24" x 2¾"	120	125	NEMA 5-15P	10 lbs.	1244
GRS-30-B	30" x 2¾"	120	150	NEMA 5-15P	12 lbs.	1309
GRS-36-B	36" x 5¾"	120	175	NEMA 5-15P	14 lbs.	1366
GRS-42-B	42" x 5¾"	120	225	NEMA 5-15P	19 lbs.	1503
GRS-48-B	48" x 5¾"	120	250	NEMA 5-15P	19 lbs.	1574
GRS-54-B	54" x 5¾"	120	275	NEMA 5-15P	20 lbs.	1603
GRS-60-B	60" x 5¾"	120	300	NEMA 5-15P	21 lbs.	1682
GRS-66-B	66" x 5¾"	120	325	NEMA 5-15P	26 lbs.	1707
GRS-72-B	72" x 5¾"	120	350	NEMA 5-15P	24 lbs.	1788

All Glo-Ray Portable Heated Shelf Models Feature:

- Pan Capacity (12" x 20"): GRS-18-I, -24-I = 1-pan
- GRS-30-I, -36-I = 2-pan
- GRS-42-I, -48-I = 3-pan
- GRS-54-I, -60-I = 4-pan
- GRS-66-I, -72-I = 5-pan

Cord Location: 6' cord and plug, located, center of side with switch.

OPTIONS AND ACCESSORIES – PAGE 57

GLO-RAY PORTABLE HEATED SHELVES continued...

Model	Dimensions W x H	Voltage Single Phase	Watts	Plugs	Approx. Ship Weight	List Price
9¾" depth C						
GRS-18-C	18" x 2¾"	120	125	NEMA 5-15P	9 lbs.	\$1603
GRS-24-C	24" x 2¾"	120	175	NEMA 5-15P	13 lbs.	1309
GRS-30-C	30" x 2¾"	120	225	NEMA 5-15P	14 lbs.	1380
GRS-36-C	36" x 5¾"	120	275	NEMA 5-15P	16 lbs.	1445
GRS-42-C	42" x 5¾"	120	300	NEMA 5-15P	18 lbs.	1603
GRS-48-C	48" x 5¾"	120	350	NEMA 5-15P	20 lbs.	1682
GRS-54-C	54" x 5¾"	120	400	NEMA 5-15P	22 lbs.	1719
GRS-60-C	60" x 5¾"	120	450	NEMA 5-15P	25 lbs.	1820
GRS-66-C	66" x 5¾"	120	500	NEMA 5-15P	28 lbs.	1876
GRS-72-C	72" x 5¾"	120	550	NEMA 5-15P	28 lbs.	1938
12" depth D						
GRS-18-D	18" x 2¾"	120	200	NEMA 5-15P	12 lbs.	\$1287
GRS-24-D	24" x 2¾"	120	250	NEMA 5-15P	15 lbs.	1380
GRS-30-D	30" x 2¾"	120	300	NEMA 5-15P	17 lbs.	1466
GRS-36-D	36" x 5¾"	120	350	NEMA 5-15P	20 lbs.	1539
GRS-42-D	42" x 5¾"	120	450	NEMA 5-15P	23 lbs.	1712
GRS-48-D	48" x 5¾"	120	500	NEMA 5-15P	26 lbs.	1804
GRS-54-D	54" x 5¾"	120	550	NEMA 5-15P	30 lbs.	1879
GRS-60-D	60" x 5¾"	120	600	NEMA 5-15P	34 lbs.	1959
GRS-66-D	66" x 5¾"	120	650	NEMA 5-15P	36 lbs.	2041
GRS-72-D	72" x 5¾"	120	700	NEMA 5-15P	37 lbs.	2121
13¾" depth E						
GRS-18-E	18" x 2¾"	120	200	NEMA 5-15P	13 lbs.	\$1340
GRS-24-E	24" x 2¾"	120	250	NEMA 5-15P	14 lbs.	1444
GRS-30-E	30" x 2¾"	120	300	NEMA 5-15P	18 lbs.	1523
GRS-36-E	36" x 5¾"	120	350	NEMA 5-15P	22 lbs.	1624
GRS-42-E	42" x 5¾"	120	450	NEMA 5-15P	26 lbs.	1804
GRS-48-E	48" x 5¾"	120	500	NEMA 5-15P	29 lbs.	1899
GRS-54-E	54" x 5¾"	120	550	NEMA 5-15P	31 lbs.	1996
GRS-60-E	60" x 5¾"	120	600	NEMA 5-15P	36 lbs.	2085
GRS-66-E	66" x 5¾"	120	650	NEMA 5-15P	38 lbs.	2164
GRS-72-E	72" x 5¾"	120	700	NEMA 5-15P	40 lbs.	2271

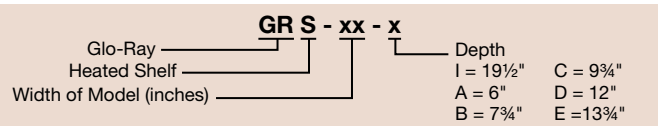



Glo-Ray® Portable Heated Shelves

continued



GRS-60-I



GRS-30-I in optional Designer Black with Accessory food pans, shown below a GRAH-36 Strip Heater in optional Designer Warm Red, infinite switch and Accessory C-leg stand

GLO-RAY PORTABLE HEATED SHELVES continued...

Model	Dimensions W x H	Voltage		Plug	Approx. Ship Weight	List Price
		Single Phase	Watts			
15½" depth F						
GRS-18-F	18" x 2¾"	120	200	NEMA 5-15P	14 lbs.	\$1402
GRS-24-F	24" x 2¾"	120	250	NEMA 5-15P	17 lbs.	1486
GRS-30-F	30" x 2¾"	120	300	NEMA 5-15P	22 lbs.	1592
GRS-36-F	36" x 5⅜"	120	350	NEMA 5-15P	25 lbs.	1682
GRS-42-F	42" x 5⅜"	120	450	NEMA 5-15P	26 lbs.	1883
GRS-48-F	48" x 5⅜"	120	500	NEMA 5-15P	32 lbs.	1982
GRS-54-F	54" x 5⅜"	120	550	NEMA 5-15P	38 lbs.	2103
GRS-60-F	60" x 5⅜"	120	600	NEMA 5-15P	39 lbs.	2202
GRS-66-F	66" x 5⅜"	120	650	NEMA 5-15P	42 lbs.	2287
GRS-72-F	72" x 5⅜"	120	700	NEMA 5-15P	46 lbs.	2423
15¼" depth G						
GRS-18-G	18" x 2¾"	120	225	NEMA 5-15P	17 lbs.	\$1426
GRS-24-G	24" x 2¾"	120	300	NEMA 5-15P	18 lbs.	1541
GRS-30-G	30" x 2¾"	120	375	NEMA 5-15P	21 lbs.	1650
GRS-36-G	36" x 5⅜"	120	450	NEMA 5-15P	27 lbs.	1753
GRS-42-G	42" x 5⅜"	120	525	NEMA 5-15P	29 lbs.	1978
GRS-48-G	48" x 5⅜"	120	600	NEMA 5-15P	33 lbs.	2090
GRS-54-G	54" x 5⅜"	120	675	NEMA 5-15P	38 lbs.	2208
GRS-60-G	60" x 5⅜"	120	750	NEMA 5-15P	42 lbs.	2322
GRS-66-G	66" x 5⅜"	120	825	NEMA 5-15P	47 lbs.	2342
GRS-72-G	72" x 5⅜"	120	900	NEMA 5-15P	46 lbs.	2529
17½" depth H						
GRS-18-H	18" x 2¾"	120	225	NEMA 5-15P	16 lbs.	\$1481
GRS-24-H	24" x 2¾"	120	300	NEMA 5-15P	18 lbs.	1617
GRS-30-H	30" x 2¾"	120	375	NEMA 5-15P	21 lbs.	1730
GRS-36-H	36" x 5⅜"	120	450	NEMA 5-15P	27 lbs.	1879
GRS-42-H	42" x 5⅜"	120	525	NEMA 5-15P	32 lbs.	2088
GRS-48-H	48" x 5⅜"	120	600	NEMA 5-15P	35 lbs.	2223
GRS-54-H	54" x 5⅜"	120	675	NEMA 5-15P	40 lbs.	2347
GRS-60-H	60" x 5⅜"	120	750	NEMA 5-15P	44 lbs.	2470
GRS-66-H	66" x 5⅜"	120	825	NEMA 5-15P	49 lbs.	2507
GRS-72-H	72" x 5⅜"	120	900	NEMA 5-15P	50 lbs.	2719

All Glo-Ray Portable Heated Shelf Models Feature:

Cord Location: 6' cord and plug, located, center of side with switch.

OPTIONS AND ACCESSORIES – PAGE 57

GLO-RAY PORTABLE HEATED SHELVES continued...

Model	Dimensions W x H	Voltage		Plug	Approx. Ship Weight	List Price
		Single Phase	Watts			
21½" depth J						
GRS-18-J	18" x 2¾"	120	300	NEMA 5-15P	19 lbs.	\$1683
GRS-24-J	24" x 2¾"	120	375	NEMA 5-15P	24 lbs.	1775
GRS-30-J	30" x 2¾"	120	450	NEMA 5-15P	30 lbs.	1915
GRS-36-J	36" x 5⅜"	120	525	NEMA 5-15P	33 lbs.	2050
GRS-42-J	42" x 5⅜"	120	675	NEMA 5-15P	39 lbs.	2315
GRS-48-J	48" x 5⅜"	120	750	NEMA 5-15P	45 lbs.	2441
GRS-54-J	54" x 5⅜"	120	825	NEMA 5-15P	49 lbs.	2605
GRS-60-J	60" x 5⅜"	120	900	NEMA 5-15P	53 lbs.	2731
GRS-66-J	66" x 5⅜"	120	975	NEMA 5-15P	60 lbs.	2877
GRS-72-J	72" x 5⅜"	120	1050	NEMA 5-15P	64 lbs.	3062
23½" depth K						
GRS-18-K	18" x 2¾"	120	325	NEMA 5-15P	19 lbs.	\$1764
GRS-24-K	24" x 2¾"	120	425	NEMA 5-15P	27 lbs.	1861
GRS-30-K	30" x 2¾"	120	525	NEMA 5-15P	33 lbs.	2006
GRS-36-K	36" x 5⅜"	120	625	NEMA 5-15P	36 lbs.	2158
GRS-42-K	42" x 5⅜"	120	750	NEMA 5-15P	43 lbs.	2423
GRS-48-K	48" x 5⅜"	120	850	NEMA 5-15P	48 lbs.	2580
GRS-54-K	54" x 5⅜"	120	950	NEMA 5-15P	52 lbs.	2730
GRS-60-K	60" x 5⅜"	120	1050	NEMA 5-15P	56 lbs.	2902
GRS-66-K	66" x 5⅜"	120	1150	NEMA 5-15P	68 lbs.	3073
GRS-72-K	72" x 5⅜"	120	1250	NEMA 5-15P	69 lbs.	3218
25½" depth L						
GRS-18-L	18" x 2¾"	120	350	NEMA 5-15P	22 lbs.	\$1850
GRS-24-L	24" x 2¾"	120	475	NEMA 5-15P	26 lbs.	1938
GRS-30-L	30" x 2¾"	120	600	NEMA 5-15P	33 lbs.	2095
GRS-36-L	36" x 5⅜"	120	725	NEMA 5-15P	37 lbs.	2269
GRS-42-L	42" x 5⅜"	120	825	NEMA 5-15P	43 lbs.	2545
GRS-48-L	48" x 5⅜"	120	950	NEMA 5-15P	50 lbs.	2720
GRS-54-L	54" x 5⅜"	120	1075	NEMA 5-15P	58 lbs.	2891
GRS-60-L	60" x 5⅜"	120	1200	NEMA 5-15P	60 lbs.	3058
GRS-66-L	66" x 5⅜"	120	1325	NEMA 5-15P	64 lbs.	3278
GRS-72-L	72" x 5⅜"	120	1450	NEMA 5-15P	69 lbs.	3401

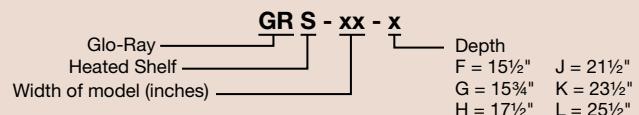



Glo-Ray® Designer Portable Heated Shelves

Using a blanket heating element for an even temperature, the thermostatically-controlled base safely extends the holding time of your food. Hatco's Designer Portable Heated Shelves can blend into any décor.

- Built-in adjustable thermostatic controls
- Rounded edges and Hardcoat Aluminum surface offer a modern style for front-of-the-house applications
- Model widths from 30 1/4" to 78 1/4"
- Optional Dark Gray corner caps (black Standard) and Designer Color inset panels available
- 4" legs Standard on 30" and wider models

GR2S-30 with optional Designer Hunter Green inset panels and Accessory pizza pans



GLO-RAY DESIGNER PORTABLE HEATED SHELVES

Model [Ⓜ]	Dimensions (W x D x H) Height includes legs	Voltage Single Phase	Watts	Plug	Approx. Ship Weight	List Price
GR2S-24	30 1/4" x 27" x 4"	120	350	NEMA 5-15P	37 lbs.	\$3579
GR2S-30	36 1/4" x 27" x 7"	120	450	NEMA 5-15P	40 lbs.	3846
GR2S-36	42 1/4" x 27" x 7"	120	550	NEMA 5-15P	45 lbs.	4118
GR2S-42	48 1/4" x 27" x 7"	120	600	NEMA 5-15P	51 lbs.	4544
GR2S-48	54 1/4" x 27" x 7"	120	700	NEMA 5-15P	56 lbs.	4818
GR2S-54	60 1/4" x 27" x 7"	120	800	NEMA 5-15P	61 lbs.	5079
GR2S-60	66 1/4" x 27" x 7"	120	900	NEMA 5-15P	67 lbs.	5351
GR2S-66	72 1/4" x 27" x 7"	120	1000	NEMA 5-15P	75 lbs.	5617
GR2S-72	78 1/4" x 27" x 7"	120	1100	NEMA 5-15P	82 lbs.	5888

[Ⓜ] When no color is specified, color inset panels and corner caps will be black.

All Glo-Ray Designer Portable Heated Shelf Models Feature:

Pan Capacity (12" x 20"): GR2S-24 = 1-pan
 GR2S-30, -36 = 2-pan
 GR2S-42, -48 = 3-pan
 GR2S-54, -60 = 4-pan
 GR2S-66, -72 = 5-pan

Usable Heated Shelf Space: (Width of unit minus 6 3/8") x 21 1/4"D.

Cord Location: 6' cord and plug located on center of bottom on control side.

OPTIONS (available at time of purchase only - not available)

Designer Colors (top surface not painted) – Clear Anodized standard – Non-standard colors are non-returnable –

RED	Warm Red	\$298
BLACK	Black	298
GRAY	Gray Granite	298
WHITE	White Granite	298
NAVY	Navy Blue	298
GREEN	Hunter Green	298
COPPER	Antique Copper	298

Designer Inset Panel colors, GR2S models – Non-standard colors are non-returnable – Black standard –

RED	Warm Red	No Charge
GRAY	Gray Granite	No Charge
WHITE	White Granite	No Charge
NAVY	Navy Blue	No Charge
GREEN	Hunter Green	No Charge
COPPER	Antique Copper	No Charge

Designer Corner Caps, GR2S models – Non-standard colors are non-returnable – Black standard –

DKGRAY	Dark Gray Corner Caps	No Charge
--------	-----------------------	-----------

Hardcoat Aluminum surface in lieu of Stainless Steel on standard 19 1/2" deep GRS models only (please consult factory for pricing of other depths)

HC 18-42	GRS-18 through GRS-42	\$348
HC 48-72	GRS-48 through GRS-72	592
GRS-RECTH	Thermostat Guard (GRS models only)	No Charge



ACCESSORIES (available for purchase at any time)

GRS-LEGS	4" Adjustable Legs (GRS models only, standard on units GRS-36 and wider)	\$ 98
2SD-LEGS	4" Adjustable Legs for GR2S-24 (standard on GR2S-30 and wider)	178
GRS-SLANT	Slant Leg Kit for models 12" deep or deeper (GRS models only)	47
Pan Rail for – 19 1/2" deep GRS models only –		
2 RAIL	2-pan	\$307
3 RAIL	3-pan	332
4 RAIL	4-pan	618
5 RAIL	5-pan	640
THRUSHelf	Bolt and fender washer leg accessory kit for attaching one GRS unit to a wire rack shelf	\$22

FOOD PANS AND TRIVETS – PAGE 240

COLORS AND FINISHES – PAGE 241

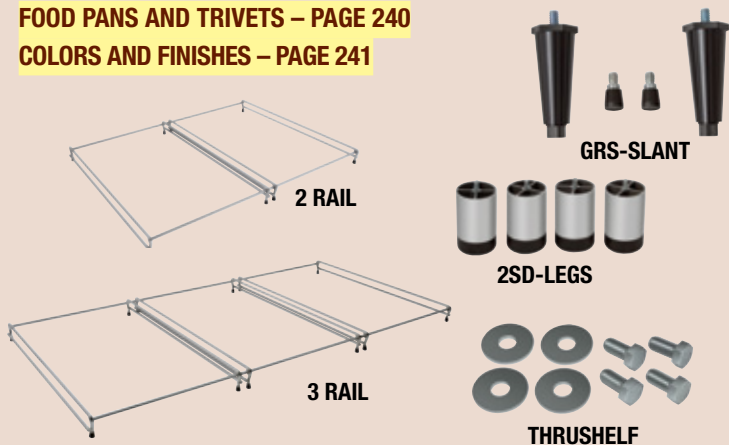

GR 2 S - xx
 Glo-Ray Designer ——— Width of Heated Surface (inches)
 Heated Shelf



Glo-Ray® Portable Rectangular Heated Simulated Stone Shelves

Match the heat zone to your countertops with Hatco's Glo-Ray® Simulated Stone Portable Rectangular Heated Shelves. These portable foodsafe shelves come in three simulated stone colors and are ideal for buffet lines or as hors d'oeuvre displays. These unique warmers will safely hold food hot while blending in with your décor.

- Made of approved foodsafe materials
- Features a lighted rocker switch and thermostatically-controlled heated base to help hold your food hot and delicious
- Models with simulated stone are Swanstone® and Dekton®



GRSS-3618 in optional Bermuda Sand simulated stone (view of base)



GRSS-3618 with optional Dekton® Soke stone surface

GLO-RAY SIMULATED STONE PORTABLE RECTANGULAR HEATED SHELVES

Model	Dimensions W x D x H	Voltage Single Phase	Watts	Plug	Approx. Ship Weight	List Price
GRSS-2418	23 ⁷ / ₈ " x 17 ⁷ / ₈ " x 2 ¹ / ₂ "	120	635	NEMA 5-15P	27 lbs.	\$3023
GRSS-3018	29 ⁷ / ₈ " x 17 ⁷ / ₈ " x 2 ¹ / ₂ "	120	780	NEMA 5-15P	30 lbs.	3165
GRSS-3618	35 ⁷ / ₈ " x 17 ⁷ / ₈ " x 2 ¹ / ₂ "	120	930	NEMA 5-15P	35 lbs.	3302
GRSS-4818‡	47 ⁷ / ₈ " x 17 ⁷ / ₈ " x 6 ¹ / ₄ "	120	1270	NEMA 5-15P	45 lbs.	3584
GRSS-6018‡	59 ⁷ / ₈ " x 17 ⁷ / ₈ " x 6 ¹ / ₄ "	120	1560	NEMA 5-20P	56 lbs.	4682
GRSS-7218‡	71 ⁷ / ₈ " x 17 ⁷ / ₈ " x 6 ¹ / ₄ "	120	1860	NEMA 5-20P	68 lbs.	4950

‡ Height includes standard 4" legs.

All Glo-Ray Simulated Stone Portable Rectangular Heated Shelf Models Feature:
Cord Location: 6' cord and plug, center of side with switch.

OPTIONS (available at time of purchase only)

Simulated stone colors – Non-standard colors are non-returnable – Night Sky standard –

SS-GGRAN	Gray Granite	No Charge
SS-BSAND	Bermuda Sand	No Charge

Dekton® Stone Colors – All Dekton surfaces are non-returnable –

GRSS-2418 – Rectangular Heated Shelves –

DOMOOS	Domoos	\$1066
REM	Rem	1066
SOKE	Soke	1066

GRSS-3018 – Rectangular Heated Shelves –

DOMOOS	Domoos	\$1245
REM	Rem	1245
SOKE	Soke	1245

GRSS-3618 – Rectangular Heated Shelves –

DOMOOS	Domoos	\$1540
REM	Rem	1540
SOKE	Soke	1540

GRSS-4818 – Rectangular Heated Shelves –

DOMOOS	Domoos	\$1683
REM	Rem	1683
SOKE	Soke	1683

GRSS-6018 – Rectangular Heated Shelves –

DOMOOS	Domoos	\$2028
REM	Rem	2028
SOKE	Soke	2028

GRSS-7218 – Rectangular Heated Shelves –

DOMOOS	Domoos	\$2375
REM	Rem	2375
SOKE	Soke	2375

COLORS AND FINISHES – PAGE 241

Dekton® stone surfaces that are available for these models:

Domoos



Rem



Soke

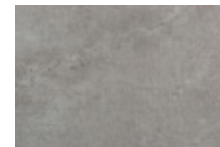

Note: Due to the natural texture, patterns may vary.

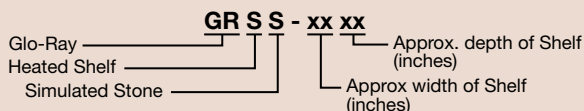



Portable Rectangular Heated Base Glass Shelves

The Hatco Heated Base Glass Portable Rectangular Shelves have a heated ceramic glass surface to create uniform heat across the entire surface and are made of approved foodsafe materials. Adjustable thermostatic controls allow surface temperature ranging from 100° to 195°F to be controlled easily.

- Shelves are made of approved foodsafe materials
- Equipped with a Trim Ring that is available in stainless steel (Standard), Designer Black or White
- Lighted On/Off rocker switch
- All units come with a 6' cord and plug
- Surface is made of approved foodsafe materials



HBG-FS-24 shown with optional Black angled Food Stop (detail view) with **HBG-TRIM-BLK** optional Designer Black trim ring



HBG-2418 in Standard Black Glass and stainless steel trim ring



HBG-2418 with optional White Glass, Frame and Trim Ring

PORTABLE RECTANGULAR HEATED BASE GLASS SHELVES

Model	Dimensions W x D x H	Voltage Single Phase	Watts	Plug	Approx. Ship Weight	List Price
HBG-2418	24 $\frac{3}{8}$ " x 18 $\frac{3}{8}$ " x 2 $\frac{1}{2}$ "	120	425	NEMA 5-15P	29 lbs.	\$4041
HBG-3018	30 $\frac{3}{8}$ " x 18 $\frac{3}{8}$ " x 2 $\frac{1}{2}$ "	120	525	NEMA 5-15P	33 lbs.	4227
HBG-3618 †	36 $\frac{3}{8}$ " x 18 $\frac{3}{8}$ " x 6 $\frac{1}{8}$ "	120	630	NEMA 5-15P	36 lbs.	4409
HBG-4818 ‡≈	48 $\frac{3}{8}$ " x 18 $\frac{3}{8}$ " x 6 $\frac{1}{8}$ "	120	850	NEMA 5-15P	42 lbs.	4778
HBG-6018 ‡≈	60 $\frac{3}{8}$ " x 18 $\frac{3}{8}$ " x 6 $\frac{1}{8}$ "	120	1050	NEMA 5-15P	60 lbs.	5145
HBG-7218 ‡≈	72 $\frac{3}{8}$ " x 18 $\frac{3}{8}$ " x 6 $\frac{1}{8}$ "	120	1260	NEMA 5-15P	68 lbs.	5512

† Height includes standard 4" legs.

≈ Units 48" and larger are constructed of two equal sized pieces of glass which create a seam.

All Portable Rectangular Heated Base Glass Shelf Models Feature:

Cord Location: 6' cord and plug, center of the side with switch.

OPTIONS (available at time of purchase only)

Ceramic Glass Color – Non-standard colors are non-returnable – Black standard –

HBG-GLASS-WHT	White	No Charge
----------------------	-------	-----------

Angled Food Stop keeps product on the heat zone – Choose size/color

24"	HBG-FS-24	Designer Black	each \$222
30"	HBG-FS-30	Designer Black	each 264
36"	HBG-FS-36	Designer Black	each 307
48"	HBG-FS-48	Designer Black	each 355
60"	HBG-FS-60	Designer Black	each 402
72"	HBG-FS-72	Designer Black	each 453
24"	HBG-FSW-24	White	each 222
30"	HBG-FSW-30	White	each 264
36"	HBG-FSW-36	White	each 307
48"	HBG-FSW-48	White	each 355
60"	HBG-FSW-60	White	each 402
72"	HBG-FSW-72	White	each 453

Trim Ring – Stainless Steel standard

HBG-TRIM-BLK	Designer Black	\$73
HBG-TRIM-WHT	White	73

Frame (base) color – Non-standard colors are non-returnable – Black standard –

HBG-FRAME-WHT	White	No Charge
----------------------	-------	-----------

COLORS AND FINISHES – PAGE 241

HBG - xx xx





Heated Glass Modular Shelf

Hatco's Heated Glass Modular Shelf creates uniform heat across the entire top surface. The new design uses a modular system, so units can be placed side-by-side. This allows for marvelous flexibility in buffet areas.

- Unit's glass surface accommodates one 12" x 20" food pan
- Thermostatically-controlled with five settings: 130°F, 150°F, 165°F, 185°F and 200°F
- Durable stainless steel housing
- Simple design for easy cleaning and maintenance
- All units come with a 6' cord and plug, located under control side of unit



HGSM-1P

Quick-Ship Program Information *Inside Back Cover*

HEATED BASE GLASS MODULAR PORTABLE GLASS SHELF

Model ^o	Dimensions W x D x H	Voltage Single Phase	Watts	Plug	Approx. Ship Weight	List Price
HGSM-1P	15 ³ / ₄ " x 23 ³ / ₈ " x 2 ⁵ / ₁₆ "	120	300	NEMA 5-15P	16 lbs.	\$1558

^o No direct food contact on surface - use pans.

The Heated Base Glass Modular Portable Shelf model feature:
Cord Location: 6' cord and plug, located under control side of unit.





Built-In Flush Mount Ceramic Glass Heated Shelves

Give your operation a seamless look with the Built-In Flush Mount Ceramic Glass Heated Shelf. The bracket mounting hardware gives a true flush mount appearance that will safely hold food hot while blending with your decor. It is a must for buffet lines in cafeterias, restaurants and more!

- Standard Black or optional white Ceramic Glass surface
- All models have a Ceramic Glass surface and are bottom mount, flush with the countertop
- Blanket-type element with thermostatically-controlled heated base results in uniform heat to extend food holding times
- Insulation keeps heat at the holding surface while a built-in adjustable thermostat controls surface temperature.
- Standard control includes thermostat, lighted rocker switch and mounting brackets
- 3' Conduit is standard – Option: with ITC Control Boxes only, 6' and 10' lengths are available



HSBF-GL-4818
in standard
Black Glass



HSBF-GL-4818
in optional
White Glass

BUILT-IN FLUSH TOP CERAMIC GLASS HEATED SHELVES

Model ^M	Overall Shelf Dimensions (includes brackets) W x D x H	Heated Shelf Space W x D	Cutout Size (with 3/8" corner radii) W x D	Voltage Single Phase	Watts	Amps	List Price
HSBF-GL-2418	27" x 21 1/8" x 5 1/2"	24" x 18"	24 1/4" x 18 3/8"	120	425	3.5	\$4421
HSBF-GL-3018	33" x 21 1/8" x 5 1/2"	30" x 18"	30 1/4" x 18 3/8"	120	525	4.4	4607
HSBF-GL-3618	39" x 21 1/8" x 5 1/2"	36" x 18"	36 1/4" x 18 3/8"	120	630	5.3	4804
HSBF-GL-4818	51" x 21 1/8" x 5 1/2"	48" x 18"	48 1/4" x 18 3/8"	120	850	7.1	5266

^M Recommended for use in a metallic countertop. For other surfaces, verify that the material is suitable for temperatures up to 200°F. Hatco is not responsible for counter damage caused by heat from the warmer.

All Built-In Flush Mount Ceramic Glass Heated Shelf Models Feature:

Control Box: Thermostat Control with Lighted Rocker Switch and 3' conduit

Cord Location: Cord is attached to Control Box.

Cord and Plug: 6' cord and plug (NEMA 5-15P).

NOTE: Install Remote Box outside Heat Zone or damage will occur.

OPTIONS (available at time of purchase only)

Ceramic Glass Color – Black standard –

HSBF-GLASS-WHT	White	No Charge
Designer Color for Flush Mount Control Bezel – Stainless Steel standard – Non-standard colors are non-returnable		
RED	Warm Red	\$ 69
BLACK	Black	69
GRAY	Gray Granite	69
WHITE	White Granite	69
NAVY	Navy Blue	69
GREEN	Hunter Green	69
COPPER	Antique Copper	69

HSBF-FLUSH-ITC Stainless steel Flush Mount Recessed Electronic Control Box with lighted On/Off rocker switch and angled recessed controls (6 7/16" W x 7 13/16" H x 5 9/32" D) **299**

HSBF-SMFLUSH-ITC Flush Mount Electronic Control Box with lighted On/Off rocker switch (8 1/2" W x 4" H x 3 13/16" D) **299**

HSBF-FLUSH-TSTAT Stainless steel Flush Mount Recessed Thermostatic Control Box with lighted On/Off rocker switch and angled recessed controls (6 7/16" W x 7 13/16" H x 4 17/32" D) **No Charge**

HSBF-SMFLUSH-TSTAT Flush Mount Thermostatic Control Box with lighted On/Off rocker switch (8 1/2" W x 3 11/16" H x 3 13/16" D) **No Charge**

COND-6 6' Conduit (3' standard) – used with Flush Mount and Small Flush Mount ITC Control Boxes only) **\$ 67**

COND-10 10' Conduit (3' standard) (used with Flush Mount and Small Flush Mount ITC Control Boxes only) **132**

COLORS AND FINISHES – PAGE 241



HSBF-FLUSH-ITC



HSBF-FLUSH-TSTAT



HSBF-SMFLUSH-ITC



HSBF-SMFLUSH-TSTAT

OPTIONAL CONTROL BOX CUTOUT DIMENSIONS

Model	Width	Height	Depth
HSBF-FLUSH-ITC	5 7/8"	6 3/8"	4 3/8"
HSBF-FLUSH-TSTAT	5 7/8"	6 3/8"	4"
HSBF-SMFLUSH-ITC	6 3/4"	3 3/4"	3 3/8"
HSBF-SMFLUSH-TSTAT	6 3/4"	3 1/16"	3 25/64"





Built-In Flush Mount Hardcoat Aluminum Heated Shelves

Give your operation a seamless look with the Built-In Flush Mount Hardcoat Aluminum Heated Shelf. The bracket mounting hardware gives a true flush mount appearance that will safely hold food hot while blending with your decor. It is a must for buffet lines in cafeterias, restaurants and more!

- All models have a Hardcoat Aluminum surface and are bottom mount, flush with the countertop
- Blanket-type element with thermostatically-controlled heated base results in uniform heat to extend food holding times.
- Insulation keeps heat at the holding surface while a built-in adjustable thermostat controls surface temperature
- Standard control includes thermostat, lighted rocker switch and mounting brackets
- 3' Conduit is standard – Option: with ITC Control Boxes only, 6' and 10' lengths are available

NOTE: Install Remote Box outside Heat Zone or damage will occur.



HSBF-HC-4818

BUILT-IN FLUSH MOUNT HARDCOAT ALUMINUM HEATED SHELVES

Model ^M	Overall Shelf Dim. (includes brackets) W x D x H	Heated Shelf Space W x D	Cutout Size (with 3/8" corner radii) W x D	Voltage Single Phase	Watts	Amps	List Price
HSBF-HC-2418	27 1/8" x 21 1/8" x 5 11/32"	24" x 18"	24 3/8" x 18 3/8"	120	425	3.5	\$2726
HSBF-HC-2424	27 1/8" x 27 1/8" x 5 11/32"	24" x 24"	24 3/8" x 24 3/8"	120	680	5.7	2737
HSBF-HC-2430	27 1/8" x 33 1/8" x 5 11/32"	24" x 30"	24 3/8" x 30 3/8"	120	790	6.6	2972
HSBF-HC-3018	33 1/8" x 21 1/8" x 5 11/32"	30" x 18"	30 3/8" x 18 3/8"	120	525	4.4	2904
HSBF-HC-3024	33 1/8" x 27 1/8" x 5 11/32"	30" x 24"	30 3/8" x 24 3/8"	120	815	6.8	2916
HSBF-HC-3030	33 1/8" x 33 1/8" x 5 11/32"	30" x 30"	30 3/8" x 30 3/8"	120	950	7.9	3236
HSBF-HC-3618	39 1/8" x 21 1/8" x 5 11/32"	36" x 18"	36 3/8" x 18 3/8"	120	630	5.3	3087
HSBF-HC-3624	39 1/8" x 27 1/8" x 5 11/32"	36" x 24"	36 3/8" x 24 3/8"	120	950	7.9	3101
HSBF-HC-3630	39 1/8" x 33 1/8" x 5 11/32"	36" x 30"	36 3/8" x 30 3/8"	120	1110	9.3	3602
HSBF-HC-4218	45 1/8" x 21 1/8" x 5 11/32"	42" x 18"	42 3/8" x 18 3/8"	120	735	6.1	3240
HSBF-HC-4224	45 1/8" x 27 1/8" x 5 11/32"	42" x 24"	42 3/8" x 24 3/8"	120	1090	9.1	3256
HSBF-HC-4230	45 1/8" x 33 1/8" x 5 11/32"	42" x 30"	42 3/8" x 30 3/8"	120	1270	10.6	3956
HSBF-HC-4818	51 1/8" x 21 1/8" x 5 11/32"	48" x 18"	48 3/8" x 18 3/8"	120	850	7.1	3413
HSBF-HC-4824	51 1/8" x 27 1/8" x 5 11/32"	48" x 24"	48 3/8" x 24 3/8"	120	1225	10.2	3430
HSBF-HC-4830	51 1/8" x 33 1/8" x 5 11/32"	48" x 30"	48 3/8" x 30 3/8"	120	1430	11.9	4263

^M Recommended for use in a metallic countertop. For other surfaces, verify that the material is suitable for temperatures up to 200°F. Hatco is not responsible for counter damage caused by heat from the warmer.

All Built-In Flush Mount Hardcoat Aluminum Heated Shelf Models Feature:

Control Box: Thermostat Control with Lighted Rocker Switch and 3' conduit
Cord Location: Cord is attached to Control Box.
Cord and Plug: 6' cord and plug (NEMA 5-15P).

OPTIONS (available at time of purchase only)

Designer Color for Flush Mount Control Bezel – Stainless Steel standard – Non-standard colors are non-returnable –

RED	Warm Red	\$ 69
BLACK	Black	69
GRAY	Gray Granite	69
WHITE	White Granite	69
NAVY	Navy Blue	69
GREEN	Hunter Green	69
COPPER	Antique Copper	69

HSBF-FLUSH-ITC Stainless steel Flush Mount Recessed Electronic Control Box with lighted On/Off rocker switch and angled recessed controls (6 7/16" W x 7 13/16" H x 5 9/32" D) **299**

HSBF-SMFLUSH-ITC Flush Mount Electronic Control Box with lighted On/Off rocker switch (8 1/2" W x 4" H x 3 13/16" D) **299**

HSBF-FLUSH-TSTAT Stainless steel Flush Mount Recessed Thermostatic Control Box with lighted On/Off rocker switch and angled recessed controls (6 7/16" W x 7 13/16" H x 4 17/32" D) **No Charge**

HSBF-SMFLUSH-TSTAT Flush Mount Thermostatic Control Box with lighted On/Off rocker switch (8 1/2" W x 3 11/16" H x 3 13/16" D) **No Charge**

COND-6 6' Conduit (3' standard) – used with Flush Mount and Small Flush Mount ITC Control Boxes only) **\$ 67**

COND-10 10' Conduit (3' standard) (used with Flush Mount and Small Flush Mount ITC Control Boxes only) **132**

COLORS AND FINISHES – PAGE 241

OPTIONAL CONTROL BOX CUTOUT DIMENSIONS

Model	Width	Height	Depth
HSBF-FLUSH-ITC	5 5/8"	6 3/8"	4 7/8"
HSBF-FLUSH-TSTAT	5 5/8"	6 3/8"	4"
HSBF-SMFLUSH-ITC	6 3/4"	3 3/4"	3 5/8"
HSBF-SMFLUSH-TSTAT	6 3/4"	3 7/8"	3 25/64"



HSBF-FLUSH-ITC



HSBF-FLUSH-TSTAT



HSBF-SMFLUSH-ITC



HSBF-SMFLUSH-TSTAT





Built-In Flush Mount Simulated Stone Heated Shelves

Give your operation a seamless look with the Built-In Flush Mount Simulated Stone Heated Shelf. The bracket mounting hardware gives a true flush mount appearance that will safely hold food hot while blending with your decor. It is a must for buffet lines in cafeterias, restaurants and more!

- The Simulated Stone unit mounts directly to underside of appropriate countertop material
- Simulated stone is Swanstone®
- Blanket-type element with thermostatically-controlled heated base results in uniform heat to extend food holding times
- Insulation keeps heat at the holding surface while a built-in adjustable thermostat controls surface temperature.
- Standard control includes thermostat, lighted rocker switch and mounting brackets
- 3' Conduit is standard – Option: with ITC Control Boxes only, 6' and 10' lengths are available

HSBF-SS-4818
in standard Night Sky



HSBF-SS-4818
in optional Gray Granite

HSBF-SS-4818
in optional Bermuda Sand



BUILT-IN FLUSH MOUNT SIMULATED STONE HEATED SHELVES

Model ^M	Overall Shelf Dimensions (includes brackets) W x D x H	Heated Shelf Space W x D	Cutout Size (with 3/8" corner radii) W x D	Voltage Single Phase	Watts	Amps	List Price
HSBF-SS-2418	27" x 21 x 5 5/8"	24" x 18"	24 3/8" x 18 3/8"	120	635	5.3	\$3262
HSBF-SS-3018	33" x 21 x 5 5/8"	30" x 18"	30 3/8" x 18 3/8"	120	780	6.5	3395
HSBF-SS-3618	39" x 21 x 5 5/8"	36" x 18"	36 3/8" x 18 3/8"	120	930	7.8	3539
HSBF-SS-4818	51" x 21 x 5 5/8"	48" x 18"	48 3/8" x 18 3/8"	120	1270	10.6	4011

^M Recommended for use in a metallic countertop. For other surfaces, verify that the material is suitable for temperatures up to 200°F. Hatco is not responsible for counter damage caused by heat from the warmer.

All Built-In Flush Mount Simulated Stone Heated Shelf Models Feature

Control Box: Thermostat Control with Lighted Rocker Switch and 3' conduit

Cord Location: Cord is attached to Control Box.

Cord and Plug: 6' cord and plug (NEMA 5-15P).

NOTE: Install Remote Box outside Heat Zone or damage will occur.

OPTIONS (available at time of purchase only)

Simulated stone colors – Non-standard colors are non-returnable – Night Sky standard –

SS-GGRAN	Gray Granite	No Charge
SS-BSAND	Bermuda Sand	No Charge

Designer Color for Flush Mount Control Bezel – Stainless Steel standard –

Non-standard colors are non-returnable

RED	Warm Red	\$ 69
BLACK	Black	69
GRAY	Gray Granite	69
WHITE	White Granite	69
NAVY	Navy Blue	69
GREEN	Hunter Green	69
COPPER	Antique Copper	69

HSBF-FLUSH-ITC	Stainless steel Flush Mount Recessed Electronic Control Box with lighted On/Off rocker switch and angled recessed controls (6 7/16" W x 7 13/16" H x 5 9/32" D)	299
-----------------------	---	------------

HSBF-SMFLUSH-ITC	Flush Mount Electronic Control Box with lighted On/Off rocker switch (8 1/2" W x 4" H x 3 13/16" D)	299
-------------------------	---	------------

HSBF-FLUSH-TSTAT	Stainless steel Flush Mount Recessed Thermostatic Control Box with lighted On/Off rocker switch and angled recessed controls (6 7/16" W x 7 13/16" H x 4 17/32" D)	No Charge
-------------------------	--	------------------

HSBF-SMFLUSH-TSTAT	Flush Mount Thermostatic Control Box with lighted On/Off rocker switch (8 1/2" W x 3 11/16" H x 3 15/16" D)	No Charge
---------------------------	---	------------------

COND-6	6' Conduit (3' standard) – used with Flush Mount and Small Flush Mount ITC Control Boxes only)	\$ 67
---------------	--	--------------

COND-10	10' Conduit (3' standard) (used with Flush Mount and Small Flush Mount ITC Control Boxes only)	132
----------------	--	------------

COLORS AND FINISHES – PAGE 241

OPTIONAL CONTROL BOX CUTOUT DIMENSIONS

Model	Width	Height	Depth
HSBF-FLUSH-ITC	5 7/8"	6 3/8"	4 7/8"
HSBF-FLUSH-TSTAT	5 7/8"	6 3/8"	4"
HSBF-SMFLUSH-ITC	6 3/4"	3 3/4"	3 5/8"
HSBF-SMFLUSH-TSTAT	6 3/4"	3 7/8"	3 25/64"



HSBF-FLUSH-ITC



HSBF-FLUSH-TSTAT



HSBF-SMFLUSH-ITC



HSBF-SMFLUSH-TSTAT





Glo-Ray® Built-In Rectangular Heated Simulated Stone Shelves

Match the heat zone to your countertops with these versatile shelves. These shelves are ideal for buffet lines or as hors d'oeuvre displays. These unique warmers will safely hold food hot while blending in with your décor.

- Shelves are made of approved foodsafe materials
- Features a lighted rocker switch and thermostatically-controlled heated base
- Includes Control Box with 3' conduit and 6' cord and plug
- Simulated stone is Swanstone®



GRSSB-3618 in optional Bermuda Sand built into a Bermuda Sand simulated stone countertop

NOTE: For any size GRSSB, the next larger size GRA or GR2A Strip Heater will fit over the top. For example, a GRSSB-3018 will require a GRA-36 or GR2A-36. The GRA will have a tight fit to the frame of the base. The GR2A will have approximately a 4" space.

Standard Control Box



Be sure to check out our Hot/Cold and Cold only Built-In Shelves for a seamless look

GLO-RAY BUILT-IN RECTANGULAR HEATED SIMULATED STONE SHELVES

Model M	Dimensions W x D x H	Voltage Single Phase	Watts	Plug	Approx. Ship Weight	List Price
GRSSB-2418	25 5/8" x 19 5/8" x 2 1/4"	120	635	NEMA 5-15P	30 lbs.	\$3262
GRSSB-3018	31 5/8" x 19 5/8" x 2 1/4"	120	780	NEMA 5-15P	43 lbs.	3395
GRSSB-3618	37 5/8" x 19 5/8" x 2 1/4"	120	930	NEMA 5-15P	48 lbs.	3539
GRSSB-4818	49 5/8" x 19 5/8" x 2 1/4"	120	1270	NEMA 5-15P	51 lbs.	4011
GRSSB-6018	61 5/8" x 19 5/8" x 2 1/4"	120	1560	NEMA 5-20P	64 lbs.	5264
GRSSB-7218	73 5/8" x 19 5/8" x 2 1/4"	120	1860	NEMA 5-20P	70 lbs.	5483

M Recommended for use in a metallic countertop. For other surfaces, verify that the material is suitable for temperatures up to 200°F. Hatco is not responsible for counter damage caused by heat from the warmer.

All Built-In Rectangular Heated Simulated Stone Shelf Built-In Models Feature:

Cord Location: Cord is attached to Control Box.

OPTIONS (available at time of purchase only)

Designer Color Bezel (Flush Mount Control Box, Bezel only) Stainless Steel standard – Non-standard colors are non-returnable –

RED	Warm Red	BLACK	Black	COPPER	Antique Copper	\$74
GRAY	Gray Granite	WHITE	White Granite			
NAVY	Navy Blue	GREEN	Hunter Green			

Simulated stone color – Non-standard colors are non-returnable – Night Sky standard –

SS-GGRAN	Gray Granite	SS-BSAND	Bermuda Sand	No Charge
SS-NSKY	Night Sky (standard)			

GRSSB-FLUSH-ITC	Flush Mount recessed Electronic Control Box with lighted On/Off rocker switch and angled recessed controls (6 13/32"W x 7 13/16"H x 4 13/16"D)	\$299
-----------------	--	-------

GRSSB-FLUSH-TSTAT	Flush Mount recessed Thermostatic Control Box with lighted On/Off rocker switch and angled recessed controls (6 13/32"W x 7 13/16"H x 4 1/8"D)	No Charge
-------------------	--	-----------

COND-6	6' Conduit (3' standard) – used with Flush Mount ITC Control Boxes only	67
--------	---	----

COND-10	10' Conduit (3' standard) – used with Flush Mount ITC Control Boxes only	132
---------	--	-----

GRSSB-REC	Built-In Heated Simulated Stone Shelf with 1/2" Recessed Top (Increases total height of model to 2 3/4")	No Charge
-----------	--	-----------



GRSSB-FLUSH-ITC



GRSSB-FLUSH-TSTAT

COLORS AND FINISHES – PAGE 241

GRSSB, GRSB, GRSBF COUNTERTOP CUTOUT DIMENSIONS

Model	Minimum Width	Maximum Width	Minimum Depth	Maximum Depth
GRS(S)B(F)-2418	24 3/8"	24 3/8"	18 5/8"	18 7/8"
GRS(S)B(F)-3018	30 3/8"	30 3/8"	18 5/8"	18 7/8"
GRS(S)B(F)-3618	36 3/8"	36 3/8"	18 5/8"	18 7/8"
GRS(S)B(F)-4818	48 3/8"	48 3/8"	18 5/8"	18 7/8"
GRS(S)B(F)-6018	60 3/8"	60 3/8"	18 5/8"	18 7/8"
GRS(S)B(F)-7218	72 3/8"	72 3/8"	18 5/8"	18 7/8"

OPTIONAL GRSSB, GRSB, GRSBF CONTROL BOX CUTOUT DIMENSIONS

Model	Width	Height	Depth
GRS(S)B(F)-FLUSH-ITC	5 7/8"	6 3/8"	4 3/4"
GRS(S)B(F)-FLUSH-TSTAT	5 7/8"	6 3/8"	4"

NOTE: Install Remote Box outside Heat Zone or damage will occur.





Built-In Rectangular Heated Base Glass Shelves

Hatco Built-In Heated Base Glass Shelves have a heated ceramic glass top to create uniform heat across the entire surface and are made of approved foodsafe materials. Adjustable thermostatic controls allow surface temperature to be controlled easily.

- Shelves are made of approved foodsafe materials
- Equipped with an attached Stainless Steel (standard) trim mounting ring (*Designer Black or White available*)
- Includes Control Box with 3' conduit and 6' cord and plug
- Lighted On/Off rocker switch



HBGB-2418 with optional *Designer Black Trim Ring*



HBGB-3618 with optional *White Glass and Trim Ring*

NOTE: For any size HBGB, the next larger size GRA or GR2A Strip Heater will fit over the top. For example, a HBGB-3018 will require a GRA-36 or GR2A-36. The GRA will have a tight fit to the frame of the base. The GR2A will have approximately a 4" space.

BUILT-IN RECTANGULAR HEATED BASE GLASS SHELVES

Model ^M	Dimensions (W x D x H)	Voltage (Single Phase)	Watts	Plug	Approx. Ship Weight	List Price
HBGB-2418	25 ³ / ₄ " x 19 ³ / ₄ " x 2 ¹ / ₄ "	120	425	NEMA 5-15P	32 lbs.	\$4421
HBGB-3018	31 ³ / ₄ " x 19 ³ / ₄ " x 2 ¹ / ₄ "	120	525	NEMA 5-15P	37 lbs.	4607
HBGB-3618	37 ³ / ₄ " x 19 ³ / ₄ " x 2 ¹ / ₄ "	120	630	NEMA 5-15P	40 lbs.	4804
HBGB-4818 ≈	49 ³ / ₄ " x 19 ³ / ₄ " x 2 ¹ / ₄ "	120	850	NEMA 5-15P	50 lbs.	5266
HBGB-6018 ≈	61 ³ / ₄ " x 19 ³ / ₄ " x 2 ¹ / ₄ "	120	1050	NEMA 5-15P	63 lbs.	5645
HBGB-7218 ≈	73 ³ / ₄ " x 19 ³ / ₄ " x 2 ¹ / ₄ "	120	1260	NEMA 5-15P	74 lbs.	6022



Standard Control Box

^M Recommended for use in a metallic countertop. For other surfaces, verify that the material is suitable for temperatures up to 200°F.

Hatco is not responsible for counter damage caused by heat from the warmer.

≈ Units 48" and larger are constructed of two equal sized pieces of glass which create a seam.

All Built-In Rectangular Heated Base Glass Shelf Models Feature:

Cord Location: Cord is attached to Control Box.

OPTIONS (available at time of purchase only)

Ceramic Glass Color – Black standard – Non-standard colors are non-returnable

HBGB-GLASS-WHT White **No Charge**

Bezel Color (Flush Mount Control Box, Bezel only) – Stainless Steel standard –

Non-standard colors are non-returnable –

HBGB-BEZEL-BLACK Black **\$ 74**

HBGB-BEZEL-WHITE White **74**

Trim Ring Color – Stainless Steel standard – Non-standard colors are non-returnable –

HBGB-TRIM-BLK *Designer Black* **69**

HBGB-TRIM-WHITE White **69**

HBGB-FLUSH-ITC Flush Mount recessed Electronic Control Box with lighted On/Off rocker switch and angled recessed controls (6¹³/₃₂"W x 7¹³/₁₆"H x 4¹³/₁₆"D) **299**

HBGB-FLUSH-TSTAT Flush Mount recessed Thermostatic Control Box with lighted On/Off rocker switch and angled recessed controls (6¹³/₃₂"W x 7¹³/₁₆"H x 4¹/₈"D) **No Charge**

COND-6 6' Conduit (3' standard) – used with Flush Mount ITC Control Boxes only **\$ 67**

COND-10 10' Conduit (3' standard) – used with Flush Mount ITC Control Boxes only **132**

HBGB-REC Built-In Heated Base Glass Shelf with Recessed Top **No Charge**



HBGB-FLUSH-ITC



HBGB-FLUSH-TSTAT

HBGB COUNTERTOP CUTOUT DIMENSIONS

Model	Minimum Width	Maximum Width	Minimum Depth	Maximum Depth
HBGB-2418	24 ⁵ / ₈ "	24 ⁷ / ₈ "	18 ⁵ / ₈ "	18 ⁷ / ₈ "
HBGB-3018	30 ⁵ / ₈ "	30 ⁷ / ₈ "	18 ⁵ / ₈ "	18 ⁷ / ₈ "
HBGB-3618	36 ⁵ / ₈ "	36 ⁷ / ₈ "	18 ⁵ / ₈ "	18 ⁷ / ₈ "
HBGB-4818	48 ⁵ / ₈ "	48 ⁷ / ₈ "	18 ⁵ / ₈ "	18 ⁷ / ₈ "
HBGB-6018	60 ⁵ / ₈ "	60 ⁷ / ₈ "	18 ⁵ / ₈ "	18 ⁷ / ₈ "
HBGB-7218	72 ⁵ / ₈ "	72 ⁷ / ₈ "	18 ⁵ / ₈ "	18 ⁷ / ₈ "

OPTIONAL CONTROL BOX CUTOUT DIMENSIONS

Model	Width	Height	Depth
HBGB-FLUSH-ITC	5 ⁷ / ₈ "	6 ³ / ₈ "	4 ⁷ / ₈ "
HBGB-FLUSH-TSTAT	5 ⁷ / ₈ "	6 ³ / ₈ "	4"

NOTE: Install Remote Box outside Heat Zone or damage will occur.

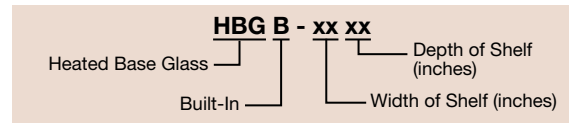



Glo-Ray® Built-In Rectangular Recessed Top Aluminum Heated Shelves

Let Hatco add heat to your serving surface with the Glo-Ray Rectangular Heated Shelves Built-In with Recessed Top. This 1/2" recessed top foodwarmer has a Hardcoat Aluminum surface and blanket-type element for uniform heat to extend your food holding time.

- Uniform heat distribution with Hardcoat Aluminum surface and blanket-type element
- Includes Control Box with 3' conduit and 6' cord and plug

- Standard controller includes control thermostat, illuminated power switch and mounting brackets
- Thermostatically-controlled heated base
- For use in countertops up to 1 1/4" thick



GRSB-24-I



Standard Control Box

NOTE: For any size GRSB, the next larger size GRA or GR2A Strip Heater will fit over the top. For example, a GRSB-30 will require a GRA-36 or GR2A-36. The GRA will have a tight fit to the frame of the base. The GR2A will have approximately a 4" space.

Be sure to check out our Hot/Cold and Cold only Built-In Shelves for a seamless look

Quick-Ship Program Information Inside Back Cover

GLO-RAY BUILT-IN RECTANGULAR RECESSED TOPALUMINUM HEATED SHELVES

Model ^M	Dimensions W x D x H	Cut-Out Dimensions		Voltage Single Phase	Watts	Approx. Ship Weight	List Price
		Min.-Max. Width	Min.-Max. Depth				
GRSB-24-F	25 1/2" x 17" x 2 7/8"	24 1/2"-24 3/4"	16"-16 1/4"	120	420	25 lbs.	\$2726
GRSB-24-I	25 1/2" x 21" x 2 7/8"	24 1/2"-24 3/4"	20"-20 1/4"	120	550	28 lbs.	2737
GRSB-24-O	25 1/2" x 31 1/2" x 2 7/8"	24 1/2"-24 3/4"	30 1/2"-30 3/4"	120	790	33 lbs.	2972
GRSB-30-F	31 1/2" x 17" x 2 7/8"	30 1/2"-30 3/4"	16"-16 1/4"	120	505	25 lbs.	2904
GRSB-30-I	31 1/2" x 21" x 2 7/8"	30 1/2"-30 3/4"	20"-20 1/4"	120	665	29 lbs.	2916
GRSB-30-O	31 1/2" x 31 1/2" x 2 7/8"	30 1/2"-30 3/4"	30 1/2"-30 3/4"	120	950	37 lbs.	3236
GRSB-36-F	37 1/2" x 17" x 2 7/8"	36 1/2"-36 3/4"	16"-16 1/4"	120	590	28 lbs.	3087
GRSB-36-I	37 1/2" x 21" x 2 7/8"	36 1/2"-36 3/4"	20"-20 1/4"	120	780	30 lbs.	3101
GRSB-36-O	37 1/2" x 31 1/2" x 2 7/8"	36 1/2"-36 3/4"	30 1/2"-30 3/4"	120	1110	37 lbs.	3602
GRSB-42-F	43 1/2" x 17" x 2 7/8"	42 1/2"-42 3/4"	16"-16 1/4"	120	685	30 lbs.	3240
GRSB-42-I	43 1/2" x 21" x 2 7/8"	42 1/2"-42 3/4"	20"-20 1/4"	120	885	37 lbs.	3256
GRSB-42-O	43 1/2" x 31 1/2" x 2 7/8"	42 1/2"-42 3/4"	30 1/2"-30 3/4"	120	1270	46 lbs.	3956
GRSB-48-F	49 1/2" x 17" x 2 7/8"	48 1/2"-48 3/4"	16"-16 1/4"	120	770	33 lbs.	3413
GRSB-48-I	49 1/2" x 21" x 2 7/8"	48 1/2"-48 3/4"	20"-20 1/4"	120	1000	40 lbs.	3430
GRSB-48-O	49 1/2" x 31 1/2" x 2 7/8"	48 1/2"-48 3/4"	30 1/2"-30 3/4"	120	1430	68 lbs.	4263
GRSB-54-I	55 1/2" x 21" x 2 7/8"	54 1/2"-54 3/4"	20"-20 1/4"	120	1110	40 lbs.	3599
GRSB-60-F	61 1/2" x 17" x 2 7/8"	60 1/2"-60 3/4"	16"-16 1/4"	120	950	40 lbs.	3766
GRSB-60-I	61 1/2" x 21" x 2 7/8"	60 1/2"-60 3/4"	20"-20 1/4"	120	1220	43 lbs.	3782
GRSB-60-O	61 1/2" x 31 1/2" x 2 7/8"	60 1/2"-60 3/4"	30 1/2"-30 3/4"	120	1750	64 lbs.	4955
GRSB-66-I	67 1/2" x 21" x 2 7/8"	66 1/2"-66 3/4"	20"-20 1/4"	120	1330	49 lbs.	3923
GRSB-72-F	73 1/2" x 17" x 2 7/8"	72 1/2"-72 3/4"	16"-16 1/4"	120	1130	43 lbs.	4069
GRSB-72-I	73 1/2" x 21" x 2 7/8"	72 1/2"-72 3/4"	20"-20 1/4"	120	1440	50 lbs.	4087
GRSB-72-O	73 1/2" x 31 1/2" x 2 7/8"	72 1/2"-72 3/4"	30 1/2"-30 3/4"	208, 240	2070	68 lbs.	5652

^M Recommended for use in a metallic countertop. For other surfaces, verify that the material is suitable for temperatures up to 200°F. Hatco is not responsible for counter damage caused by heat from the warmer.

All Glo-Ray Built-In Rectangular Recessed Top Aluminum Heated Shelf Models Feature:

Plugs: All models ending in -F and -I and models 24" through 48" wide ending in -O: NEMA 5-15P.

GRSB-60-O: NEMA 5-20P.

GRSB-72-O: NEMA 6-15P.

Usable Heated Shelf Space: Subtract 1 1/2" from both width and depth of unit.

Cord Location: Cord is attached to Control Box.

OPTIONS AND ACCESSORIES – PAGE 151

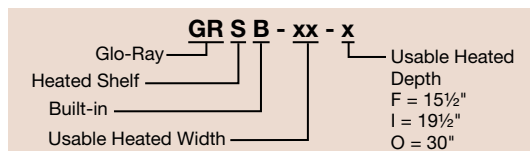

NOTE: Install Remote Box outside Heat Zone or damage will occur.



A **GRSB-54-I** Heated Shelf below a **GRAL-96D** Strip Heater

OPTIONS (available at time of purchase only)

Designer Color Bezel (Flush Mount Control Box, Bezel only) – Stainless Steel standard		\$ 69
Non-standard colors are non-returnable –		
RED	Warm Red	
WHITE	White Granite	
COPPER	Antique Copper	
BLACK	Black	
NAVY	Navy Blue	
GRAY	Gray Granite	
GREEN	Hunter Green	
GRSB-FLUSH-ITC	Flush Mount recessed Electronic Control Box with lighted On/Off rocker switch and angled recessed controls (6 ¹³ / ₃₂ "W x 7 ¹³ / ₁₆ "H x 4 ¹³ / ₁₆ "D)	296
GRSB-FLUSH-TSTAT	Flush Mount recessed Thermostatic Control Box with lighted On/Off rocker switch and angled recessed controls (6 ¹³ / ₃₂ "W x 7 ¹³ / ₁₆ "H x 4 ¹ / ₈ "D) ▼	No Charge
COND-6	6' Conduit (3' standard) – used with Flush Mount ITC Control Boxes only	\$ 67
COND-10	10' Conduit (3' standard) – used with Flush Mount ITC Control Boxes only	132

ACCESSORIES (available for purchase at any time)

Stainless Steel Channel Dividers for GRSB models – Required to keep Rods in place – includes front and back Dividers –

GRSB-CD-24	For GRSB-24 models	\$ 88
GRSB-CD-30	For GRSB-30 models	117
GRSB-CD-36	For GRSB-36 models	147
GRSB-CD-42	For GRSB-42 models	174
GRSB-CD-48	For GRSB-48 models	205
GRSB-CD-54	For GRSB-54 models	236
GRSB-CD-60	For GRSB-60 models	263
GRSB-CD-66	For GRSB-66 models	295
GRSB-CD-72	For GRSB-72 models	324

Stainless Steel Rods – sold individually –

GRSB-DIV-F	For F depth units	each \$40
GRSB-DIV-I	For I depth units	each 43
GRSB-DIV-O	For O depth units	each 51

▼ See page 64 for Control Box cutout dimensions

FOOD PANS AND TRIVETS – PAGE 240

COLORS AND FINISHES – PAGE 241



GRSB-FLUSH-ITC



GRSB-FLUSH-TSTAT

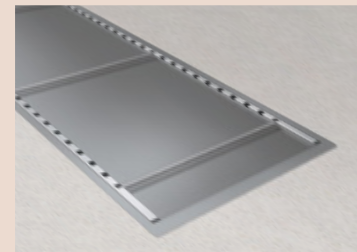

GRSB-72-I with Channel Dividers (vertical, with notches) and Rods (horizontal)

NOTE: Install Remote Box outside Heat Zone or damage will occur.



Glo-Ray® Built-In Rectangular Flush Top Aluminum Heated Shelves

Add heat to your serving surface with the Glo-Ray Rectangular Heated Shelf Built-In with Flush Top. The Hardcoat Aluminum surface and blanket-type element provides uniform heat to extend your food holding time.

- Uniform heat distribution with Hardcoat Aluminum surface and blanket-type element
- Includes Control Box with 3' conduit and 6' cord and plug
- Thermostatically-controlled heated base
- Standard controller includes control thermostat, illuminated power switch and mounting brackets
- Model widths from 25½" to 73½"
- Optional Stainless Steel surface
- For use in countertops up to 1¼" thick



GRSBF-60-0 built into a Bermuda Sand simulated stone countertop with accessory pans, shown below a GR2AL-96D Strip Heater in Designer Black with optional Sneeze Guards

Quick-Ship Program Information *Inside Back Cover*

GLO-RAY BUILT-IN RECTANGULAR FLUSH TOP ALUMINUM HEATED SHELVES

Model ^M	Dimensions W x D x H	Cut-Out Dimensions		Voltage Single Phase	Watts	Approx. Ship Weight	List Price
		Min.-Max. Width	Min.-Max. Depth				
GRSBF-24-F	25½" x 17" x 2¼"	24½"-24¾"	16"-16¼"	120	420	28 lbs.	\$2726
GRSBF-24-I	25½" x 21" x 2¼"	24½"-24¾"	20"-20¼"	120	550	27 lbs.	2737
GRSBF-24-S	25½" x 25½" x 2¼"	24½"-24¾"	24½"-24¾"	120	680	32 lbs.	2899
GRSBF-24-O	25½" x 31½" x 2¼"	24½"-24¾"	30½"-30¾"	120	790	35 lbs.	2972
GRSBF-30-F	31½" x 17" x 2¼"	30½"-30¾"	16"-16¼"	120	505	24 lbs.	2904
GRSBF-30-I	31½" x 21" x 2¼"	30½"-30¾"	20"-20¼"	120	665	30 lbs.	2916
GRSBF-30-S	31½" x 25½" x 2¼"	30½"-30¾"	24½"-24¾"	120	815	33 lbs.	3140
GRSBF-30-O	31½" x 31½" x 2¼"	30½"-30¾"	30½"-30¾"	120	950	37 lbs.	3236
GRSBF-36-F	37½" x 17" x 2¼"	36½"-36¾"	16"-16¼"	120	590	32 lbs.	3087
GRSBF-36-I	37½" x 21" x 2¼"	36½"-36¾"	20"-20¼"	120	780	30 lbs.	3101
GRSBF-36-S	37½" x 25½" x 2¼"	36½"-36¾"	24½"-24¾"	120	950	35 lbs.	3496
GRSBF-36-O	37½" x 31½" x 2¼"	36½"-36¾"	30½"-30¾"	120	1110	37 lbs.	3602
GRSBF-42-F	43½" x 17" x 2¼"	42½"-42¾"	16"-16¼"	120	685	38 lbs.	3240
GRSBF-42-I	43½" x 21" x 2¼"	42½"-42¾"	20"-20¼"	120	885	32 lbs.	3256
GRSBF-42-S	43½" x 25½" x 2¼"	42½"-42¾"	24½"-24¾"	120	1090	40 lbs.	3829
GRSBF-42-O	43½" x 31½" x 2¼"	42½"-42¾"	30½"-30¾"	120	1270	48 lbs.	3956
GRSBF-48-F	49½" x 17" x 2¼"	48½"-48¾"	16"-16¼"	120	770	35 lbs.	3413
GRSBF-48-I	49½" x 21" x 2¼"	48½"-48¾"	20"-20¼"	120	1000	40 lbs.	3430
GRSBF-48-S	49½" x 25½" x 2¼"	48½"-48¾"	24½"-24¾"	120	1225	42 lbs.	4120
GRSBF-48-O	49½" x 31½" x 2¼"	48½"-48¾"	30½"-30¾"	120	1430	48 lbs.	4263
GRSBF-54-I	55½" x 21" x 2¼"	54½"-54¾"	20"-20¼"	120	1110	41 lbs.	3602
GRSBF-60-F	61½" x 17" x 2¼"	60½"-60¾"	16"-16¼"	120	950	41 lbs.	3766
GRSBF-60-I	61½" x 21" x 2¼"	60½"-60¾"	20"-20¼"	120	1220	48 lbs.	3782
GRSBF-60-S	61½" x 25½" x 2¼"	60½"-60¾"	24½"-24¾"	120	1500	55 lbs.	4820
GRSBF-60-O	61½" x 31½" x 2¼"	60½"-60¾"	30½"-30¾"	120	1750	64 lbs.	4955
GRSBF-66-I	67½" x 21" x 2¼"	66½"-66¾"	20"-20¼"	120	1330	49 lbs.	3933
GRSBF-72-F	73½" x 17" x 2¼"	72½"-72¾"	16"-16¼"	120	1130	44 lbs.	4069
GRSBF-72-I	73½" x 21" x 2¼"	72½"-72¾"	20"-20¼"	120	1440	52 lbs.	4087
GRSBF-72-S	73½" x 25½" x 2¼"	72½"-72¾"	24½"-24¾"	120	1750	59 lbs.	5430
GRSBF-72-O	73½" x 31½" x 2¼"	72½"-72¾"	30½"-30¾"	208, 240	2070	68 lbs.	5652

^M Recommended for use in a metallic countertop. For other surfaces, verify the material is suitable for temperatures up to 200°F. Hatco is not responsible for counter damage caused by heat from the warmer.

All Glo-Ray Built-In Rectangular Flush Top Aluminum Heated Shelf Models Feature:

Plugs: All models ending in -F and -I and models 24" through 48" wide ending in -S and -O: NEMA 5-15P.

GRSBF-60-S, GRSBF-60-O and GRSBF-72-S: NEMA 5-20P. GRSBF-72-O: NEMA 6-15P.

Usable Heated Shelf Space: Width of unit minus 1½" x depth of unit minus 1½". Cord Location: Cord is attached to Control Box.



Standard Control Box

NOTE: For any size GRSBF, the next larger size GRA or GR2A Strip Heater will fit over the top. For example, a GRSBF-30 will require a GRA-36 or GR2A-36. The GRA will have a tight fit to the frame of the base. The GR2A will have approx a 4" space.

NOTE: Install Remote Box outside Heat Zone or damage will occur.



GRSBF-FLUSH-ITC



GRSBF-FLUSH-TSTAT

OPTIONS (available at time of purchase only)

Designer Color Bezel (Flush Mount Control Box, Bezel only) – Stainless Steel standard – Non-standard colors are non-returnable – \$69

	RED Warm Red	WHITE White Granite	BLACK Black	NAVY Navy Blue	
	GRAY Gray Granite	GREEN Hunter Green	COPPER Antique Copper		
GRSBF-SS	Stainless Steel surface in lieu of Hardcoat Aluminum (GRSBF models only)				No Charge
GRSBF-FLUSH-ITC	Flush Mount recessed Electronic Control Box with lighted On/Off rocker switch and angled recessed controls (6 ¹³ / ₃₂ "W x 7 ¹³ / ₁₆ "H x 4 ¹³ / ₁₆ "D)▼				\$296
GRSBF-FLUSH-TSTAT	Flush Mount recessed Thermostatic Control Box with lighted On/Off rocker switch and angled recessed controls (6 ¹³ / ₃₂ "W x 7 ¹³ / ₁₆ "H x 4 ¹³ / ₁₆ "D)▼				No Charge
COND-6	6' Conduit (3' standard) – used with Flush Mount ITC Control Boxes only				\$ 67
COND-10	10' Conduit (3' standard) – used with Flush Mount ITC Control Boxes only				132

▼ See page 64 for Control Box cutout dimensions

FOOD PANS AND TRIVETS – PAGE 240

COLORS AND FINISHES – PAGE 241

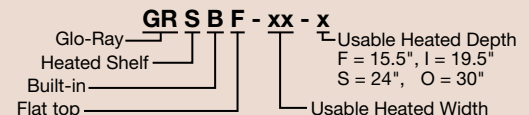



Remote Hot/Cold Built-In Simulated Stone Shelves

Give your operation ultimate flexibility with Hatco's innovative, Remote Hot/Cold Built-In Simulated Stone Shelves. They easily transition between a heated to cold and cold to heated shelf!

- Patented thermal break reduces condensation and temperature transfer on adjacent surfaces
- Shelves change modes from hot to cold or vice versa in as little as 30 minutes, allowing quick change for different dayparts
- All models are bottom mount, flush with the countertop
- Simulated stone is Swanstone® and Dekton®
- All models match the GRSSB Heated Built-In Shelves
- Control Box with a 4' lead wire is standard
- Condensing unit features easy serviceability with sight glass, service valves, dryer/filter and receiver (HCSSBR models only)
- HCSSBR has unattached Condensing unit and Control Box, HCSSBX has unattached Control Box only



HCSSBR-4818
with optional Domoos surface by Dekton®



HCSSBX-4818
with optional Rem surface by Dekton®

HOT/COLD BUILT-IN SIMULATED STONE SHELVES (flush to countertop) with UNATTACHED CONDENSER/CONTROL BOX

Model	Overall Shelf Dimensions (includes brackets) W x D	Shelf Space W x D	Volts Single Phase	Cold Side Watts	Hot Side Watts	Hz	Comp. Size HP	Approx. Ship Weight	List Price
HCSSBR-2418	27" x 21"	24" x 18"	120	300	405	60	1/5	115 lbs.	\$13029
HCSSBR-3018	33" x 21"	30" x 18"	120	300	510	60	1/5	151 lbs.	13175
HCSSBR-3618	39" x 21"	36" x 18"	120	300	610	60	1/5	162 lbs.	13441
HCSSBR-4818	51" x 21"	48" x 18"	120	450	815	60	1/3	187 lbs.	14960

All Hot/Cold Built-In Simulated Stone Shelf Models with Unattached Condenser/Control Box Feature:
Models Shipped with: Shelf assembly with temperature probe, Control Box, condensing unit and TXV (all shipped loose).

Dekton® stone surfaces that are available for these models:

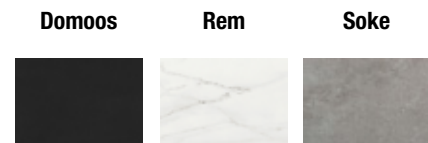

Note: Due to the natural texture, patterns may vary.

HOT/COLD BUILT-IN SIMULATED STONE SHELVES (flush to countertop) with UNATTACHED CONTROL BOX only

Model	Overall Shelf Dimensions (includes brackets) W x D	Shelf Space W x D	Watts 120V Single Phase	Approx. Ship Weight	List Price
HCSSBX-2418	27" x 21"	24" x 18"	405	75 lbs.	\$11280
HCSSBX-3018	33" x 21"	30" x 18"	510	105 lbs.	11427
HCSSBX-3618	39" x 21"	36" x 18"	610	117 lbs.	11691
HCSSBX-4818	51" x 21"	48" x 18"	815	140 lbs.	13211

All Hot/Cold Built-In Simulated Stone Shelf Models with unattached Control Box Only Feature:
Models Shipped with: Shelf assembly with temperature probe, solenoid valve (attached to shelf), Control Box (shipped loose) and TXV (unattached).

COUNTERTOP CUTOUT DIMENSIONS

Model	Width with 3/8" radii	Height with 3/8" radii
HCSSB(R)(X)-2418	24 3/8"	18 3/8"
HCSSB(R)(X)-3018	30 3/8"	18 3/8"
HCSSB(R)(X)-3618	36 3/8"	18 3/8"
HCSSB(R)(X)-4818	48 3/8"	18 3/8"
Model	Width	Height
Control Box	14 5/8"	7 3/4"

NOTE: Install Remote Box outside Heat Zone or damage will occur.

OPTIONS AND ACCESSORIES – PAGE 70

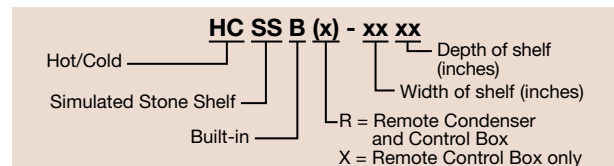



Remote Hot/Cold Built-In Simulated Stone Shelves

continued...



HCSSBR-4818
with optional white
glass-ceramic top
surface



HCSSBX-4818
with optional black
glass-ceramic top
surface

OPTIONS

(available at time of purchase only)

Simulated stone colors – Non-standard colors are non-returnable – Night Sky standard –

SS-GGRAN	Gray Granite	No Charge
SS-BSAND	Bermuda Sand	No Charge

Glass Ceramic colors – All Glass Ceramic colors are non-returnable

BLACKGLASS	Black Glass-Ceramic Top	No Charge
WHITEGLASS	White Glass-Ceramic Top	No Charge
EWC	Additional four year extended Parts Only Warranty on the compressor available at the time of unit purchase (HCSSB, HCSSBR models only)	\$275

Dekton® Stone Colors – All Dekton surfaces are non-returnable –

For HCSSBR-2418 and HCSSBX-2418 models –

DOMOOS	Domoos	\$1001
REM	Rem	1001
SOKE	Soke	1001

For HCSSBR-3018 and HCSSBX-3018 models –

DOMOOS	Domoos	\$1391
REM	Rem	1391
SOKE	Soke	1391

For HCSSBR-3618 and HCSSBX-3618 models –

DOMOOS	Domoos	\$1610
REM	Rem	1610
SOKE	Soke	1610

For HCSSBR-4818 and HCSSBX-4818 models –

DOMOOS	Domoos	\$1702
REM	Rem	1702
SOKE	Soke	1702

COLORS AND FINISHES – PAGE 241





Remote Hot/Cold Built-In Flush Top Simulated Stone Shelves

Give your operation ultimate flexibility with Hatco's innovative, Remote Hot/Cold Built-In Flush Top Simulated Stone Shelves. They easily transition between a heated to cold and cold to heated shelf!

- Patented thermal break reduces condensation and temperature transfer on adjacent surfaces
- Shelves change modes from hot to cold or vice versa in as little as 30 minutes, allowing quick changes for different dayparts
- All units are bottom mount, flush with the countertop
- Simulated stone is Swanstone®
- Control Box comes standard with a 4' lead wire
- Condensing unit features easy serviceability with sight glass, service valves, dryer/filter and receiver (HCSSBFR models only)
- HCSSBFR has unattached Condensing unit and Control Box, HCSSBFX has unattached Control Box only
- HCSSBFR and HCSSBFX models have benefit of allowing fabricators the freedom to design



HCSSBFR-48-S
in optional Granite Gray simulated stone – All models include unattached Condenser and Control Box only

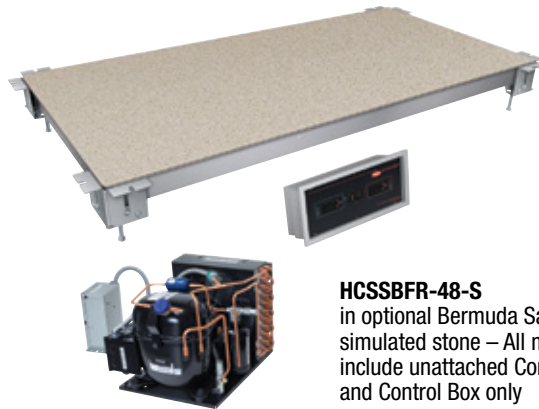

HCSSBFR-48-S
in optional Bermuda Sand simulated stone – All models include unattached Condenser and Control Box only

HOT/COLD BUILT-IN FLUSH TOP SIMULATED STONE SHELVES with UNATTACHED CONDENSER/CONTROL BOX

Model	Overall Shelf Dimensions (includes brackets) W x D	Shelf Space W x D	Voltage Single Phase	Cold Side Watts	Hot Side Watts	Hz	Comp. Size HP	Approx. Ship Weight	List Price
HCSSBFR-24-F	27" x 18½"	24" X 15½"	120	300	355	60	1/5	118 lbs.	\$12937
HCSSBFR-24-I	27" x 22½"	24" X 19½"	120	300	445	60	1/5	117 lbs.	13029
HCSSBFR-24-S	27" x 27"	24" X 24"	120	300	550	60	1/5	107 lbs.	13163
HCSSBFR-36-F	39" x 18½"	36" X 15½"	120	300	530	60	1/5	159 lbs.	13386
HCSSBFR-36-I	39" x 22½"	36" X 19½"	120	450	670	60	1/3	159 lbs.	13441
HCSSBFR-36-S	39" x 27"	36" X 24"	120	450	825	60	1/3	190 lbs.	15183
HCSSBFR-48-F	51" x 18½"	48" X 15½"	120	450	710	60	1/3	187 lbs.	13898
HCSSBFR-48-I	51" x 22½"	48" X 19½"	120	450	890	60	1/3	206 lbs.	15051
HCSSBFR-48-S	51" x 27"	48" X 24"	120	800	1100	60	5/8	218 lbs.	18409

All Hot/Cold Built-In Flush Top Simulated Stone Shelf Models with Unattached Condenser/Control Box Feature: Models Shipped with: Shelf assembly with temperature probe, Control Box, condensing unit and TXV (all shipped loose).

OPTIONS – PAGE 72

COUNTERTOP CUTOUT DIMENSIONS

Model	Width with 3/8" radii	Height with 3/8" radii
HCSSBF(R)(X)-24-F	24 3/8"	15 7/8"
HCSSBF(R)(X)-24-I	24 3/8"	19 7/8"
HCSSBF(R)(X)-24-S	24 3/8"	24 3/8"
HCSSBF(R)(X)-36-F	36 1/4"	15 7/8"
HCSSBF(R)(X)-36-I	36 1/4"	19 7/8"
HCSSBF(R)(X)-36-S	36 1/4"	24 3/8"
HCSSBF(R)(X)-48-F	48 1/4"	15 7/8"
HCSSBF(R)(X)-48-I	48 1/4"	19 7/8"
HCSSBF(R)(X)-48-S	48 1/4"	24 3/8"
Model	Width	Height
Control Box	14 5/8"	7 3/4"



NOTE: Install Remote Box outside Heat Zone or damage will occur.

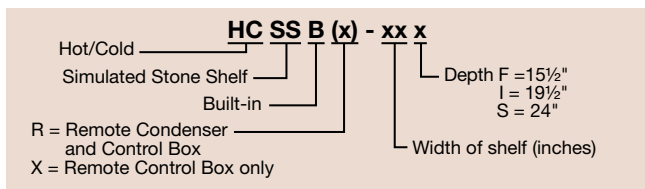



Hot/Cold Built-In Flush Top Simulated Stone Shelves

continued...



HCSSBFX-48-S
in optional Bermuda Sand
simulated stone – All models
include unattached Control
Box only



HCSSBFX-48-S
in standard Night Sky
simulated stone – All models
include unattached Control
Box only

HOT/COLD BUILT-IN FLUSH TOP SIMULATED STONE SHELVES with UNATTACHED CONTROL BOX only

Model	Overall Shelf Dimensions (includes brackets) W x D	Shelf Space W x D	Watts 120V Single Phase	Approx. Ship Weight	List Price
HCSSBFX-24-F	27" x 18½"	24" x 15½"	355	92 lbs.	\$11189
HCSSBFX-24-I	27" x 22½"	24" x 19½"	445	97 lbs.	11280
HCSSBFX-24-S	27" x 27"	24" x 24"	550	105 lbs.	11413
HCSSBFX-36-F	39" x 18½"	36" x 15½"	530	114 lbs.	11636
HCSSBFX-36-I	39" x 22½"	36" x 19½"	670	122 lbs.	11691
HCSSBFX-36-S	39" x 27"	36" x 24"	825	153 lbs.	13434
HCSSBFX-48-F	51" x 18½"	48" x 15½"	710	130 lbs.	12149
HCSSBFX-48-I	51" x 22½"	48" x 19½"	890	150 lbs.	13303
HCSSBFX-48-S	51" x 27"	48" x 24"	1100	167 lbs.	16661

All Hot/Cold Built-In Flush Top Simulated Stone Shelf Models with Unattached Control Box Only Feature:
Models Shipped with: Shelf assembly with temperature probe, solenoid valve (attached to shelf),
Control Box (shipped loose) and TXV (unattached).

OPTIONS (available at time of purchase only)

Simulated stone colors – Non-standard colors are non-returnable –
Night Sky standard –

SS-GGRAN	Gray Granite	No Charge
SS-BSAND	Bermuda Sand	No Charge
EWC	Additional four year extended Parts Only Warranty on the compressor available at the time of unit purchase (HCSSBF, HCSSBFR models only)	\$275

COLORS AND FINISHES – PAGE 241



Remote Hot/Cold Built-In Flush Top Shelves

Give your operation ultimate flexibility with Hatco's innovative, Remote Hot/Cold Built-In Flush Top Shelves. In our signature Hardcoat Aluminum, they easily transition between a heated to cold and cold to heated shelf!

- Patented thermal break reduces condensation and temperature transfer on adjacent surfaces
- Shelves change modes from hot to cold or vice versa in as little as 30 minutes, allowing quick change for different dayparts
- Units are Hardcoat Aluminum, top mount
- All models match the GRSBF Heated Built-In Shelves for a fully integrated look
- Control Box with a 4' lead wire is standard
- Condensing unit features easy serviceability with sight glass, service valves, dryer/filter and receiver (HCSBFR models only)
- HCSBFR models have unattached Condensing unit and Control Box, HCSBFX models have unattached Control Box only
- HCSBFR and HCSBFX models have benefit of allowing fabricators the freedom to design.



HCSBFR-48-S All models include unattached Condenser and Control Box only

HOT/COLD BUILT-IN FLUSH TOP SHELVES (Hardcoat Aluminum) with UNATTACHED CONDENSER/CONTROL BOX

Model	Overall Shelf Dimensions W x D	Usable Shelf Space W x D	Voltage Single Phase	Cold Side Watts	Hot Side Watts	Hz	Comp. Size HP	Approx. Ship Weight	List Price
HCSBFR-24-F	25½" x 17"	24" x 15½"	120	300	355	60	1/5	106 lbs.	\$12782
HCSBFR-24-I	25½" x 21"	24" x 19½"	120	300	455	60	1/5	118 lbs.	13107
HCSBFR-24-S	25½" x 25½"	24" x 24"	120	300	550	60	1/5	132 lbs.	13433
HCSBFR-36-F	37½" x 17"	36" x 15½"	120	300	530	60	1/5	147 lbs.	13490
HCSBFR-36-I	37½" x 21"	36" x 19½"	120	450	670	60	1/3	133 lbs.	13658
HCSBFR-36-S	37½" x 25½"	36" x 24"	120	450	825	60	1/3	156 lbs.	15025
HCSBFR-48-F	49½" x 17"	48" x 15½"	120	450	710	60	1/3	145 lbs.	14906
HCSBFR-48-I	49½" x 21"	48" x 19½"	120	450	890	60	1/3	131 lbs.	15401
HCSBFR-48-S	49½" x 25½"	48" x 24"	120	800	1100	60	5/8	255 lbs.	16919

All Hot/Cold Built-In Flush Top Simulated Stone Shelf Models with Unattached Condenser/Control Box Feature: Models Shipped with: Shelf assembly with temperature probe, Control Box, condensing unit and TXV (all shipped loose).

OPTIONS – PAGE 147

COUNTERTOP CUTOUT DIMENSIONS

Model	Width		Height	
	Min	Max	Min	Max
HCSBF(R)(X)-24-F	24 ⁵ / ₈ "	25"	16 ¹ / ₈ "	16 ¹ / ₂ "
HCSBF(R)(X)-24-I	24 ⁵ / ₈ "	25"	20 ¹ / ₈ "	20 ¹ / ₂ "
HCSBF(R)(X)-24-S	24 ⁵ / ₈ "	25"	24 ³ / ₄ "	25"
HCSBF(R)(X)-36-F	36 ⁵ / ₈ "	37"	16 ¹ / ₈ "	16 ¹ / ₂ "
HCSBF(R)(X)-36-I	36 ⁵ / ₈ "	37"	20 ¹ / ₈ "	20 ¹ / ₂ "
HCSBF(R)(X)-36-S	36 ⁵ / ₈ "	37"	24 ³ / ₄ "	25"
HCSBF(R)(X)-48-F	48 ⁵ / ₈ "	49"	16 ¹ / ₈ "	16 ¹ / ₂ "
HCSBF(R)(X)-48-I	48 ⁵ / ₈ "	49"	20 ¹ / ₈ "	20 ¹ / ₂ "
HCSBF(R)(X)-48-S	48 ⁵ / ₈ "	49"	24 ³ / ₄ "	25"
Model	Width		Height	
Control Box	14 ⁵ / ₈ "		7 ³ / ₈ "	



NOTE: Install Remote Box outside Heat Zone or damage will occur.

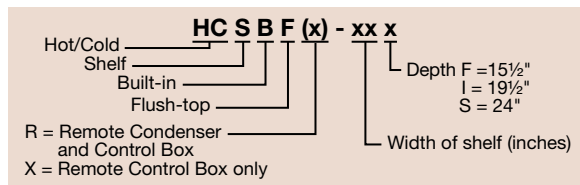



Remote Hot/Cold Built-In Flush Top Shelves

continued...



HCSBFX-48-S
All models include
unattached Control
Box only

HOT/COLD BUILT-IN FLUSH TOP SHELVES (Hardcoat Aluminum) with UNATTACHED CONTROL BOX only

Model	Overall Shelf Dimensions	Usable Shelf Space	Rated Watts	Approx. Ship Weight	List Price
	W x D	W x D	120V Single Phase		
HCSBFX-24-F	25½" x 17"	24" x 15½"	355	74 lbs.	\$10759
HCSBFX-24-I	25½" x 21"	24" x 19½"	445	84 lbs.	11083
HCSBFX-24-S	25½" x 25½"	24" x 24"	550	95 lbs.	11409
HCSBFX-36-F	37½" x 17"	36" x 15½"	530	105 lbs.	11467
HCSBFX-36-I	37½" x 21"	36" x 19½"	670	114 lbs.	11634
HCSBFX-36-S	37½" x 25½"	36" x 24"	825	116 lbs.	13001
HCSBFX-48-F	49½" x 17"	48" x 15½"	710	120 lbs.	12883
HCSBFX-48-I	49½" x 21"	48" x 19½"	890	131 lbs.	13377
HCSBFX-48-S	49½" x 25½"	48" x 24"	1100	139 lbs.	14894

All Hot/Cold Built-In Flush Top Simulated Stone Shelf Models with Unattached Control Box Only Feature:
Models Shipped with: Shelf assembly with temperature probe, solenoid valve (attached to shelf),
Control Box (shipped loose) and TXV (unattached).

OPTIONS (available at time of purchase only)

EWC Additional four year extended Parts Only Warranty on the compressor available at the time of unit purchase (HCSBF, HCSBFR models only) **\$275**

COLORS AND FINISHES – PAGE 241



R-290 Cold Built-In Simulated Stone Shelves

Hatco's R-290 Cold Simulated Stone Shelves Built-In are an environmentally friendly solution to keep food cold on buffet lines in cafeterias, restaurants and much more!

- Keeps food cold using environmentally friendly R-290 refrigerant
- Patented thermal break reduces condensation and temperature transfer on adjacent surfaces
- All models are bottom mount units
- Simulated stone is Swanstone®
- Control Box comes with standard 4' lead wire
- All models match the GRSSB Glo-Ray® Built-In Heated Simulated Stone Shelves
- Condenser utilizes an environmentally friendly R-290 refrigerant, which has a 90% higher heat absorption capacity than other refrigerants, resulting in quicker temperature recovery and lower energy consumption

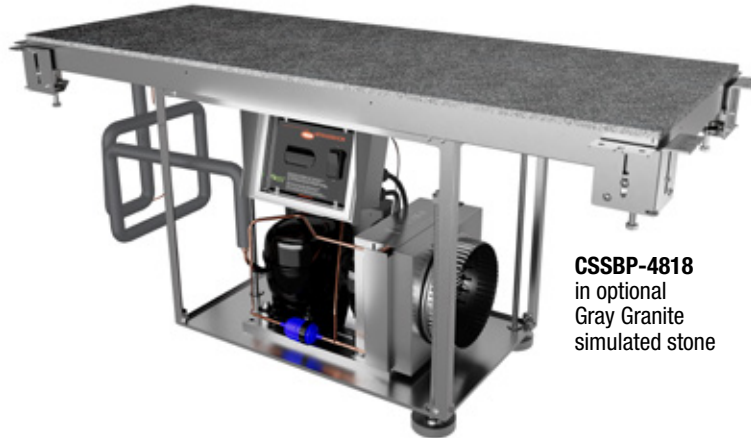

CSSBP-4818
in optional
Gray Granite
simulated stone

R-290 COLD BUILT-IN SIMULATED STONE SHELVES (flush to countertop)

Model	Overall Shelf Dimensions	Shelf Space	Voltage			Comp. Size	Approx. Ship Weight	List Price
	(includes brackets) W x D		W x D	Single Phase	Watts			
CSSBP-2418	27" x 21"	24" x 18"	120	345	60	1/5	126 lbs.	\$11869
CSSBP-3018	33" x 21"	30" x 18"	120	345	60	1/5	132 lbs.	12358
CSSBP-3618	39" x 21"	36" x 18"	120	345	60	1/5	145 lbs.	12558
CSSBP-4818	51" x 21"	48" x 18"	120	440	60	1/3	172 lbs.	14431

All R-290 Cold Built-In Simulated Stone Shelf Models Feature:

Models Shipped with: Electronic Temperature Control and a condensing unit, 6' cord and plug (NEMA 5-15P).

OPTIONS

(available at time of purchase only)

Simulated stone colors –

Non-standard colors are non-returnable – Night Sky standard –

SS-GGRAN Gray Granite	No Charge
SS-BSAND Bermuda Sand	No Charge

COLORS AND FINISHES – PAGE 241

COUNTERTOP CUTOUT DIMENSIONS

Model	Width with 3/8" corner radii	Depth with 3/8" corner radii
CSSBP-2418	24 3/8"	18 3/8"
CSSBP-3018	30 3/8"	18 3/8"
CSSBP-3618	36 3/8"	18 3/8"
CSSBP-4818	48 3/8"	18 3/8"

NOTE: The installation kit, including the intake bracket, duct clamp, flexible duct, and duct collar, will be shipped separately.

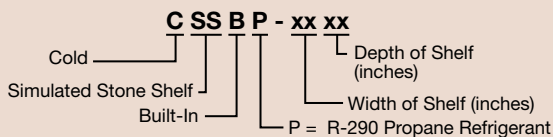



R-290 Cold Built-In Flush Top Simulated Stone Shelves

Hatco's R-290 Cold Built-In Flush Top Simulated Stone Shelves are a must for buffet lines in cafeterias, restaurants and more!

- Condenser utilizes environmentally friendly R-290 refrigerant
- Patented thermal break reduces condensation and temperature transfer on adjacent surfaces
- All models are bottom mount units
- Control Box can be mounted 4' from center of the shelf
- Simulated stone is Swanstone®

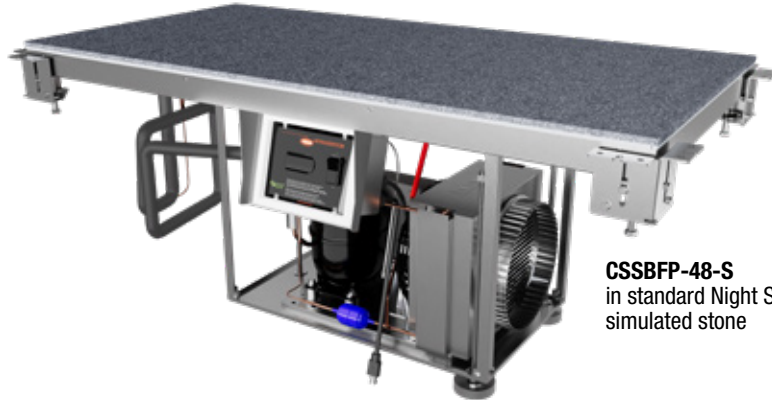

CSSBFP-48-S
in standard Night Sky simulated stone

R-290 COLD BUILT-IN FLUSH TOP SIMULATED STONE SHELVES

Model	Overall Shelf Dimensions (includes brackets) W x D	Shelf Space W x D	Voltage Single Phase	Watts	Hz	Comp. Size HP	Approx. Ship Weight	List Price
CSSBFP-24-F	27" x 18½"	24" x 15½"	120	345	60	1/5	119 lbs.	\$11307
CSSBFP-24-I	27" x 22½"	24" x 19½"	120	345	60	1/5	124 lbs.	12085
CSSBFP-24-S	27" x 27"	24" x 24"	120	345	60	1/5	134 lbs.	13190
CSSBFP-36-F	39" x 18½"	36" x 15½"	120	345	60	1/5	138 lbs.	12307
CSSBFP-36-I	39" x 22½"	36" x 19½"	120	440	60	1/3	155 lbs.	13131
CSSBFP-36-S	39" x 27"	36" x 24"	120	440	60	1/3	164 lbs.	14613
CSSBFP-48-F	51" x 18½"	48" x 15½"	120	440	60	1/3	159 lbs.	13329
CSSBFP-48-I	51" x 22½"	48" x 19½"	120	440	60	1/3	171 lbs.	14293
CSSBFP-48-S	51" x 27"	48" x 24"	120	560	60	1/2	189 lbs.	17328

All Cold Built-In Flush Top Simulated Stone Shelf Models Feature:

Electronic Temperature Control and a condensing unit, 6' cord and plug (NEMA 5-15P).

OPTIONS (available at time of purchase only)

Simulated stone colors – Non-standard colors are non-returnable – Night Sky standard –

SS-GGRAN	Gray Granite	No Charge
SS-BSAND	Bermuda Sand	No Charge
EWC	(Additional four year extended Parts Only Warranty on the compressor available at the time of unit purchase CSSB, CSSBR models only)	\$275

COLORS AND FINISHES – PAGE 241

COUNTERTOP CUTOUT DIMENSIONS

Model	Width with ⅜" corner radii	Depth with ⅜" corner radii
CSSBFP-24-F	24 ⅜"	15 ⅞"
CSSBFP-24-I	24 ⅜"	19 ⅞"
CSSBFP-24-S	24 ⅜"	24 ⅜"
CSSBFP-36-F	36 ⅜"	15 ⅞"
CSSBFP-36-I	36 ⅜"	19 ⅞"
CSSBFP-36-S	36 ⅜"	24 ⅜"
CSSBFP-48-F	48 ⅜"	15 ⅞"
CSSBFP-48-I	48 ⅜"	19 ⅞"
CSSBFP-48-S	48 ⅜"	24 ⅜"

NOTE: The installation kit, including the intake bracket, duct clamp, flexible duct, and duct collar, will be shipped separately.

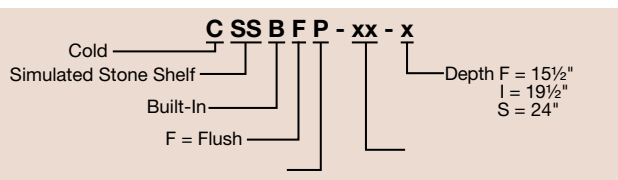



R-290 Cold Built-In Flush Top Shelves

Hatco's R-290 Cold Shelves Built-In Flush Top, in our signature Hardcoat Aluminum, are designed to keep your pre-chilled beverages, hors d'oeuvres, side dishes, buffet items and more, perfectly chilled.

- Condenser utilizes environmentally friendly R-290 refrigerant
- Patented thermal break reduces condensation and temperature transfer on adjacent surfaces
- All models are top mounted with an Hardcoat Aluminum surface
- All models match the GRSBF Heated Built-In Shelves for a fully integrated look
- Control Box comes standard with a 4' lead wire
- Condenser utilizes an environmentally friendly R-290 refrigerant, which has a 90% higher heat absorption capacity than other refrigerants, resulting in quicker temperature recovery and lower energy consumption



CSBFP-48-S
(Flush Top)

R-290 COLD BUILT-IN FLUSH TOP SHELVES (Hardcoat Aluminum)

Model	Overall Shelf Dimensions W x D	Usable Shelf Space W x D	Voltage		Comp. Size		Approx. Ship Weight	List Price
			Single Phase	Watts	HP	Hz		
CSBFP-24-F	25½" x 17"	24" x 15½"	120	345	1/5	60	108 lbs.	\$10230
CSBFP-24-I	25½" x 21"	24" x 19½"	120	345	1/5	60	116 lbs.	10660
CSBFP-24-S	25½" x 25½"	24" x 24"	120	345	1/5	60	117 lbs.	11095
CSBFP-36-F	37½" x 17"	36" x 15½"	120	345	1/5	60	130 lbs.	10939
CSBFP-36-I	37½" x 21"	36" x 19½"	120	440	1/3	60	130 lbs.	11793
CSBFP-36-S	37½" x 25½"	36" x 24"	120	440	1/3	60	151 lbs.	12377
CSBFP-48-F	49½" x 17"	48" x 15½"	120	440	1/3	60	138 lbs.	12101
CSBFP-48-I	49½" x 21"	48" x 19½"	120	440	1/3	60	157 lbs.	12686
CSBFP-48-S	49½" x 25½"	48" x 24"	120	560	1/2	60	177 lbs.	13719

All R-290 Cold Built-In Flush Top Shelf Models Feature:
Electronic Temperature Control and a condensing unit, 6' cord and plug (NEMA 5-15P).

COUNTERTOP CUTOUT DIMENSIONS

Model	Width		Depth	
	Min	Max	Min	Max
CSBFP-24-F	24 ⁵ / ₈ "	25"	16 ¹ / ₈ "	16½"
CSBFP-24-I	24 ⁵ / ₈ "	25"	20 ¹ / ₈ "	20½"
CSBFP-24-S	24 ⁵ / ₈ "	25"	24 ⁵ / ₈ "	25"
CSBFP-36-F	36 ⁵ / ₈ "	37"	16 ¹ / ₈ "	16½"
CSBFP-36-I	36 ⁵ / ₈ "	37"	20 ¹ / ₈ "	20½"
CSBFP-36-S	36 ⁵ / ₈ "	37"	24 ⁵ / ₈ "	25"
CSBFP-48-F	48 ⁵ / ₈ "	49"	16 ¹ / ₈ "	16½"
CSBFP-48-I	48 ⁵ / ₈ "	49"	20 ¹ / ₈ "	20½"
CSBFP-48-S	48 ⁵ / ₈ "	49"	24 ⁵ / ₈ "	25"

OPTIONS (available at time of purchase only)

EWC (Additional four year extended Parts Only Warranty on the compressor available at the time of unit purchase CSSB, CSSBR models only) **\$275**

NOTE: The installation kit, including the intake bracket, duct clamp, flexible duct, and duct collar, will be shipped separately.

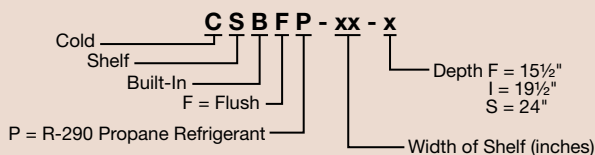

Heated & Cold Shelves



R-290 Cold Undermount Shelves

R-290 Cold Undermount Shelves use environmentally friendly R-290 refrigerant to provide a cold surface like the Cold Built-in Flush Top Shelves, but are mounted directly against the underside of a granite, quartz, Stainless Steel or appropriate solid surface countertop. Cooling transfers through the countertop with a seamless look.

- Condenser utilizes environmentally friendly R-290 refrigerant
- Mounts directly to underside of appropriate countertop material
- Condenser utilizes an environmentally friendly R-290 refrigerant, which has a 90% higher heat absorption capacity than other refrigerants, resulting in quicker temperature recovery and lower energy consumption
- Approved materials include granite and quartz up to 1 3/16", Swanstone® (provided by Hatco), and certain Stainless Steel or aluminum surfaces approved by Hatco. Please contact the factory for applications with other materials *
- All models feature an anodized aluminum surface
- Control Box comes standard with a 4' lead wire

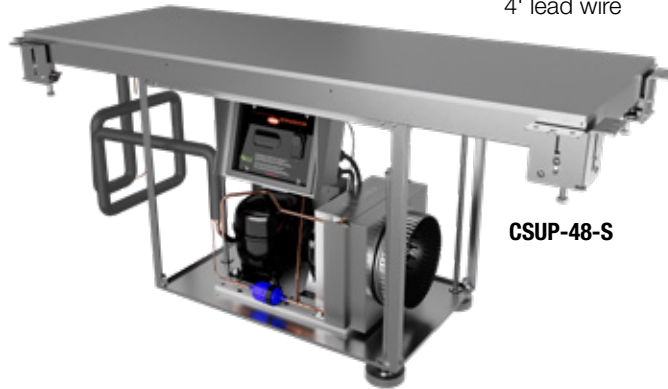

CSUP-48-S

R-290 COLD UNDERMOUNT SHELVES (Anodized Aluminum)

Model #	Overall Shelf Dimensions (includes brackets) W x D	Usable Shelf Space W x D	Watts 120V Single Phase	Hz	Compressor Size HP	Approx. Ship Weight	List Price
CSUP-24-F	27 5/16" x 18 13/16"	24" x 15 1/2"	345	60	1/5	115 lbs.	\$ 9972
CSUP-24-I	27 5/16" x 22 13/16"	24" x 19 1/2"	345	60	1/5	118 lbs.	10299
CSUP-24-S	27 5/16" x 27 5/16"	24" x 24"	345	60	1/5	130 lbs.	11077
CSUP-36-F	39 5/16" x 18 13/16"	36" x 15 1/2"	345	60	1/5	143 lbs.	10433
CSUP-36-I	39 5/16" x 22 13/16"	36" x 19 1/2"	440	60	1/3	140 lbs.	11074
CSUP-36-S	39 5/16" x 27 5/16"	36" x 24"	440	60	1/3	125 lbs.	11477
CSUP-48-F	51 5/16" x 18 13/16"	48" x 15 1/2"	440	60	1/3	141 lbs.	11296
CSUP-48-I	51 5/16" x 22 13/16"	48" x 19 1/2"	440	60	1/3	144 lbs.	11551
CSUP-48-S	51 5/16" x 27 5/16"	48" x 24"	560	60	1/2	178 lbs.	12707



CSUP models include thermal mastic caulk and a single use applicator

All Cold Undermount Shelf Models Feature:

Models Shipped with: Electronic Temperature Control and a condensing unit, 6' cord and plug (NEMA 5-15P), thermal mastic caulk and single use applicator.

OPTIONS (available at time of purchase only)

EWC (Additional four year extended Parts Only Warranty on the compressor available at the time of unit purchase CSSB, CSSBR models only) **\$275**

NOTE: The installation kit, including the intake bracket, duct clamp, flexible duct, and duct collar, will be shipped separately.

COUNTERTOP CUTOUT DIMENSIONS

Model	Width with 3/8" corner radii	Depth with 3/8" corner radii
CSUP-24-F	24 3/8"	15 7/8"
CSUP-24-I	24 3/8"	19 7/8"
CSUP-24-S	24 3/8"	24 3/8"
CSUP-36-F	36 3/8"	15 7/8"
CSUP-36-I	36 3/8"	19 7/8"
CSUP-36-S	36 3/8"	24 3/8"
CSUP-48-F	48 3/8"	15 7/8"
CSUP-48-I	48 3/8"	19 7/8"
CSUP-48-S	48 3/8"	24 3/8"

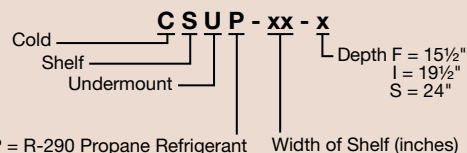



Remote Cold Built-In Simulated Stone Shelves

Hatco's Remote Cold Built-In Simulated Stone Shelves are a must for buffet lines in cafeterias, restaurants and much more!

The CSSBR and CSSBX models have benefit of allowing fabricators the freedom to design.

- Patented thermal break reduces condensation and temperature transfer on adjacent surfaces
- All models are bottom mount units
- Simulated stone is Swanstone®
- All models match the GRSSB Heated Simulated Stone Built-In Shelves for a fully integrated look
- Control Box comes with standard 4' lead wire

- Condensing unit features easy serviceability with sight glass, service valves, dryer/filter and receiver (CSSBR models only)
- CSSBR models have unattached Condensing unit and Control Box, CSSBX models have unattached Control Box only



CSSBR-4818
in standard Night Sky simulated stone – All models come with unattached Condenser and Control Box



CSSBX-4818
All models come with unattached Control Box only

COLD BUILT-IN SIMULATED STONE SHELVES with UNATTACHED CONDENSER/CONTROL BOX (flush to countertop)

Model	Overall Shelf Dimensions	Shelf Space	Voltage			Comp. Size	Approx. Ship Weight	List Price
	(includes brackets) W x D		W x D	Single Phase	Watts			
CSSBR-2418	27" x 21"	24" x 18"	120	300	60	1/5	88 lbs.	\$10997
CSSBR-3018	33" x 21"	30" x 18"	120	300	60	1/5	126 lbs.	11127
CSSBR-3618	39" x 21"	36" x 18"	120	300	60	1/5	139 lbs.	11522
CSSBR-4818	51" x 21"	48" x 18"	120	450	60	1/3	164 lbs.	13260

All Cold Built-In Simulated Stone Shelf Models with Unattached Condenser/Control Box Feature:
Models Shipped with: Shelf assembly with temperature probe, Control Box, condensing unit and TXV (all shipped loose).

COLD BUILT-IN SIMULATED STONE SHELVES with UNATTACHED CONTROL BOX only (flush to countertop)

Model	Overall Shelf Dimensions	Shelf Space	Watts		Approx. Ship Weight	List Price
	(includes brackets) W x D		W x D	120V Single Phase		
CSSBX-2418	27" x 21"	24" x 18"	12	60	75 lbs.	\$ 9248
CSSBX-3018	33" x 21"	30" x 18"	12	60	87 lbs.	9377
CSSBX-3618	39" x 21"	36" x 18"	12	60	99 lbs.	9773
CSSBX-4818	51" x 21"	48" x 18"	12	60	125 lbs.	11511

All Cold Built-In Simulated Stone Shelf Models with Unattached Control Box Only Feature:
Models Shipped with: Shelf assembly with temperature probe, solenoid valve (attached to shelf), Control Box (shipped loose) and TXV (unattached).

COUNTERTOP CUTOUT DIMENSIONS

Model	Width	Height
	with 3/8" radii	with 3/8" radii
CSSB(R)(X)-2418	24 3/8"	18 3/8"
CSSB(R)(X)-3018	30 3/8"	18 3/8"
CSSB(R)(X)-3618	36 3/8"	18 3/8"
CSSB(R)(X)-4818	48 3/8"	18 3/8"

Model	Width	Height
Control Box	9 1/2"	7 3/4"

OPTIONS

(available at time of purchase only)

Simulated stone colors – Non-standard colors are non-returnable – Night Sky standard –

SS-GGRAN	Gray Granite	No Charge
SS-BSAND	Bermuda Sand	No Charge

EWC (Additional four year extended Parts Only Warranty on the compressor available at the time of unit purchase CSSB, CSSBR models only)

\$275

COLORS AND FINISHES – PAGE 241

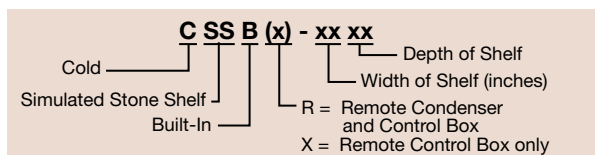



Remote Cold Built-In Flush Top Simulated Stone Shelves

Hatco's sturdy Remote Cold Built-In Flush Top Simulated Stone Shelves are a must for buffet lines in cafeterias, restaurants and more!

- Patented thermal break reduces condensation and temperature transfer on adjacent surfaces
- All models are bottom mount units
- Control Box comes standard with a 4' lead wire
- Condensing unit features easy serviceability with sight glass, service valves, dryer/filter and receiver (CSSBFR models only)

- Simulated stone is Swanstone®
- CSSBR models have unattached Condensing unit and Control Box, CSSBX models have unattached Control Box only
- CSSBFR, CSSBFX models have benefit of allowing fabricators the freedom to design



CSSBFR-48-S
in optional Bermuda Sand – All models come with unattached Condenser and Control Box



CSSBFX-48-S
in optional Gray Granite simulated stone – All models come with unattached Control Box only

COLD BUILT-IN FLUSH TOP SIMULATED STONE SHELVES TOP with UNATTACHED CONDENSER/CONTROL BOX

Model	Overall Shelf Dimensions (includes brackets) W x D	Shelf Space W x D	Voltage Single Phase	Watts	Hz	Comp. Size HP	Approx. Ship Weight	List Price
CSSBFR-24-F	27" x 18 1/2"	24" x 15 1/2"	120	300	60	1/5	120 lbs.	\$10977
CSSBFR-24-I	27" x 22 1/2"	24" x 19 1/2"	120	300	60	1/5	123 lbs.	11029
CSSBFR-24-S	27" x 27"	24" x 24"	120	300	60	1/5	150 lbs.	11428
CSSBFR-36-F	39" x 18 1/2"	36" x 15 1/2"	120	300	60	1/5	151 lbs.	11464
CSSBFR-36-I	39" x 22 1/2"	36" x 19 1/2"	120	450	60	1/3	151 lbs.	11517
CSSBFR-36-S	39" x 27"	36" x 24"	120	450	60	1/3	161 lbs.	13802
CSSBFR-48-F	51" x 18 1/2"	48" x 15 1/2"	120	450	60	1/3	158 lbs.	13204
CSSBFR-48-I	51" x 22 1/2"	48" x 19 1/2"	120	450	60	1/3	178 lbs.	13259
CSSBFR-48-S	51" x 27"	48" x 24"	120	800	60	5/8	166 lbs.	15791

All Cold Built-In Flush Top Simulated Stone Shelf Models with Unattached Condenser/Control Box Feature: Models Shipped with: Shelf assembly with temperature probe, Control Box, condensing unit and TXV (all shipped loose).

COLD BUILT-IN FLUSH TOP SIMULATED STONE SHELVES with UNATTACHED CONTROL BOX only

Model	Overall Shelf Dimensions (includes brackets) W x D	Shelf Space W x D	Watts 120V Single Phase	Hz	Approx. Ship Weight	List Price
CSSBFX-24-F	27" x 18 1/2"	24" x 15 1/2"	12	60	78 lbs.	\$ 9227
CSSBFX-24-I	27" x 22 1/2"	24" x 19 1/2"	12	60	79 lbs.	9280
CSSBFX-24-S	27" x 27"	24" x 24"	12	60	89 lbs.	9679
CSSBFX-36-F	39" x 18 1/2"	36" x 15 1/2"	12	60	97 lbs.	9715
CSSBFX-36-I	39" x 22 1/2"	36" x 19 1/2"	12	60	115 lbs.	9769
CSSBFX-36-S	39" x 27"	36" x 24"	12	60	117 lbs.	12054
CSSBFX-48-F	51" x 18 1/2"	48" x 15 1/2"	12	60	116 lbs.	11455
CSSBFX-48-I	51" x 22 1/2"	48" x 19 1/2"	12	60	130 lbs.	11510
CSSBFX-48-S	51" x 27"	48" x 24"	12	60	144 lbs.	14041

All Cold Built-In Flush Top Simulated Stone Shelf Models with Unattached Control Box Only Feature: Models Shipped with: Shelf assembly with temperature probe, solenoid valve (attached to shelf), Control Box (shipped loose) and TXV (unattached).

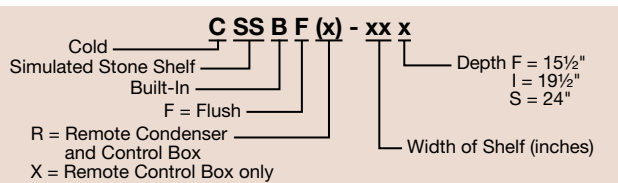

COUNTERTOP CUTOUT DIMENSIONS

Model	Width with 3/8" radii	Height with 3/8" radii
CSSBF(R)(X)-24-F	24 3/8"	15 7/8"
CSSBF(R)(X)-24-I	24 3/8"	19 7/8"
CSSBF(R)(X)-24-S	24 3/8"	24 3/4"
CSSBF(R)(X)-36-F	36 3/8"	15 7/8"
CSSBF(R)(X)-36-I	36 3/8"	19 7/8"
CSSBF(R)(X)-36-S	36 3/8"	24 3/4"
CSSBF(R)(X)-48-F	48 3/8"	15 7/8"
CSSBF(R)(X)-48-I	48 3/8"	19 7/8"
CSSBF(R)(X)-48-S	48 3/8"	24 3/4"

Model	Width	Height
Control Box	9 1/2"	7 3/4"

OPTIONS

(available at time of purchase only)

Simulated stone colors – Non-standard colors are non-returnable – Night Sky standard –

SS-GGRAN	Gray Granite	No Charge
SS-BSAND	Bermuda Sand	No Charge

EWC (Additional four year extended Parts Only Warranty on the compressor available at the time of unit purchase CSSBFR models only) **\$275**

COLORS AND FINISHES – PAGE 241





Remote Cold Built-In Flush Top Shelves

Hatco's Remote Cold Built-In Flush Top Shelves, in our signature Hardcoat Aluminum, are designed to keep your pre-chilled beverages, hors d'oeuvres, side dishes, buffet items and more, perfectly chilled.

- Patented thermal break reduces condensation and temperature transfer on adjacent surfaces
- All models are top mounted with an Hardcoat Aluminum surface
- All models match the GRSBF Heated Built-In Shelves for a fully integrated look
- Control Box comes standard with a 4' lead wire

- Condensing unit features easy serviceability with sight glass, service valves, dryer/filter and receiver (CSBFR models only)
- CSBFR models have unattached Condensing unit and Control Box, CSBFX models have unattached Control Box only
- CSBFR, CSBFX models have benefit of allowing fabricators the freedom to design



CSBFR-48-S
(Flush Top) All models come with unattached Condenser and Control Box



CSBFX-48-S
(Flush Top) All models come with unattached Control Box only

COLD BUILT-IN FLUSH TOP SHELVES (Hardcoat Aluminum) with UNATTACHED CONDENSER/CONTROL BOX

Model	Overall Shelf Dimensions W x D	Usable Shelf Space W x D	Voltage Single Phase	Watts	Comp. Size HP	Hz	Approx. Ship Weight	List Price
CSBFR-24-F	25½" x 17"	24" x 15½"	120	300	1/5	60	102 lbs.	\$10787
CSBFR-24-I	25½" x 21"	24" x 19½"	120	300	1/5	60	116 lbs.	10828
CSBFR-24-S	25½" x 25½"	24" x 24"	120	300	1/5	60	126 lbs.	10996
CSBFR-36-F	37½" x 17"	36" x 15½"	120	300	1/5	60	127 lbs.	11033
CSBFR-36-I	37½" x 21"	36" x 19½"	120	450	1/3	60	128 lbs.	11084
CSBFR-36-S	37½" x 25½"	36" x 24"	120	450	1/3	60	139 lbs.	12836
CSBFR-48-F	49½" x 17"	48" x 15½"	120	450	1/3	60	145 lbs.	12541
CSBFR-48-I	49½" x 21"	48" x 19½"	120	450	1/3	60	147 lbs.	12596
CSBFR-48-S	49½" x 25½"	48" x 24"	120	800	5/8	60	166 lbs.	14070

OPTIONS

(available at time of purchase only)

EWC	Additional four year extended Parts Only Warranty on the compressor available at the time of unit purchase (CSBF, CSBFR models only)	\$275
------------	--	--------------

COLORS AND FINISHES – PAGE 241

All Cold Built-In Flush Top Shelf With Unattached Condenser/Control Box Models Feature:

Models Shipped with: Shelf assembly with temperature probe, Control Box, condensing unit and TXV (all shipped loose).

COLD BUILT-IN FLUSH TOP SHELVES (Hardcoat Aluminum) with UNATTACHED CONTROL BOX only

Model	Overall Shelf Dimensions W x D	Usable Shelf Space W x D	Watts 120V Single Phase	Approx. Ship Weight	List Price
CSBFX-24-F	25½" x 17"	24" x 15½"	12	63 lbs.	\$ 8763
CSBFX-24-I	25½" x 21"	24" x 19½"	12	71 lbs.	8804
CSBFX-24-S	25½" x 25½"	24" x 24"	12	79 lbs.	8971
CSBFX-36-F	37½" x 17"	36" x 15½"	12	68 lbs.	9008
CSBFX-36-I	37½" x 21"	36" x 19½"	12	90 lbs.	9061
CSBFX-36-S	37½" x 25½"	36" x 24"	12	100 lbs.	10813
CSBFX-48-F	49½" x 17"	48" x 15½"	12	117 lbs.	10518
CSBFX-48-I	49½" x 21"	48" x 19½"	12	117 lbs.	10573
CSBFX-48-S	49½" x 25½"	48" x 24"	12	130 lbs.	12045

All Cold Built-In Flush Top Shelf Models with Unattached Control Box Only Feature:

Shelf assembly with temperature probe, solenoid valve (attached to shelf), Control Box (shipped loose) and TXV (unattached).

COUNTERTOP CUTOUT DIMENSIONS

Model	Width		Height	
	Min	Max	Min	Max
CSBF(R)(X)-24-F	24¾"	25"	16⅛"	16½"
CSBF(R)(X)-24-I	24¾"	25"	20⅛"	20½"
CSBF(R)(X)-24-S	24¾"	25"	24¾"	25"
CSBF(R)(X)-36-F	36¾"	37"	16⅛"	16½"
CSBF(R)(X)-36-I	36¾"	37"	20⅛"	20½"
CSBF(R)(X)-36-S	36¾"	37"	24¾"	25"
CSBF(R)(X)-48-F	48¾"	49"	16⅛"	16½"
CSBF(R)(X)-48-I	48¾"	49"	20⅛"	20½"
CSBF(R)(X)-48-S	48¾"	49"	24¾"	25"
Model	Width		Height	
Control Box	9½"		7¾"	

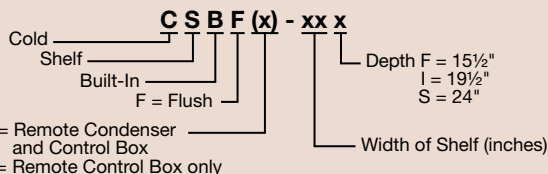



Remote Cold Undermount Shelves

Hatco's Remote Cold Undermount Shelves provide a cold surface like the Cold Built-in Flush Top Shelves, but are mounted directly against the underside of a granite, quartz, Stainless Steel or appropriate solid surface counter top. Cooling transfers through the countertop with a seamless look.

- Mounts directly to underside of appropriate countertop material
- Approved materials include granite and quartz up to 1 3/16", Swanstone® (provided by Hatco), and certain Stainless Steel or aluminum surfaces approved by Hatco. Please contact the factory for applications with other materials *
- All models feature an anodized aluminum surface
- Control Box comes standard with a 4' lead wire
- Condensing unit features easy serviceability with sight glass, service valves, dryer/filter and receiver (CSUR models only)
- CSUR models have unattached Condensing unit and Control Box, CSUX models have unattached Control Box only
- CSUR and CSUX models have benefit of allowing fabricators the freedom to design.

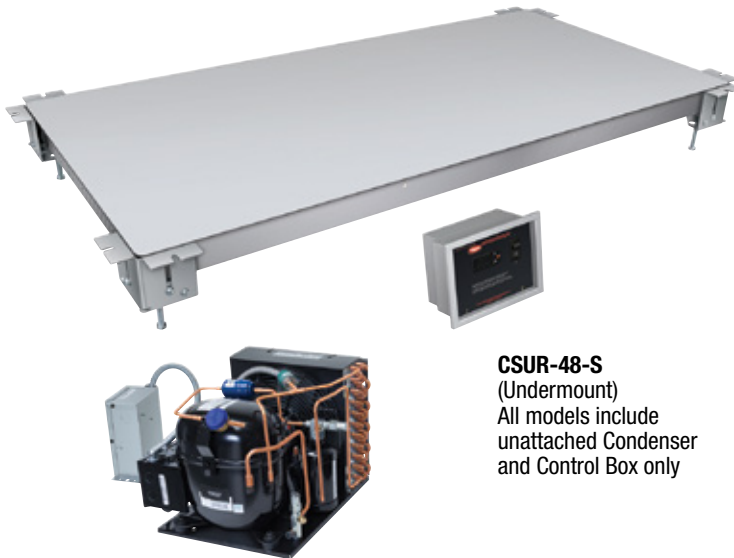

CSUR-48-S
(Undermount)
All models include unattached Condenser and Control Box only

COLD UNDERMOUNT SHELVES with UNATTACHED CONDENSER/CONTROL BOX (Anodized Aluminum)

Model #	Overall Shelf Dimensions (includes brackets) W x D	Shelf Space W x D	Watts 120V Single Phase	Hz	Compressor Size HP	Approx. Ship Weight	List Price
CSUR-24-F	27 ⁵ / ₁₆ " x 18 ¹³ / ₁₆ "	24" x 15 ¹ / ₂ "	300	60	1/5	110 lbs.	\$ 9807
CSUR-24-I	27 ⁵ / ₁₆ " x 22 ¹³ / ₁₆ "	24" x 19 ¹ / ₂ "	300	60	1/5	110 lbs.	9857
CSUR-24-S	27 ⁵ / ₁₆ " x 27 ¹³ / ₁₆ "	24" x 24"	300	60	1/5	119 lbs.	9970
CSUR-36-F	39 ⁵ / ₁₆ " x 18 ¹³ / ₁₆ "	36" x 15 ¹ / ₂ "	300	60	1/5	111 lbs.	9789
CSUR-36-I	39 ⁵ / ₁₆ " x 22 ¹³ / ₁₆ "	36" x 19 ¹ / ₂ "	450	60	1/3	118 lbs.	9809
CSUR-36-S	39 ⁵ / ₁₆ " x 27 ¹³ / ₁₆ "	36" x 24"	450	60	1/3	143 lbs.	11346
CSUR-48-F	51 ⁵ / ₁₆ " x 18 ¹³ / ₁₆ "	48" x 15 ¹ / ₂ "	450	60	1/3	150 lbs.	11029
CSUR-48-I	51 ⁵ / ₁₆ " x 22 ¹³ / ₁₆ "	48" x 19 ¹ / ₂ "	450	60	1/3	150 lbs.	11080
CSUR-48-S	51 ⁵ / ₁₆ " x 27 ¹³ / ₁₆ "	48" x 24"	800	60	5/8	150 lbs.	12186

All Cold Undermount Shelf Models with Unattached Condenser/Control Box Feature:
Models Shipped with: Shelf assembly with temperature probe, Control Box, condensing unit and TXV (all shipped loose), thermal mastic caulk and single use applicator.

Make structural modifications or add bracing underneath the countertop to ensure countertop will support the weight of the unit and its contents. For mounting bolt and substrate cutout dimensions, please refer to the Installation section in the Operating Manual which is found on the Hatco website, www.hatcocorp.com.



CSU and CSUR models include thermal mastic caulk and a single use applicator





Remote Cold Undermount Shelves

continued...



CSUX-48-S
(Undermount) All models include unattached Control Box only

COLD UNDERMOUNT SHELVES (Anodized Aluminum) with UNATTACHED CONTROL BOX only

Model [■]	Overall Shelf Dimensions (includes brackets) W x D	Shelf Space W x D	Watts 120V Single Phase	Approx. Ship Weight	List Price
CSUX-24-F	27 ⁵ / ₁₆ " x 18 ¹³ / ₁₆ "	24" x 15 ¹ / ₂ "	12	73 lbs.	\$ 8058
CSUX-24-I	27 ⁵ / ₁₆ " x 22 ¹³ / ₁₆ "	24" x 19 ¹ / ₂ "	12	75 lbs.	8109
CSUX-24-S	27 ⁵ / ₁₆ " x 27 ¹³ / ₁₆ "	24" x 24"	12	84 lbs.	8220
CSUX-36-F	39 ⁵ / ₁₆ " x 18 ¹³ / ₁₆ "	36" x 15 ¹ / ₂ "	12	91 lbs.	8040
CSUX-36-I	39 ⁵ / ₁₆ " x 22 ¹³ / ₁₆ "	36" x 19 ¹ / ₂ "	12	95 lbs.	8059
CSUX-36-S	39 ⁵ / ₁₆ " x 27 ¹³ / ₁₆ "	36" x 24"	12	99 lbs.	9596
CSUX-48-F	51 ⁵ / ₁₆ " x 18 ¹³ / ₁₆ "	48" x 15 ¹ / ₂ "	12	102 lbs.	9280
CSUX-48-I	51 ⁵ / ₁₆ " x 22 ¹³ / ₁₆ "	48" x 19 ¹ / ₂ "	12	113 lbs.	9332
CSUX-48-S	51 ⁵ / ₁₆ " x 27 ¹³ / ₁₆ "	48" x 24"	12	124 lbs.	10438

CUTOUT DIMENSIONS

Model	Width	Height
Control Box	9 ¹ / ₂ "	7 ³ / ₄ "

All Cold Undermount Shelf Models with Unattached Control Box only Feature:

Models Shipped with: Shelf assembly with temperature probe, solenoid valve (attached to shelf), Control Box (shipped loose) and TXV (unattached).

- Make structural modifications or add bracing underneath the countertop to ensure countertop will support the weight of the unit and its contents. For mounting bolt and substrate cutout dimensions, please refer to the Installation section in the Operating Manual which is found on the Hatco website, www.hatcocorp.com.

OPTIONS (available at time of purchase only)

EWC Additional four year extended Parts Only Warranty on the compressor available at the time of unit purchase (CSU, CSUR models only) **\$275**

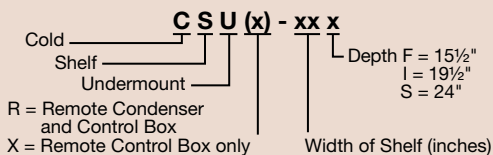



R-290 Drop-In Frost Top Ordering Instructions

Cutaway of **FTBP-2**
with accessory sheet pans

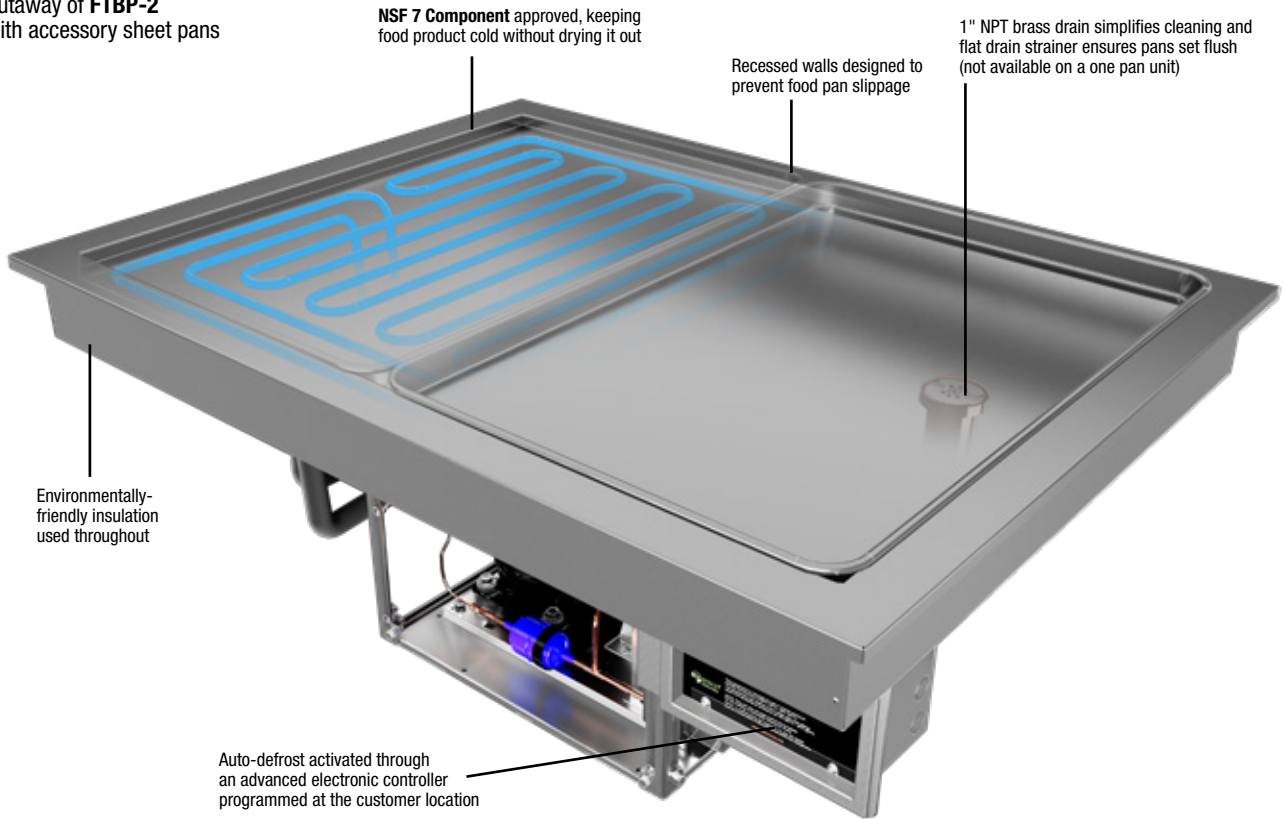

Please specify the following with each order:

1. Number of Full-Size Sheet Pans Accommodated:

1-, 2- or 3-pan as rectangular sheet pans with a Slim or Standard configuration

2. Depth of Model: Standard configuration (28¹⁵/₁₆"D) or Slim configuration (21¹/₁₆"D)

3. Drain – 1" NPT Drain for FTBP-2, FTBP-3, FTBP-S2, FTBP-S3 only (drain plumbing to be installed per local codes)

4. Agency – UL, C-UL, NSF 7 Component

5. Electronic Control Assembly can be mounted on either side of the Condensing Unit or remotely mounted up to 4' from the unit (cannot be mounted over the Condensing Unit)

Option

1. Additional four year parts only warranty on the Compressor available at the time of unit purchase

Accessories

1. Pans –

- A. Half-size sheet pan
18"W x 13"D
- B. Full-size sheet pan
18"W x 26"D

DROP-IN FROST TOP COUNTERTOP CUT-OUTS

Model	Minimum Width	Maximum Width	Minimum Depth	Maximum Depth
FTBP-1	19 ⁷ / ₁₆ "	20 ⁷ / ₈ "	27 ⁷ / ₁₆ "	28 ⁷ / ₈ "
FTBP-2	37 ⁷ / ₈ "	38"	27 ⁷ / ₁₆ "	28"
FTBP-3	55 ³ / ₈ "	56"	27 ⁷ / ₁₆ "	28"
FTBP-S2	53 ³ / ₁₆ "	54"	19 ⁷ / ₁₆ "	20 ⁷ / ₈ "
FTBP-S3	79 ³ / ₁₆ "	79 ⁷ / ₈ "	19 ⁷ / ₁₆ "	20 ⁷ / ₈ "



R-290 Drop-In Frost Tops

Keep your self-serve products - beverages, snacks, hors d'oeuvres, side dishes, desserts and other quick turnaround items - in the perfect chill zone with Hatco R-290 Drop-In Frost Tops.

- Accommodates full-size sheet pans
- Units include a 1" brass drain (excluding one-pan units)
- Optimal insulation on sides and bottom to ensure better cold retention, and built with one of the most efficient condensing units on the market
- Auto-defrost is activated through an advanced electronic controller programmed at the customer location
- Available in a slim, lengthwise configuration to allow for easy, reachable access to products
- Condenser utilizes an environmentally friendly R-290 refrigerant, which has a 90% higher heat absorption capacity than other refrigerants, resulting in quicker temperature recovery and lower energy consumption



FTBP-2 with accessory sheet pans



FTBP-S2

R-290 DROP-IN FROST TOPS

Model	Dimensions W x D x H	Drain (1" Brass Drain)	HP	Hz	Watts	Plug	Approx. Ship Weight	List Price
FTBP-1	21 ¹ / ₁₆ " x 28 ¹ / ₁₆ " x 23 ¹ / ₁₆ "	None	1/5	60	345	NEMA 5-15P	132 lbs.	\$10428
FTBP-2	39" x 28 ¹ / ₁₆ " x 17 ¹ / ₈ "	Yes	1/5	60	345	NEMA 5-15P	170 lbs.	11603
FTBP-3	57" x 28 ¹ / ₁₆ " x 17 ¹ / ₈ "	Yes	1/5	60	345	NEMA 5-15P	213 lbs.	12942
Slim								
FTBP-S2	54 ¹ / ₁₆ " x 21 ¹ / ₁₆ " x 17 ¹ / ₈ "	Yes	1/5	60	345	NEMA 5-15P	182 lbs.	\$11603
FTBP-S3	80 ¹ / ₁₆ " x 21 ¹ / ₁₆ " x 17 ¹ / ₈ "	Yes	1/5	60	345	NEMA 5-15P	239 lbs.	12942

All R-290 Drop-In Frost Top Models Feature:

Voltage: 120V, single phase.

Models Shipped with: Electronic temperature control, condensing unit and compressor.
Consult factory for refrigerant specifications.

NOTE: The installation kit, including the intake bracket, duct clamp, flexible duct, and duct collar, will be shipped separately.

OPTIONS (available at time of purchase only)

EWC	Additional Four Year Parts Only Warranty on the Compressor Available at the Time of Unit Purchase	\$275
------------	---	--------------

ACCESSORIES (available for purchase at any time)

ALUM PAN	Half-Size Sheet Pan – 18"W x 13"D	\$55
18" SHEET PAN	Full-Size Sheet Pan – 18"W x 26"D	77

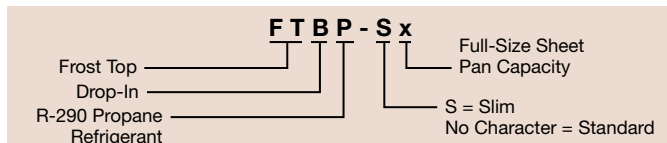



Remote Drop-In Frost Top Ordering Instructions

Cutaway of **FTBR-3**
with accessory sheet pans

Frost Top with:
Temperature Probe

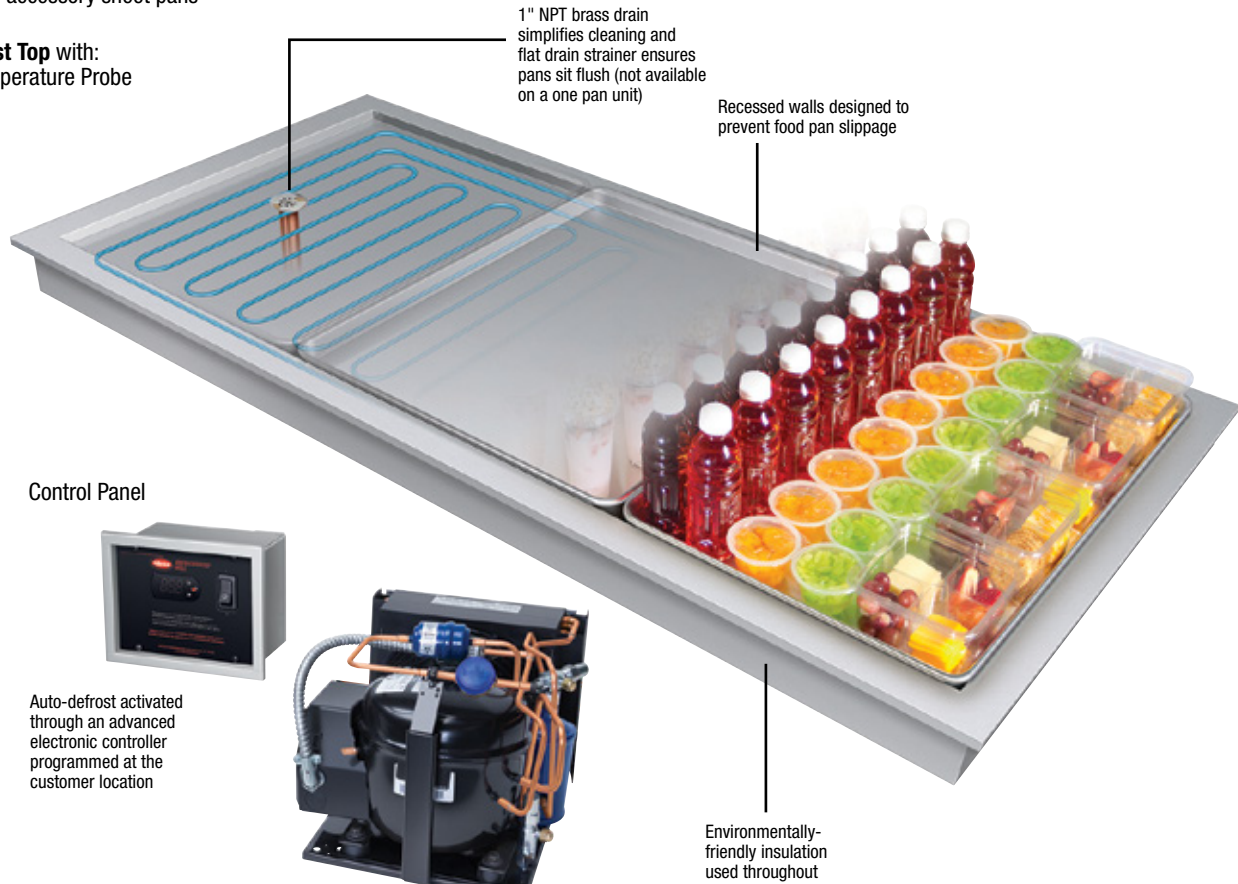

Control Panel

Auto-defrost activated
through an advanced
electronic controller
programmed at the
customer location

FTBR: Condensing Unit
FTBX: No Condensing Unit

NSF 7 Component approved cold
wall construction keeps food product
cold without drying it out

Please specify the following with each order:

- 1. **Number of Full-Size Sheet Pans Accommodated:**
1-, 2- or 3-pan as rectangular sheet pans
- 2. **Depth of Model:** Standard configuration (28¹⁵/₁₆"D)
or Slim configuration (21¹/₁₆"D)
- 3. **Remote Refrigeration**
Note: Shipped loose: Frost Top, Control Panel
(Probe Wires are 9') and a TXV Valve
A. FTBX without a Condensing Unit
(Solenoid Valve attached to Frost Top)
- 4. **Agency** – C-UL, NSF 7 Component

Accessories

- 1. **Pans** –
 - A. Half-size sheet pan
18"W x 13"D
 - B. Full-size sheet pan
18"W x 26"D

REMOTE DROP-IN FROST TOP COUNTERTOP CUT-OUTS

Model	Minimum Width	Maximum Width	Minimum Depth	Maximum Depth
FTBR-1, FTBX-1	27 ⁷ / ₁₆ "	28"	19 ⁷ / ₁₆ "	20 ¹ / ₈ "
FTBR-2, FTBX-2	37 ³ / ₈ "	38"	27 ⁷ / ₁₆ "	28"
FTBR-3, FTBX-3	55 ³ / ₈ "	56"	27 ⁷ / ₁₆ "	28"
FTBR-S2, FTBX-S2	53 ⁵ / ₁₆ "	54"	19 ⁷ / ₁₆ "	20 ¹ / ₈ "
FTBR-S3, FTBX-S3	79 ¹ / ₁₆ "	79 ¹ / ₁₆ "	19 ⁷ / ₁₆ "	20 ¹ / ₈ "





Remote Drop-In Frost Tops

Keeping pre-chilled beverages, snacks, hors d'oeuvres and side dishes cool and ready-to-serve, the Hatco Remote Drop-In Frost Tops offer additional flexibility with remote configurations. Also available in a Slim configuration, providing wider access to your customer.

- Accommodates full-size sheet pans
- Units include a 1" NPT (National Pipe Thread) brass drain (excluding one pan units)
- FTBR models include a condensing unit (shipped loose, can be field mounted up to 50 feet of tubing from unit) and a control panel (shipped loose - probe wires are 9 feet) for installing in more convenient or desirable locations
- FTBX models include a control panel (shipped loose - probe wires are 9 feet) but shipped without a condensing unit for the increased flexibility of multiple Frost Top configurations
- Easy serviceability with a sight glass, service valves, dryer and a receiver (FTBR models only)
- Auto-defrost is activated through an advanced electronic controller programmed at the customer location (FTBR models only)
- Optimal insulation on sides and bottom to ensure better cold retention, and built with one of the most efficient condensing units on the market

FTBR-S2
with accessory
sheet pans



Frost Top with a
temperature
probe, control
panel and
a condensing
unit (both
shipped loose)

FTBX-1 (shipped
without condensing unit)

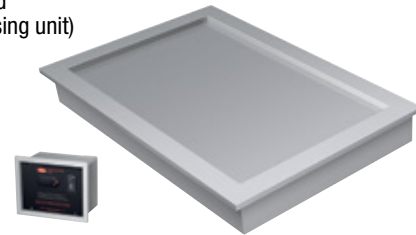

Control panel
(shipped loose)

REMOTE DROP-IN FROST TOPS – WITH CONDENSING UNIT AND CONTROL PANEL

Model	Dimensions W x D x H	HP	Approx. Ship Weight	List Price
FTBR-1 ^o	28 ¹⁵ / ₁₆ " x 21 ¹ / ₁₆ " x 8 ⁵ / ₈ "	1/5	125 lbs.	\$10395
FTBR-2	39" x 28 ¹⁵ / ₁₆ " x 8 ⁵ / ₈ "	1/5	151 lbs.	11709
FTBR-3	57" x 28 ¹⁵ / ₁₆ " x 8 ⁵ / ₈ "	1/5	213 lbs.	13183
Slim				
FTBR-S2	54 ¹⁵ / ₁₆ " x 21 ¹ / ₁₆ " x 8 ⁵ / ₈ "	1/5	179 lbs.	\$11842
FTBR-S3	80 ¹³ / ₁₆ " x 21 ¹ / ₁₆ " x 8 ⁵ / ₈ "	1/5	230 lbs.	13413

^o No drain

All Remote Drop-In Frost Top Models Feature:

Voltage – FTBR-1, -2, -3, -S2, -S3: 120V, 300 watts, 60 Hz, single phase.

Models Shipped with: Electronic temperature control, condensing unit and TXV valve (all shipped loose). Consult factory for refrigerant specifications.

REMOTE DROP-IN FROST TOPS – WITH CONTROL PANEL

Model	Dimensions W x D x H	BTU/ Hour	Approx. Ship Weight	List Price
FTBX-1 ^o	28 ¹⁵ / ₁₆ " x 21 ¹ / ₁₆ " x 8 ⁵ / ₈ "	330	85 lbs.	\$ 8472
FTBX-2	39" x 28 ¹⁵ / ₁₆ " x 8 ⁵ / ₈ "	630	138 lbs.	9785
FTBX-3	57" x 28 ¹⁵ / ₁₆ " x 8 ⁵ / ₈ "	930	220 lbs.	11260
Slim				
FTBX-S2	54 ¹⁵ / ₁₆ " x 21 ¹ / ₁₆ " x 8 ⁵ / ₈ "	630	130 lbs.	\$ 9917
FTBX-S3	80 ¹³ / ₁₆ " x 21 ¹ / ₁₆ " x 8 ⁵ / ₈ "	930	182 lbs.	11490

All Remote Drop-In Frost Top Models Feature:

Voltage: 120, single phase.

Models Shipped with: Electronic temperature control, TXV valve (shipped loose) and a solenoid valve attached to well.

OPTIONS (available at time of purchase only)

EWC	Additional Four Year Extended Parts Only Warranty on the Compressor (FTBR only)	\$275
------------	--	--------------

ACCESSORIES (available for purchase at any time)

ALUM PAN	Half-Size Sheet Pan – 18"W x 13"D	\$55
18" SHEET PAN	Full-Size Sheet Pan – 18"W x 26"D	77

COUNTERTOP CUT-OUT DIMENSIONS – PAGE 39

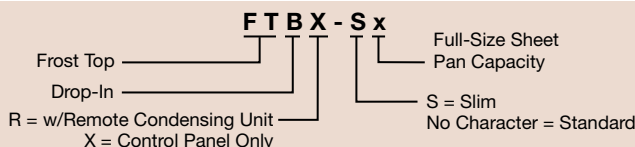

Sneeze Guards





Integrated Flav-R-Shield® Sneeze Guards

Enhance the functionality of your Hatco Flav-R-Shield® Sneeze Guards with the seamless integration of a Hatco GR5AHL Glo-Ray® Curved Strip Heater or HL5 Glo-Rite® Curved Display Light. This provides energy-efficient heat to keep food items at the ideal temperature while safeguarding against airborne contaminants. You can easily customize and quote

your perfect Flav-R-Shield Sneeze Guard with an integrated GR5AHL through our user-friendly configurator on www.hatcosneezeguards.com. Simply visit our site, select your preferred model, and configure the perfect solution for your needs. Keep your foodservice operations safe, warm, and efficient! Visit Hatco's Sneeze Guard configurator to learn more.



ES90



ORBIT900



EP12

For custom Sneeze Guard bundles, contact us at sneezeguards@hatcocorp.com.



Double-Sided Self-Service Sneeze Guard Model **ES92** with **GR5AHL** Strip Heaters

Sneeze Guards

Configure it!

Hatco has made it a snap to create a customized Sneeze Guard to your exact specifications, with one of the most powerful online configurators to date. Once you arrive at the Hatco Sneeze Guard website (scan QR code to the right or use this URL: www.hatcosneezeguards.com), please click on your choice:

- Full-Service
- Barrier
- Convertible
- Self-Serve
- Portable
- ORBIT

...and click on Quotation. You'll be directed to the configurator for that product.

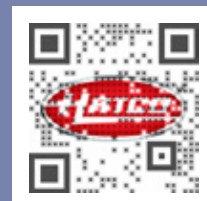

Configure your Hatco Flav-R-Shield® Sneeze Guard today!



Full-Service Sneeze Guards

Crafted from high-quality, durable materials, Hatco's Flav-R-Shield® Full-Service Sneeze Guards are designed to provide clear, unobstructed views while creating a safe barrier. Whether you need a quick and standard size, or custom options, our full-service sneeze guards have the coverage. Easy to install and maintain, our sneeze guards offer multiple styles of mounting, custom sizing and measurements, along with secure end panels for maximum coverage. With a variety of sizes and styles, we ensure your space is protected without compromising on functionality. Stay safe, stay secure, and let us help you create a healthier environment.

- Full-service models: ED20, EP5, EP5-RING, EP7, EP11, EP12, EP15, EP21, EP22, EP36, ORBIT100, ORBIT900
- Available with four mounting styles
- Most models available with one to four bays. Bay widths are up to 66" (model dependent)
- Constructed of durable thick tempered glass
- Mount to stainless steel, natural and engineered solid stone surfaces, and laminate countertops
- Posts available in Matte Black or Brushed Stainless finishes
- Optional LED lights available



EP5



ORBIT100



EP11



EP12



ED20



ORBIT900

Full-Service Sneeze Guard Model **ED20**



Sneeze Guards

Configure it!

Hatco has made it a snap to create a customized Sneeze Guard to your exact specifications, with one of the most powerful online configurators to date. Once you arrive at the Hatco Sneeze Guard website (scan QR code to the right or use this URL: www.hatcosneezeguards.com), please click on your choice:

- Full-Service
- Barrier
- Convertible
- Self-Serve
- Portable
- ORBIT

...and click on Quotation. You'll be directed to the configurator for that product.

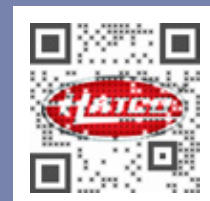

Configure your Hatco Flav-R-Shield® Sneeze Guard today!



Self-Service Sneeze Guards

The Hatco Flav-R-Shield® Self-Service Sneeze Guards are designed to provide top-tier protection while maintaining an accessible and efficient self-service experience. Available in a stylish Matte Black or classic Brushed Stainless, these sneeze guards offer style with optimal safety, ensuring customers, staff, and product are protected. Key features include custom sizing, mounting styles, and lighting to suit any need. The Hatco Self-Service Sneeze Guard combines functionality and style to elevate your foodservice operations while keeping everyone protected.

- Self-service models: B950, B950SWIVEL, ES29, ES31, ES40, ES53, ES67, ES73, ES82, ES90, ES92, ORBIT360
- Available with four mounting styles
- Most models available with one to four bays. Bay widths are up to 75" (model dependent)
- Constructed of durable thick tempered glass
- Mount to stainless steel, natural and engineered solid stone surfaces, and laminate countertops
- Posts available in Matte Black or Brushed Stainless finishes
- Optional LED lights available



ES29



ES82



ES67



ES90



ES92



B950



Self-Service Sneeze Guard Model ES82

Sneeze Guards

Configure it!

Hatco has made it a snap to create a customized Sneeze Guard to your exact specifications, with one of the most powerful online configurators to date. Once you arrive at the Hatco Sneeze Guard website (scan QR code to the right or use this URL: www.hatcosneezeguards.com), please click on your choice:

- Full-Service
- Barrier
- Convertible
- Self-Serve
- Portable
- ORBIT

...and click on Quotation. You'll be directed to the configurator for that product.

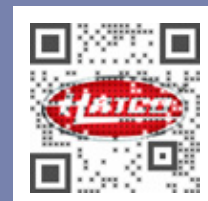

Configure your Hatco Flav-R-Shield® Sneeze Guard today!



Portable Sneeze Guards

The Hatco Flav-R-Shield® Portable Sneeze Guard is the ultimate solution for flexible, on-the-go protection for foodservice operations. Engineered for versatility, it offers a portable, high-quality barrier that ensures safety and cleanliness without sacrificing convenience. When not in use, it can be stored easily without taking up excess space, making it ideal for limited storage situations. The portable sneeze guards are equipped with a sturdy base to prevent tipping or instability, even in high-traffic environments. They are simple to assemble and disassemble, making them perfect for events, catering, or quickly transforming any space into a safe serving area.

- Portable models: ALLIN1, B950P, EP6, EP950, ORBIT720
- Constructed of durable thick tempered glass (B950P, EP6, ORBIT720) or thick acrylic (ALLIN1, EP950)
- Mounting feet allow for easy portability
- ALLIN1 models are collapsible and stack flat for easy storage
- Custom front glass angles (excludes EP6)
- Posts available in Matte Black or Brushed Stainless finishes
- Optional LED lights with battery pack available



ALLIN1



B950-P



EP6



EP950



Portable Sneeze Guard Model **EP950**

Sneeze Guards

Configure it!

Hatco has made it a snap to create a customized Sneeze Guard to your exact specifications, with one of the most powerful online configurators to date. Once you arrive at the Hatco Sneeze Guard website (scan QR code to the right or use this URL: www.hatcosneezeguards.com), please click on your choice:

- Full-Service
- Barrier
- Convertible
- Self-Serve
- Portable
- ORBIT

...and click on Quotation. You'll be directed to the configurator for that product.

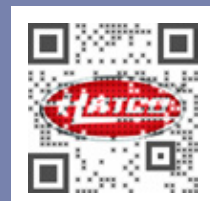

Configure your Hatco Flav-R-Shield® Sneeze Guard today!

Strip Heaters



Ordering Instructions – Watch How To Order A Hatco Strip Heater on Hatco's website under Resources, Video Library

QUICK GUIDE – SOLUTIONS FOR ANY CLEARANCE – Detailed mounting and spacing requirements found on page 123

NARROW CLEARANCE

Infra-Black®

- Provides a very even and thermostatically controlled heat source
- For applications where the distance from the heat source to the target is narrow

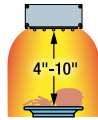

STANDARD CLEARANCE

Infrared Metal Sheathed Element:

- Pre-focused heat pattern directs infrared heat to the holding area
- Uniform heat distribution
- Energy efficient
- A wide variety of sizes and features available
- Our most popular solution

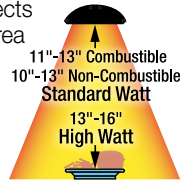

HIGH CLEARANCE

Ultra-Glo® Durable Ceramic Element

- Stronger, more intense heat source
- For applications where there is a greater distance between the heat source and target surface
- Ideal for French fry station applications

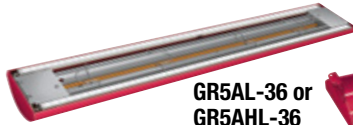
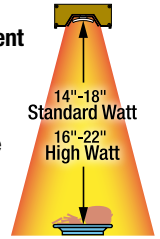

GR5AL-36 or GR5AHL-36



GR5A-36 or GR5AH-36

Glo-Ray® Curved Infrared Strip Heaters: (pages 96-98)

1. Choose a length
2. Standard or high watt
3. Lights or no lights
4. Voltage: 120, 208, 240
5. Choose control option for GR5A and GR5AH ** (GR5AL, GR5AHL have Remote Control Enclosure included)



GRA-72, GRAH-72 or GRAM-72



GRA-72D, GRAH-72D or GRAM-72D



GRAL-72, GRAHL-72 or GRAML-72



GRAL-72D, GRAHL-72D or GRAML-72D

Glo-Ray® Infrared Metal-Sheathed Strip Heaters: (pages 99-114)

1. Choose a length
2. Single or dual warmer
3. Standard, high or max watt
4. Lights or no lights
5. Voltage: 120, 208, 240 without lights or 120, 240, 120/208, 120/240 for units with lights
6. Choose control option, remote installation recommended (required on some models)**

GR-36 or GRH-36

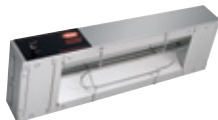

Glo-Ray® Infrared Stainless Steel Strip Heaters: (pages 100-101)

1. Choose a length
2. Standard or high watt
3. Voltage: 120, 208 or 240
4. Choose control option, remote installation is recommended**



GR2A-36 or GR2AH-36



GR2A-36D or GR2AH-36D



GR2AL-36 or GR2AHL-36



GR2AL-36D or GR2AHL-36D

Glo-Ray® Designer Infrared Strip Heaters: (pages 105-109)

1. Choose a length
2. Single or dual warmer
3. Standard or high watt
4. Lights or no lights
5. Voltage: 120, 208, 240 without lights or 120/208, 120/240 for units with lights
6. Choose control option, remote installation only**
7. Choose inset panel and corner cap color
8. Select Non-adjustable Stand Length or optional Overhead Mount (shown)

**Multiple Strip Heaters may be connected to one RMB2 if the combined Amp draw of the warmers are less than the rating for the RMB2.



GRN-24,
GRNH-24 or
GRNM-24



Glo-Ray® Narrow Infrared Strip Heaters: (page 115-116)

1. Choose a length
2. Standard, high or max watt
3. Voltage: 120, 208, 240
4. Choose control option, remote installation is recommended**

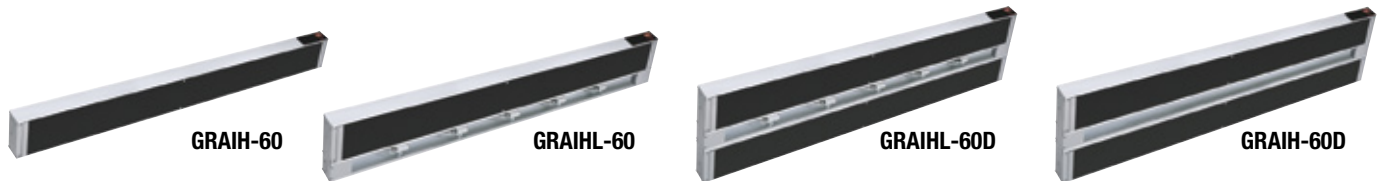

Glo-Ray® Infra-Black® Strip Heaters: (pages 117-119)

1. Choose a length
2. Single or dual warmer
3. Lights or no lights
4. Voltage: 120, 208, 240 without lights or 120/208, 120/240 for units with lights
5. Choose control option, remote installation is recommended**



Ultra-Glo® Ceramic Strip Heaters: (pages 120-122)

1. Choose a length
2. Single or dual warmer
3. Standard or high watt
4. Lights or no lights
5. Voltage: 120, 208, 240 without lights or 120/208, 120/240 for units with lights
6. Choose control option, remote installation is recommended**

**Multiple Strip Heaters may be connected to one RMB2 if the combined Amp draw of the warmers are less than the rating for the RMB2.

Strip Heaters

Power and Switch Location

Each Strip Heater has specific Power and Switch locations (sample below). For information on other models, visit the *Document Library* under *Resources* on hatcocorp.com, and search *Power Locations*.

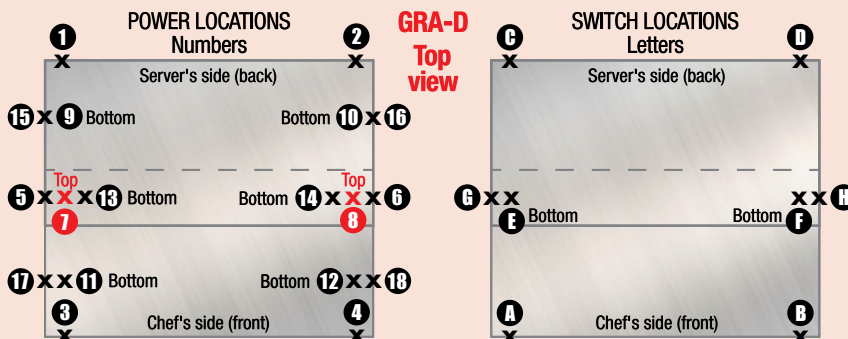

POWER: Numbers indicate potential power locations. Locations 9, 10, 11 and 12 are on the bottom of the warmer and are intended to be used in conjunction with the optional legs supplied by Hatco. Note: Maximum of 3 circuits down the leg. **SWITCH:** Letters indicate the potential control locations.

NOTE: Remote controls are available and recommended.

Typical Conduit Connection

Glo-Ray® Strip Heaters come standard with right angle attached 3' conduit and 42" leads on back of unit.

Narrow Strip Heaters have standard 6" leads, no conduit.

GR2A models - conduit exits non-adjustable stand or overhead mount only. **GR5AL** models have a 5' leadwire, which is 2' past the 3' conduit.

Ultra Glo® models - conduit exits through attached control box; if no control box, conduit exits side of unit.

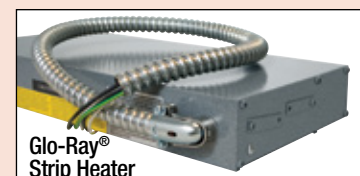



Glo-Ray® Curved Infrared Strip Heaters

This stylish, patented design, based on our signature Glo-Ray Strip Heaters, is the perfect solution for your front-of-the-house applications. Superb for buffet and serving lines, the sleek curved design minimizes its size while accenting and warming the products below.

The entire holding surface is heated evenly with no "cold" spots thanks to Hatco's dependable infrared element technology.

- Narrow, curved design: 2"H x 6"D uses a very small footprint
- Lengths available from 18"-72" in 6" increments
- Patented housing design
- Angle brackets (mounting) are standard

- Pre-focused heat maintains safe serving temperatures longer without continuing to cook the food
- Available in standard or high watt
- End panels and mounting brackets match unit color
- Hatco's wide array of colors help provide the right look for your venue



GR5A-36/GR5AH-36 with new accessory Sneeze Guard (with Clear Anodized hardware), in optional Glossy Gray Gloss Finish with optional 16" non-adjustable tubular stands (legs) in optional Glossy Gray Finish

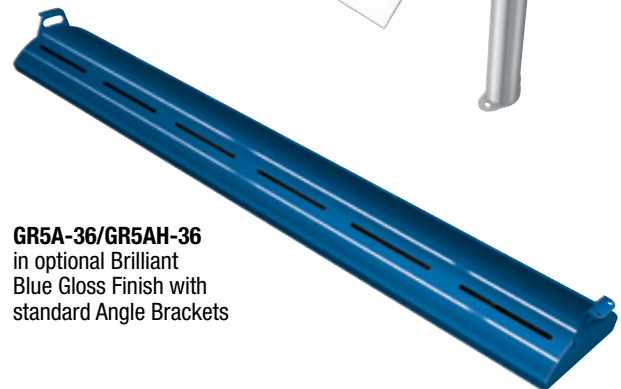

GR5A-36/GR5AH-36 in optional Brilliant Blue Gloss Finish with standard Angle Brackets

GLO-RAY CURVED INFRARED STRIP HEATERS

Model	Width	Voltage Single Phase	Approx. Watts	Approx. Ship Weight	List Price ^o
Standard Watt					
GR5A-18	18"	120, 208 or 240	250	10 lbs.	\$1146
GR5A-24	24"	120, 208 or 240	350	11 lbs.	1226
GR5A-30	30"	120, 208 or 240	450	12 lbs.	1307
GR5A-36	36"	120, 208 or 240	575	12 lbs.	1387
GR5A-42	42"	120, 208 or 240	675	13 lbs.	1468
GR5A-48	48"	120, 208 or 240	800	15 lbs.	1550
GR5A-54	54"	120, 208 or 240	925	17 lbs.	1629
GR5A-60	60"	120, 208 or 240	1050	20 lbs.	1711
GR5A-66	66"	120, 208 or 240	1160	25 lbs.	1791
GR5A-72	72"	120, 208 or 240	1275	25 lbs.	1872
High Watt					
GR5AH-18	18"	120, 208 or 240	350	10 lbs.	\$1157
GR5AH-24	24"	120, 208 or 240	500	11 lbs.	1237
GR5AH-30	30"	120, 208 or 240	660	12 lbs.	1318
GR5AH-36	36"	120, 208 or 240	800	12 lbs.	1398
GR5AH-42	42"	120, 208 or 240	950	13 lbs.	1479
GR5AH-48	48"	120, 208 or 240	1100	15 lbs.	1561
GR5AH-54	54"	120, 208 or 240	1250	17 lbs.	1640
GR5AH-60	60"	120, 208 or 240	1400	20 lbs.	1722
GR5AH-66	66"	120, 208 or 240	1560	25 lbs.	1802
GR5AH-72	72"	120, 208 or 240	1725	25 lbs.	1883

^o Does not include Remote Control Enclosure (RMB), see pages 98, 125 and 126.
! Infinite switch not available on 120V.

All Glo-Ray Curved Infrared Models Feature:

Leads: 3' conduit, 5' Power Leads.

Angle Brackets: Provides 1" clearance between Strip Heater and overshef.

Dimensions: 18"-72"W x 6"D x 2"H.

OPTIONS AND ACCESSORIES – PAGE 98

RECOMMENDED MOUNTING HEIGHTS – PAGE 123

COLORS AND FINISHES – PAGE 241

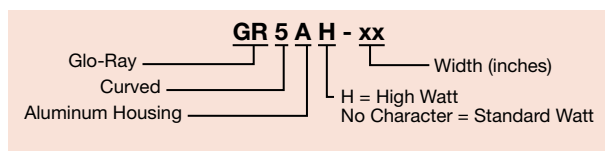



Glo-Ray® Curved Infrared Strip Heaters with LED Lights

Hatco's Glo-Ray Curved Infrared Strip Heaters with LED Lights feature a patented housing design that is low-profile, elliptical-shaped and stylish, the ideal solution for front-of-the-house applications where heat and/or lights are needed.

It can operate with just the dual LED lights; or the dual LED lights can be used simultaneously with the infrared emitter to provide the perfect balance of light and heat.

- Narrow, curved design: 2"H x 6"D uses a very small footprint with lengths available from 18"-72" in 6" increments
- Patented housing design has energy efficient dual LED lights across the entire strip heater, which provide longer performance and energy savings (compared to standard incandescent bulbs - 3.5 to 15.2 watts based on length)
- Angle brackets (mounting) are standard
- Pre-focused heat maintains safe serving temperatures longer without continuing to cook the food
- Can be used with lights only or heat only
- 100% linear infinite controls with adjustability from 0-100%, allow for precise settings
- Field replaceable LED available as:
 - Warm White* (standard)
 - Neutral (Cool) White*
 - Dual Color: Warm White/Neutral (Cool) White* (toggle between color temperatures to enhance foods displayed)
- Electronic Infinite Control Remote Box and power On/Off switch (controls lights, heat) included
- Available as lights only (see HL5 series in Decorative Lamps & Display Lights section)



GR5AL-36/GR5AHL-36
Top and bottom view. Shown in optional Radiant Red Gloss Finish and standard Angle Brackets

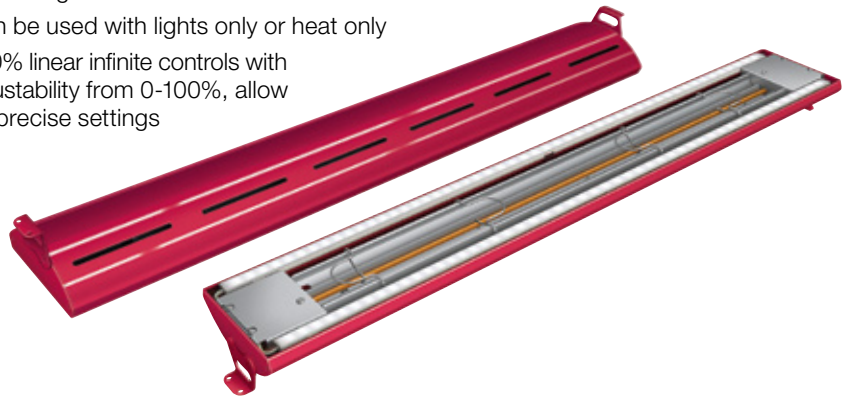

GLO-RAY CURVED INFRARED STRIP HEATERS with LED LIGHTS

Model	Width	Voltage Single Phase	Watts	Approx. Ship Weight	List Price
Standard Watt					
GR5AL-18	18"	120, 208 or 240	254	16 lbs.	\$3802
GR5AL-24	24"	120, 208 or 240	356	18 lbs.	4019
GR5AL-30	30"	120, 208 or 240	458	21 lbs.	4237
GR5AL-36	36"	120, 208 or 240	584	21 lbs.	4453
GR5AL-42	42"	120, 208 or 240	686	24 lbs.	4671
GR5AL-48	48"	120, 208 or 240	812	24 lbs.	4888
GR5AL-54	54"	120, 208 or 240	939	27 lbs.	5105
GR5AL-60	60"	120, 208 or 240	1066	28 lbs.	5322
GR5AL-66	66"	120, 208 or 240	1177	29 lbs.	5539
GR5AL-72	72"	120, 208 or 240	1294	30 lbs.	5756
High Watt					
GR5AHL-18	18"	120, 208 or 240	354	16 lbs.	\$3813
GR5AHL-24	24"	120, 208 or 240	506	17 lbs.	4030
GR5AHL-30	30"	120, 208 or 240	668	21 lbs.	4248
GR5AHL-36	36"	120, 208 or 240	809	21 lbs.	4464
GR5AHL-42	42"	120, 208 or 240	961	22 lbs.	4682
GR5AHL-48	48"	120, 208 or 240	1112	25 lbs.	4899
GR5AHL-54	54"	120, 208 or 240	1264	25 lbs.	5116
GR5AHL-60	60"	120, 208 or 240	1416	29 lbs.	5333
GR5AHL-66	66"	120, 208 or 240	1577	29 lbs.	5550
GR5AHL-72	72"	120, 208 or 240	1744	30 lbs.	5767



Optional Sneeze Guard with black Anodized hardware

Strip Heaters

All Glo-Ray Curved Infrared Models with Lights Feature:

Switch Location: Remote box with electronic infinite control and power On/Off switch (controls lights and heat) included.
Leads: 3' conduit, 5' Power Leads, 6½' (78") LED Leads. Standard LED lead length is 1½' (18") longer than Power Lead length.
Angle Brackets: Provides 1" clearance between strip heater and overshef.
Dimensions: 18"-72"W x 6"D x 2"H. **Control Box Dimensions:** 11"W x 5½"H.
Cut Out Dim.: 10⅞"W x 6¼"D x 4¾"H.

OPTIONS AND ACCESSORIES – PAGE 98
RECOMMENDED MOUNTING HEIGHTS – PAGE 123
COLORS AND FINISHES – PAGE 241

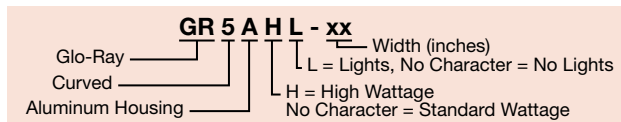

RECOMMENDED LIGHT USAGE

GR5A(H)L above...	Warm White*	Cool White*	Warm/Neutral (Cool) White*
Heated Well(s)	X		
Refrigerated Well(s)		X	
Heated Shelf (Shelves)	X		
Refrigerated Shelf (Shelves)		X	
Hot/Cold Well(s)			X
Hot/ Cold Shelf (Shelves)			X

* Warm White can range from 2700-3200K, Neutral (Cool) White from 4000-4300K



OPTIONS (available at time of purchase only)

Designer Colors – End panels and Angle Brackets match unit color – Non-standard colors are non-returnable –				per foot	\$52			
RED	Warm Red	BLACK	Black	GRAY	Gray Granite	COPPER	Antique Copper	
WHITE	White Granite	BLUE	Navy Blue	GREEN	Hunter Green			
Gloss Finishes – End panels and Angle Brackets match unit color – Non-standard colors are non-returnable –				per foot	\$72			
GGOLD	Gleaming Gold	BBLUE	Brilliant Blue	GGRAY	Glossy Gray			
RRED	Radiant Red	BBLACK	Bold Black					
Non-Adjustable Tubular Stands – Clear Anodized standard –								
Bottom mount leg for bottom mount installation								
	NTL5-10, -12	Specify 10" or 12" clearance				1 pair	\$264	
	NTL5-14, -16	Specify 14" or 16" clearance				1 pair	332	
Side mount leg for bottom mount installation								
	SNTL5-10B, -12B	Specify 10" or 12" clearance				1 pair	\$357	
	SNTL5-14B, -16B	Specify 14" or 16" clearance				1 pair	405	
Side mount leg for top mount installation								
	SNTL5-10T, -12T	Specify 10" or 12" clearance				1 pair	\$357	
	SNTL5-14T, -16T	Specify 14" or 16" clearance				1 pair	405	
NTL5-PAINT	<i>Designer Color or Gloss Finish for Non-Adjustable Tubular Stands – Non-standard colors are non-returnable –</i>						1 pair	74
	RED	Warm Red	GRAY	Gray Granite	NAVY	Navy Blue	COPPER	Antique Copper
	BLACK	Black	WHITE	White Granite	GREEN	Hunter Green		
	RRED	Radiant Red	GGRAY	Glossy Gray	BBLACK	Bold Black		
	GGOLD	Gleaming Gold	BBLUE	Brilliant Blue				
GR5AL-NW	Neutral (Cool) White LED – Neutral (Cool) White can range from 4000-4300K						No Charge	
GR5AL-WW/NW	Dual Warm/Neutral (Cool) White LED – Warm White can range from 2700-3200K, Neutral (Cool) White from 4000-4300K						\$545	
GR5AL-OPP	Power and LED wiring exit opposite ends of unit (Same end is the standard offering) – Must specify Power Lead length and LED Lead length required –						No Charge	
Power Wire Leads – GR5A(H) models – 5' Power Lead length standard –								
	GR5A-LEADS10	6'-10' total Power Lead length					\$43	
	GR5A-LEADS15	11'-15' total Power Lead length					85	
Power Wire Leads – GR5A(H)L models – 5' Power Lead length standard –								
	GR5AL-LEADS10	6'-10' total power Lead length					\$43	
	GR5AL-LEADS15	11'-15' total power Lead length					85	
LED Leads – 6½' (78") LED Lead length Standard – Standard LED lead length is 1½' (18") longer than Power Lead length								
	LED-LEADS10	11½' (138") total LED Lead length					\$ 66	
	LED-LEADS15	16½' (198") total LED Lead length					132	
	LED-LEADS20	21½' (258") total LED Lead length					198	
NO CONTROL	GR5A(H) models only – No control included, requires selection of RMB2-xx control – page 125						No Charge	
REM INF	GR5A(H) models only – Remote Infinite Switches in lieu of Toggle (max. 12.2 Amps) –						\$ 76	
REM TOG	GR5A(H) models only – Remote Toggle Switches (max. 15 Amps) –						No Charge	
RMB	GR5A(H) models only – Remote Box – Available in <i>Designer Colors</i> or <i>Gloss Finishes</i> – see page 126							
	Non-standard colors are non-returnable – Clear Anodized standard –							
RMB5-2R	Remote Box for GR5A(H)L models – Allows for up to two 72" wide units to be connected to a single control box at same set points – 14"W x 5 ¹⁵ / ₁₆ "D x 5½"H (Cut out dimensions: 13 ¹ / ₈ "W x 4 ³ / ₄ "H)						\$1855	

ACCESSORIES (available for purchase at any time)

Curved tempered glass Sneeze Guard with penciled, polished edges for GR5A(H), GR5A(H)L models only – 24" D x 4 1/8" H

With Black Anodized hardware			With Clear Anodized hardware		
SG5-18-BA	Sneeze Guard fits GR5A(H)(L)-18 models	\$ 846	SG5-18-CA	Sneeze Guard fits GR5A(H)(L)-18 models	\$ 846
SG5-24-BA	Sneeze Guard fits GR5A(H)(L)-24 models	862	SG5-24-CA	Sneeze Guard fits GR5A(H)(L)-24 models	862
SG5-30-BA	Sneeze Guard fits GR5A(H)(L)-30 models	887	SG5-30-CA	Sneeze Guard fits GR5A(H)(L)-30 models	887
SG5-36-BA	Sneeze Guard fits GR5A(H)(L)-36 models	920	SG5-36-CA	Sneeze Guard fits GR5A(H)(L)-36 models	920
SG5-42-BA	Sneeze Guard fits GR5A(H)(L)-42 models	1018	SG5-42-CA	Sneeze Guard fits GR5A(H)(L)-42 models	1018
SG5-48-BA	Sneeze Guard fits GR5A(H)(L)-48 models	1058	SG5-48-CA	Sneeze Guard fits GR5A(H)(L)-48 models	1058
SG5-54-BA	Sneeze Guard fits GR5A(H)(L)-54 models	1083	SG5-54-CA	Sneeze Guard fits GR5A(H)(L)-54 models	1083
SG5-60-BA	Sneeze Guard fits GR5A(H)(L)-60 models	1156	SG5-60-CA	Sneeze Guard fits GR5A(H)(L)-60 models	1156
SG5-66-BA	Sneeze Guard fits GR5A(H)(L)-66 models	1180	SG5-66-CA	Sneeze Guard fits GR5A(H)(L)-66 models	1180
SG5-72-BA	Sneeze Guard fits GR5A(H)(L)-72 models	1204	SG5-72-CA	Sneeze Guard fits GR5A(H)(L)-72 models	1204



RMB5-2R



SG5-BA (black anodized hardware)

RECOMMENDED MOUNTING HEIGHTS – PAGE 123
COLORS AND FINISHES – PAGE 241



Glo-Ray® Aluminium Infrared Strip Heaters

Safely hold the temperature of your product without drying out or further cooking food with these Strip Heaters. The end result is hot, fresh food that's ready-to-serve. The continuous aluminum housing and heavy-duty mountings ensure the durability and quality of Hatco products. Heavy-duty Stainless Steel housings are available (next page).

- Ensures maximum flavor, safety and holding time
- Even heat distribution – no “cold spots”
- Sturdy extruded aluminum housings that do not sag, from 18" to 144" (12')
- Reflector does not blacken, maintaining a consistent heat pattern
- Heavy-duty insulation minimizes heat loss
- Optional Sneeze Guards (excludes Stainless Steel models)
- Available in Stainless Steel housing 18" to 96"
- Available with lights (shatter resistant incandescent lights or optional halogen lights - excludes Stainless Steel models)

- Pre-focused heat pattern bathes entire holding surface
- Additional reflector styles and lower wattage elements available, consult factory for more information

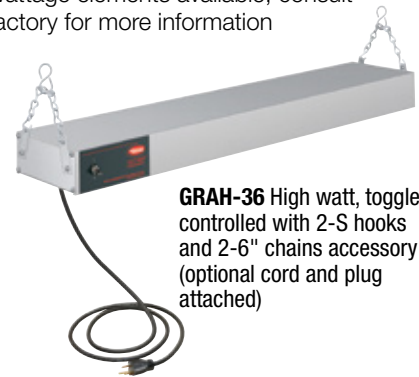

GRAH-36 High watt, toggle controlled with 2-S hooks and 2-6" chains accessory (optional cord and plug attached)

Toggle Switch: Max. 15 Amps
Infinite Switch: Max. 12.2 Amps

Quick-Ship Program Information Inside Back Cover

ALUMINUM STRIP HEATERS with CONDUIT (Standard Watt)

Model	Width	Voltage Single Phase	Watts	Approx. Ship Weight	List Price ^o
Standard Watt					
GRA-18	18"	120, 208 or 240	250	7 lbs.	\$ 515
✓ GRA-24	24"	120, 208 or 240	350	7 lbs.	541
✓ GRA-30	30"	120, 208 or 240	450	8 lbs.	580
✓ GRA-36	36"	120, 208 or 240	575	9 lbs.	616
✓ GRA-42	42"	120, 208 or 240	675	10 lbs.	654
✓ GRA-48	48"	120, 208 or 240	800	11 lbs.	696
✓ GRA-54	54"	120, 208 or 240	925	13 lbs.	740
✓ GRA-60	60"	120, 208 or 240	1050	14 lbs.	789
✓ GRA-66	66"	120, 208 or 240	1160	16 lbs.	868
✓ GRA-72	72"	120, 208 or 240	1275	17 lbs.	981
✓ GRA-84	84"	120, 208 or 240	1500	19 lbs.	1134
✓ GRA-96	96"	120, 208 or 240	1725	21 lbs.	1291
✓ GRA-108	108"	120, 208 or 240	1850	24 lbs.	1628
✓ GRA-120	120"	120, 208 or 240	2100	26 lbs.	1769
✓ GRA-132	132"	120, 208 or 240	2320	30 lbs.	1913
✓ GRA-144	144"	120, 208 or 240	2550	33 lbs.	2054

^o Does not include Remote Control Enclosure (RMB), see pages 125 and 126.
✓ When using an infinite control with 120 volt model, additional switch(es) and tandem (end-to-end) elements are required, cord not available.
✓ 120 volt models require additional switches and tandem (end-to-end) elements.
↔ Models 108" and longer are tandem.

All Glo-Ray Aluminum Infrared Models Feature:

Toggle Switch (max. 15 Amps) Location: Chef's left side (unless otherwise specified).
Leads: 3' conduit with leads – server's right. NEMA 5-15P cord available on 120 volt models 72" or less with C-leg, T-leg stand or chain-hook mount. GRAH-66 and GRAH-72 require NEMA 5-20P cord.
Dimensions: 18"-144"W x 6"D x 2½"H.

OPTIONS AND ACCESSORIES – PAGE 101
RECOMMENDED MOUNTING HEIGHTS – PAGE 123

ALUMINUM STRIP HEATERS with CONDUIT (High Watt)

Model	Width	Voltage Single Phase	Watts	Approx. Ship Weight	List Price ^o
High Watt					
✓ GRAH-18	18"	120, 208 or 240	350	7 lbs.	\$ 526
✓ GRAH-24	24"	120, 208 or 240	500	8 lbs.	552
✓ GRAH-30	30"	120, 208 or 240	660	8 lbs.	591
✓ GRAH-36	36"	120, 208 or 240	800	9 lbs.	627
✓ GRAH-42	42"	120, 208 or 240	950	11 lbs.	665
✓ GRAH-48	48"	120, 208 or 240	1100	11 lbs.	707
✓ GRAH-54	54"	120, 208 or 240	1250	13 lbs.	751
✓ GRAH-60	60"	120, 208 or 240	1400	14 lbs.	800
✓ GRAH-66	66"	120, 208 or 240	1560	16 lbs.	879
✓ GRAH-72	72"	120, 208 or 240	1725	17 lbs.	992
✓ GRAH-84	84"	120, 208 or 240	2050	19 lbs.	1145
✓ GRAH-96	96"	120, 208 or 240	2400	21 lbs.	1302
✓ GRAH-108	108"	120, 208 or 240	2500	23 lbs.	1639
✓ GRAH-120	120"	120, 208 or 240	2800	26 lbs.	1780
✓ GRAH-132	132"	120, 208 or 240	3120	31 lbs.	1924
✓ GRAH-144	144"	120, 208 or 240	3450	48 lbs.	2065

Quick-Ship Program Information Inside Back Cover

ALUMINUM STRIP HEATERS with S HOOKS, CHAINS and CORD and PLUG ATTACHED

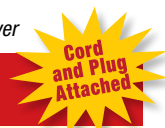

Model	Item No.	Width	Voltage Single Phase	Watts	Approx. Ship Weight	List Price
Standard Watt - Toggle Controlled with S Hooks and Chain, Cord and Plug attached						
✓ GRA-24	GRA24120TCCS	24"	120	350	7 lbs.	\$622
✓ GRA-36	GRA36120TCCS	36"	120	575	9 lbs.	697
✓ GRA-48	GRA48120TCCS	48"	120	800	11 lbs.	777
✓ GRA-60	GRA60120TCCS	60"	120	1050	14 lbs.	870
High Watt - Toggle Controlled with S Hooks and Chain, Cord and Plug attached						
✓ GRAH-18	AH18120TCCS	18"	120	350	6 lbs.	\$607
✓ GRAH-24	AH24120TCCS	24"	120	500	7 lbs.	633
✓ GRAH-30	AH30120TCCS	30"	120	660	8 lbs.	672
✓ GRAH-36	AH36120TCCS	36"	120	800	9 lbs.	708
✓ GRAH-42	AH42120TCCS	42"	120	950	10 lbs.	746
✓ GRAH-48	AH48120TCCS	48"	120	1100	11 lbs.	864
✓ GRAH-60	AH60120TCCS	60"	120	1400	14 lbs.	881
High Watt - Infinite Controlled with S Hooks and Chain, Cord and Plug attached						
✓ GRAH-24	AH24120ICCS	24"	120	500	7 lbs.	\$709
✓ GRAH-36	AH36120ICCS	36"	120	800	9 lbs.	748
✓ GRAH-48	AH48120ICCS	48"	120	1100	11 lbs.	864
✓ GRAH-60	AH60120ICCS	60"	120	1400	14 lbs.	957

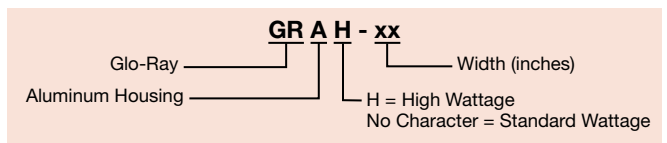

Strip Heaters



GRAHL-36 with optional Sneeze Guards and adjustable tubular stands

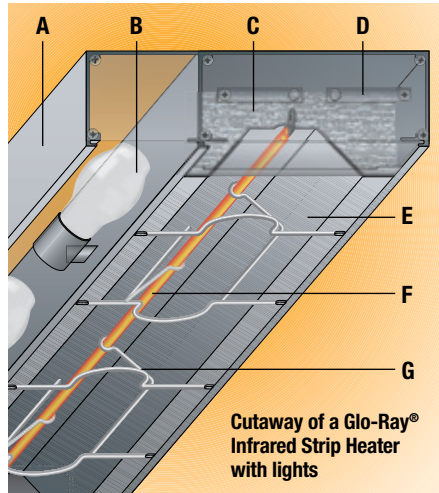

Cutaway of a Glo-Ray® Infrared Strip Heater with lights

- A** Stainless Steel or sturdy aluminum housings that do not sag, from 18" up to 144" (12') in 6" increments. Stainless Steel units available as single units without lights, up to 96" in width
- B** Shatter-resistant incandescent lights (standard on GRAL/GRAHL), optional halogen bulb available
- C** Heavy-duty insulation minimizes heat loss
- D** Standard Hanger Tabs are provided
- E** Aluminized reflector retains full heat intensity and directs more heat towards the edges of the holding surface
- F** Metal-sheathed heating element part guaranteed against burnout and breakage for two years
- G** Protective wire guard supports heating element without affecting heat distribution

Quick-Ship Program Information Inside Back Cover

ALUMINUM STRIP HEATERS with LIGHTS with CONDUIT

STAINLESS STEEL STRIP HEATERS with CONDUIT

Strip Heaters

Model	Bulbs	Width	Voltage Single Phase	Watts	Approx. Ship Weight	List Price ^o
Standard Watt						
GRAL-18	2	18"	120, 120/208 or 120/240	370	9 lbs.	\$ 818
GRAL-24	2	24"	120, 120/208 or 120/240	470	10 lbs.	853
GRAL-30	2	30"	120, 120/208 or 120/240	570	12 lbs.	948
GRAL-36	3	36"	120, 120/208 or 120/240	755	13 lbs.	1044
GRAL-42	3	42"	120, 120/208 or 120/240	855	15 lbs.	1146
GRAL-48	4	48"	120, 120/208 or 120/240	1040	17 lbs.	1245
GRAL-54	4	54"	120, 120/208 or 120/240	1165	19 lbs.	1360
GRAL-60	5	60"	120, 120/208 or 120/240	1350	21 lbs.	1479
GRAL-66	5	66"	120, 120/208 or 120/240	1460	22 lbs.	1618
GRAL-72	6	72"	120, 120/208 or 120/240	1635	24 lbs.	1803
GRAL-84 ^v	7	84"	120, 120/208 or 120/240	1920	28 lbs.	2083
GRAL-96 ^v	8	96"	120, 120/208 or 120/240	2205	32 lbs.	2364
GRAL-108	9	108"	120, 120/208 or 120/240	2390	36 lbs.	2846
GRAL-120	10	120"	120, 120/208 or 120/240	2700	40 lbs.	3121
GRAL-132	11	132"	120, 120/208 or 120/240	2980	44 lbs.	3399
GRAL-144	12	144"	120, 120/208 or 120/240	3270	48 lbs.	3680
High Watt						
GRAHL-18	2	18"	120, 120/208 or 120/240	470	8 lbs.	\$ 829
GRAHL-24	2	24"	120, 120/208 or 120/240	620	10 lbs.	864
GRAHL-30	2	30"	120, 120/208 or 120/240	780	11 lbs.	959
GRAHL-36	3	36"	120, 120/208 or 120/240	980	13 lbs.	1055
GRAHL-42	3	42"	120, 120/208 or 120/240	1130	16 lbs.	1157
GRAHL-48	4	48"	120, 120/208 or 120/240	1340	17 lbs.	1256
GRAHL-54	4	54"	120, 120/208 or 120/240	1490	19 lbs.	1371
GRAHL-60	5	60"	120, 120/208 or 120/240	1700	21 lbs.	1490
GRAHL-66 ^v	5	66"	120, 120/208 or 120/240	1860	22 lbs.	1629
GRAHL-72 ^v	6	72"	120, 120/208 or 120/240	2085	34 lbs.	1814
GRAHL-84 [^]	7	84"	120, 120/208 or 120/240	2470	28 lbs.	2094
GRAHL-96 [^]	8	96"	120, 120/208 or 120/240	2880	53 lbs.	2375
GRAHL-108	9	108"	120, 120/208 or 120/240	3040	36 lbs.	2857
GRAHL-120	10	120"	120, 120/208 or 120/240	3400	40 lbs.	3132
GRAHL-132	11	132"	120, 120/208 or 120/240	3780	44 lbs.	3410
GRAHL-144	12	144"	120, 120/208 or 120/240	4170	48 lbs.	3691

Model	Width	Voltage Single Phase	Watts	Approx. Ship Weight	List Price ^o
Standard Watt					
GR-18	18"	120, 208 or 240	250	7 lbs.	\$ 775
GR-24	24"	120, 208 or 240	350	7 lbs.	817
GR-36	36"	120, 208 or 240	575	10 lbs.	923
GR-48	48"	120, 208 or 240	800	12 lbs.	1003
GR-60	60"	120, 208 or 240	1050	15 lbs.	1135
GR-72	72"	120, 208 or 240	1275	19 lbs.	1353
GR-96 [*]	96"	120, 208 or 240	1725	24 lbs.	1639
High Watt					
GRH-18	18"	120, 208 or 240	350	8 lbs.	\$ 787
GRH-24	24"	120, 208 or 240	500	7 lbs.	828
GRH-36	36"	120, 208 or 240	800	10 lbs.	934
GRH-48	48"	120, 208 or 240	1100	13 lbs.	1014
GRH-60	60"	120, 208 or 240	1400	16 lbs.	1146
GRH-72 [*]	72"	120, 208 or 240	1725	19 lbs.	1364
GRH-96	96"	208 or 240	2400	24 lbs.	1650

^o Does not include Remote Control Enclosure (RMB), see pages 125 and 126.
^{*} Infinite Switch not available in 120V.

All Stainless Steel Models Feature:

Toggle Switch (max. 15 Amps) Location: Chef's left side.
Leads: 3' conduit with leads – server's right. NEMA 5-15P cord available on 120 volt models 72" or less with C-leg, T-leg stand or chain-hook mount. GRH-72 requires a NEMA 5-20P cord.
Dimensions: 18"-96"W x 6"D x 2 3/4"H.

Contact factory for stainless marine applications.

- ^o Does not include Remote Control Enclosure (RMB), see pages 125 and 126.
- ^v When using an Infinite Control with 120 volt model, additional switch(es) and tandem (end-to-end) elements are required, cord not available.
- [^] 120 volt models require additional switches and tandem (end-to-end) elements.

All Glo-Ray Aluminum Infrared Models with Conduit and Lights Feature:

Toggle Switch (max. 15 Amps) Location: Chef's left side – light side (unless otherwise specified).
Leads: 3' conduit with leads – server's right. NEMA 5-15P cord available on 120 volt models 72" or less with C-leg, T-leg stand or hook-chain mount. GRAHL-54, GRAHL-60, GRAHL-66 & GRAHL-72 require a NEMA 5-20P cord. GRAHL-66 & GRAHL-72 are not available with a cord.
Dimensions: 18"-144"W x 9"D x 2 3/4"H.

OPTIONS AND ACCESSORIES – PAGE 101

RECOMMENDED MOUNTING HEIGHTS – PAGE 123

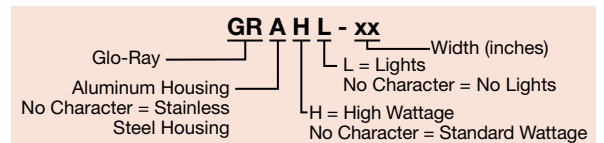



GRAHL-48
with optional
Sneeze Guard

OPTIONS (available at time of purchase only)

Designer Colors, aluminum models 18"-144" – Non-standard colors are non-returnable – Clear Anodized standard –

COLOR-6	6" Housing for GRA and GRAH models (color selection below)						per foot	\$52
COLOR-9	9" Housing for GRAL and GRAHL models (color selection below)						per foot	52
	RED	Warm Red	GRAY	Gray Granite	NAVY	Navy Blue	COPPER	Antique Copper
	BLACK	Black	WHITE	White Granite	GREEN	Hunter Green		

Gloss Finishes, aluminum models 18"-144" – Non-standard colors are non-returnable – Clear Anodized standard –

GLOSS-6	6" Housing for GRA and GRAH models (finish selection below)						per foot	\$72
GLOSS-9	9" Housing for GRAL and GRAHL models (finish selection below)						per foot	72
	RRED	Radiant Red	GGRAY	Glossy Gray	BBLACK	Bold Black		
	GGOLD	Gleaming Gold	BBLUE	Brilliant Blue				

IND. LGT	Indicator Light (Remote Control only on all Tandem Element units)		\$33
-----------------	---	--	------

Power Leads – Extended beyond standard 3' Conduit (must specify lead length) –

LEADS5	1'-5' extended Electrical Leads	\$ 43
LEADS10	6'-10' extended Electrical Leads	85
LEADS15	11'-15' extended Electrical Leads	128
LEADS20	16'-20' extended Electrical Leads	171

Sneeze Guards

9.375BP1	9¾" Sneeze Guard (aluminum models only) one side	per foot	\$114
9.375BP2	9¾" Sneeze Guard (aluminum models only) two sides	per foot	229
14BP1	14" Sneeze Guard (aluminum models only) one side	per foot	180
14BP2	14" Sneeze Guard (aluminum models only) two sides	per foot	361
HAL	60 Watt Halogen Bulb in lieu of Standard Display Light (aluminum models only)	each	102
NO BULB	No bulb option (GRAL, GRAHL models only)		No Charge
LIGHTS-ADD'L	Extra Lamps – Installed (max. two per foot less one per foot is Standard) must be ordered with remote switches only, aluminum models only	each	52
3 ANEAL REFL	Bright Annealed Reflector for Lights (aluminum models only)	per foot	43
NO CONTROL	No control included (GRA, GRAH, GRAL, GRAHL, GR, GRH models only) Requires selection of RMB2-xx control - see page 125		No Charge
BLT INF	Infinite Control Built-in in lieu of Toggle (max. 12.2 Amps) (remote installation recommended)	each	76
REM INF	Remote Infinite Switches in lieu of Toggle (max. 12.2 Amps)	each	76
REM TOG	Remote Toggle Switches (max. 15 Amps)		No Charge
RMB	Remote Control Enclosure (available in Designer Colors or Gloss Finishes) – Non-standard colors are non-returnable –		see pages 103 and 104

Stands

ATL	Adjustable Tubular Stands 10"-14" (not available in Designer Colors) – Not available with cord	1 pair	393
NTL-10, -12	Non-Adjustable Tubular Stands (specify 10" or 12" clearance) – Not available with cord	1 pair	180
NTL-14, -16	Non-Adjustable Tubular Stands (specify 14" or 16" clearance) – Not available with cord	1 pair	194
NTL-PAINT	Designer Color or Gloss Finish to match unit color for Non-Adjustable Tubular Stands – Non-standard colors are non-returnable –	1 pair	73
CL-LOW	C-Leg Stands, standard Watt – 10" clearance (for models up to 72" wide) – Only available with cord	1 pair	205
CL-HIGH	C-Leg Stands, High Watt – 13½" clearance (for models up to 72" wide) – Only available with cord	1 pair	233
TL-10	T-Leg Stands, standard Watt – 10" clearance (for models only up to 72" wide) – Only available with cord	1 pair	499
TL-13	T-Leg Stands, 13½" clearance (for models up to 72" wide) – Only available with cord	1 pair	551
TL-16	T-Leg Stands, 16" clearance (for models up to 72" wide) – Only available with cord	1 pair	584
TL-18	T-Leg Stands, 18" clearance (for models up to 72" wide) – Only available with cord	1 pair	627
CAP	Attached 6' Cord and Plug Set (120V only) on models up to 72" wide, requires standard Chain Mount Kit (two S Hooks with two 6" lengths of chain) or add optional C-leg Stands or T-leg Stands (see specific model for plug configuration)		59
CHAIN-HOOK	Two S Hooks with two 6" lengths of chain	each	22

ACCESSORIES (available for purchase at any time)

ADJ ANGLE	Adjustable Angle Brackets (GRA, GRAH models only) (see page 124 for illustration)	1 pair	\$ 45
ADJ ANGLE7	7" tall Adjustable Angle Brackets (see page 124 for illustration)	1 pair	55
GR-ANGLE	Adjustable Angle Brackets (GR models only) (see page 124 for illustration)	1 pair	45
CHAIN 1	Chain Suspension (see page 124 for illustration)	per foot	22

Chef LED Bulb 120V adjustable bulb – GRAL, GRAHL models only, all voltages –

	GRAHL requires pass-through usage only and unit must be 10" or higher from surface – bulbs must be rotated down –		
CLED-3000-120	Similar to warm Halogen light	CLED-4000-120	Similar to cool Fluorescent light
		each	205

COLORS AND FINISHES – PAGE 241

Strip Heaters



Glo-Ray® Aluminium Dual Infrared Strip Heaters

Create a deeper holding area with Glo-Ray Aluminium Dual Infrared Strip Heaters mounted side-by-side, keeping hot food at optimum serving temperatures. The pre-focused heat pattern directs heat from a metal-sheathed element across the entire holding surface. The continuous aluminum housing and heavy-duty mountings ensure the durability and quality of Hatco products.

- Ensures maximum flavor, safety and holding time
- Provides even heat distribution, no "cold spots"
- Sturdy extruded aluminum housings that do not sag, from 18" to 144" (12')
- Reflector does not blacken, maintaining a consistent heat pattern
- Protective wire guard supports heating element without affecting heat distribution
- 3" or 6" spacer available
- Heavy-duty insulation minimizes heat loss
- Additional reflector styles and lower wattage elements available, consult factory for more information



GRAH-72D with optional Designer Warm Red, 6" spacer and tandem elements

GRA-36D with standard 3" spacer

Toggle Switch: Max. 15 Amps
Infinite Switch: Max. 12.2 Amps

NOTE: 120V models may require additional switches depending on unit or wattage.

Quick-Ship Program Information Inside Back Cover

GLO-RAY ALUMINUM DUAL INFRARED STRIP HEATERS

Strip Heaters

Model	Width	Voltage		Watts	Approx. Ship Weight	List Price ^o	
		Single Phase				3" Spacer	6" Spacer
Standard Watt							
GRA-18D	18"	120, 208 or 240		500	14 lbs.	\$1277	\$1299
GRA-24D	24"	120, 208 or 240		700	16 lbs.	1332	1354
GRA-30D	30"	120, 208 or 240		900	18 lbs.	1474	1506
GRA-36D	36"	120, 208 or 240		1150	19 lbs.	1617	1649
GRA-42D	42"	120, 208 or 240		1350	23 lbs.	1759	1791
GRA-48D	48"	120, 208 or 240		1600	27 lbs.	1899	1940
GRA-54D	54"	120, 208 or 240		1850	30 lbs.	2040	2081
GRA-60D	60"	120, 208 or 240		2100	35 lbs.	2198	2261
GRA-66D	66"	120, 208 or 240		2320	36 lbs.	2417	2480
GRA-72D	72"	120, 208 or 240		2550	36 lbs.	2708	2771
GRA-84D ^v	84"	120, 208 or 240		3000	50 lbs.	3134	3219
GRA-96D ^v	96"	120, 208 or 240		3450	52 lbs.	3572	3657
GRA-108D	108"	120, 208 or 240		3700	59 lbs.	4298	4383
GRA-120D	120"	120, 208 or 240		4200	66 lbs.	4693	4825
GRA-132D ^b	132"	120, 208 or 240		4640	73 lbs.	5092	5224
GRA-144D	144"	120, 208 or 240		5100	80 lbs.	5501	5633
High Watt							
GRAH-18D	18"	120, 208 or 240		700	14 lbs.	\$1299	\$1321
✓ GRAH-24D	24"	120, 208 or 240		1000	16 lbs.	1354	1376
✓ GRAH-30D	30"	120, 208 or 240		1320	18 lbs.	1496	1528
✓ GRAH-36D	36"	120, 208 or 240		1600	19 lbs.	1639	1671
✓ GRAH-42D	42"	120, 208 or 240		1900	24 lbs.	1781	1813
✓ GRAH-48D	48"	120, 208 or 240		2200	27 lbs.	1921	1962
GRAH-54D	54"	120, 208 or 240		2500	30 lbs.	2062	2103
GRAH-60D	60"	120, 208 or 240		2800	34 lbs.	2220	2283
GRAH-66D ^v	66"	120, 208 or 240		3120	38 lbs.	2439	2502
GRAH-72D ^v	72"	120, 208 or 240		3450	36 lbs.	2730	2793
GRAH-84D ^a	84"	120, 208 or 240		4100	50 lbs.	3156	3241
GRAH-96D ^a	96"	120, 208 or 240		4800	52 lbs.	3594	3679
GRAH-108D	108"	120, 208 or 240		5000	59 lbs.	4320	4405
GRAH-120D ^b	120"	120, 208 or 240		5600	66 lbs.	4715	4847
GRAH-132D	132"	208 or 240		6240	73 lbs.	5114	5246
GRAH-144D	144"	208 or 240		6900	80 lbs.	5523	5655

^o Does not include Remote Control Enclosure (RMB), see pages 125 and 126.
^v When using an infinite control with 120 volt model, additional switch(es) and tandem (end-to-end) elements are required.
^b Available with RMB or remote switch only. Consult factory for additional charges.
^a 120 volt models require additional switches and tandem (end-to-end) elements.

All Glo-Ray Aluminium Dual Infrared Models Feature:

Toggle Switch (max. 15 Amps) Location: Chef's left side (unless otherwise specified).

Leads: 3' conduit with leads – server's right.

Dimensions: with 3" Spacer (standard): 18"-144"W x 15"D x 2 1/2"H.
with 6" Spacer: 18"-144"W x 18"D x 2 1/2"H.

OPTIONS AND ACCESSORIES – PAGE 104

RECOMMENDED MOUNTING HEIGHTS – PAGE 123

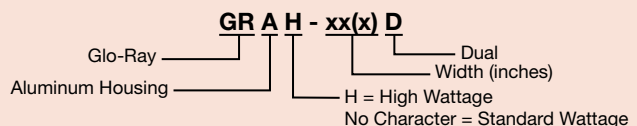



Glo-Ray® Aluminium Dual Infrared Strip Heaters *continued*

- A** Shown with optional lights (shatter-resistant incandescent lights or halogen bulbs available)
- B** Sturdy extruded aluminum housings that do not sag, from 18" up to 144" (12')
- C** Reflector does not blacken, maintaining a consistent heat pattern
- D** Standard Hanger Tab is provided for under shelf or chain installation
- E** Heavy-duty insulation minimizes heat loss
- F** Metal-sheathed heating element part guaranteed against burnout and breakage for two years
- G** Protective wire guard supports heating element without affecting heat distribution

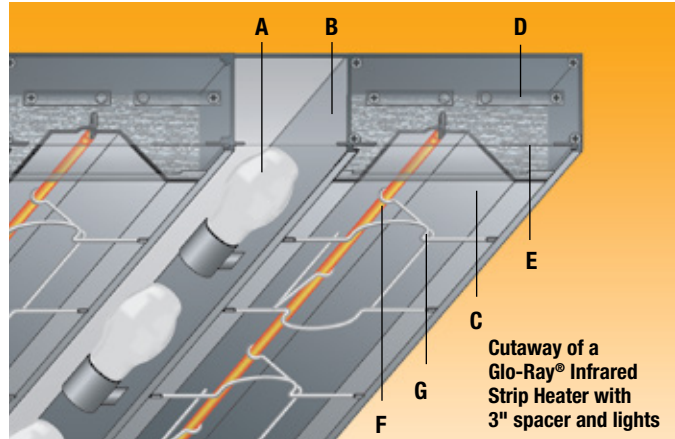

Toggle Switch: Max. 15 Amps
Infinite Switch: Max. 12.2 Amps

Quick-Ship Program Information *Inside Back Cover*

GLO-RAY ALUMINUM DUAL INFRARED STRIP HEATERS WITH LIGHTS

Model	Bulbs	Width	Voltage	Watts	Approx. Ship Weight	List Price ^o	
			Single Phase			3" Spacer	6" Spacer
Standard Watt							
GRAL-18D	2	18"	120, 120/208 or 120/240	620	14 lbs.	\$1419	\$1441
GRAL-24D	2	24"	120, 120/208 or 120/240	820	16 lbs.	1466	1488
GRAL-30D	2	30"	120, 120/208 or 120/240	1020	19 lbs.	1638	1670
GRAL-36D	3	36"	120, 120/208 or 120/240	1330	22 lbs.	1810	1842
GRAL-42D	3	42"	120, 120/208 or 120/240	1530	25 lbs.	1989	2021
GRAL-48D [▲]	4	48"	120, 120/208 or 120/240	1840	30 lbs.	2171	2212
GRAL-54D [▲]	4	54"	120, 120/208 or 120/240	2090	34 lbs.	2362	2403
GRAL-60D [▲]	5	60"	120, 120/208 or 120/240	2400	35 lbs.	2570	2633
GRAL-66D [▲]	5	66"	120, 120/208 or 120/240	2620	39 lbs.	2815	2878
GRAL-72D [▲]	6	72"	120, 120/208 or 120/240	2910	42 lbs.	3150	3213
GRAL-84D ^{▼▲}	7	84"	120, 120/208 or 120/240	3420	50 lbs.	3646	3731
GRAL-96D ^{▼▲}	8	96"	120, 120/208 or 120/240	3930	56 lbs.	4145	4230
GRAL-108D ^{▲∞}	9	108"	120, 120/208 or 120/240	4240	64 lbs.	4926	5011
GRAL-120D ^{▲∞}	10	120"	120, 120/208 or 120/240	4800	72 lbs.	5391	5523
GRAL-132D ^{▲∞}	11	132"	120, 120/208 or 120/240	5300	79 lbs.	5865	5997
GRAL-144D ^{▲∞}	12	144"	120, 120/208 or 120/240	5820	86 lbs.	6343	6475
High Watt							
GRAHL-18D	2	18"	120, 120/208 or 120/240	820	14 lbs.	\$1441	\$1463
✓ GRAHL-24D	2	24"	120, 120/208 or 120/240	1120	16 lbs.	1488	1510
✓ GRAHL-30D	2	30"	120, 120/208 or 120/240	1440	19 lbs.	1660	1692
✓ GRAHL-36D [▲]	3	36"	120, 120/208 or 120/240	1780	22 lbs.	1832	1864
GRAHL-42D [▲]	3	42"	120, 120/208 or 120/240	2080	25 lbs.	2011	2043
✓ GRAHL-48D [▲]	4	48"	120, 120/208 or 120/240	2440	30 lbs.	2193	2234
GRAHL-54D [▲]	4	54"	120, 120/208 or 120/240	2740	33 lbs.	2384	2425
GRAHL-60D [▲]	5	60"	120, 120/208 or 120/240	3100	37 lbs.	2592	2655
GRAHL-66D ^{▼▲}	5	66"	120, 120/208 or 120/240	3420	38 lbs.	2837	2900
GRAHL-72D ^{▼▲}	6	72"	120, 120/208 or 120/240	3810	42 lbs.	3172	3235
GRAHL-84D ^{▲∞}	7	84"	120, 120/208 or 120/240	4520	50 lbs.	3668	3753
GRAHL-96D ^{▲∞}	8	96"	120, 120/208 or 120/240	5280	54 lbs.	4167	4252
GRAHL-108D ^{▲∞}	9	108"	120, 120/208 or 120/240	5540	64 lbs.	4948	5033
GRAHL-120D ^{▲∞}	10	120"	120, 120/208 or 120/240	6200	72 lbs.	5413	5545
GRAHL-132D [∞]	11	132"	120, 120/208 or 120/240	6900	79 lbs.	5887	6019
GRAHL-144D [∞]	12	144"	120/208 or 120/240	7620	86 lbs.	6365	6497

▼ When using an infinite control with 120 volt model, additional switch(es) and tandem (end-to-end) elements required.
 ▲ 120 volt models may require additional switches (available with remote switches only).
 ∞ Glo-Ray models 108"-144" (2743-3658 mm) and 120V models of GRAH(L)-84D and GRAH(L)-96D contain tandem (end-to-end) elements that may be individually controlled.

All Glo-Ray Aluminum Dual Models with Lights Feature:
 Toggle Switch (max. 15 Amps) Location: Chef's left side (unless otherwise specified).
 Leads: 3' conduit with leads – server's right.
 Dimensions: with 3" Spacer (standard): 15"D x 2 1/2"H.
 with 6" Spacer: 18"D x 2 1/2"H.

OPTIONS AND ACCESSORIES – PAGE 104
RECOMMENDED MOUNTING HEIGHTS – PAGE 123

NOTE: For multiple circuit control options used with optional Tubular Stand Supports (ATL or NTL), the power supply may need to be located somewhere other than through the Tubular Stand. Consult factory for details.

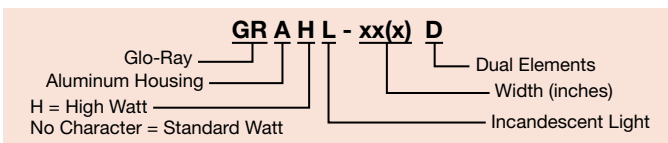

Strip Heaters



A series of GRAH-60D models

Strip Heaters

OPTIONS (available at time of purchase only)

Designer Colors, aluminum models 18"-144" – Non-standard colors are non-returnable – Clear Anodized Standard –

COLOR-15, -18	15" and 18" Housings for GRA, GRAH, GRAL and GRAHL Dual models (Clear Anodized Standard)						per foot	\$74
RED	Warm Red	GRAY	Gray Granite	NAVY	Navy Blue	COPPER	Antique Copper	
BLACK	Black	WHITE	White Granite	GREEN	Hunter Green			

Gloss Finishes, aluminum models 18"-144" – Non-standard colors are non-returnable – Clear Anodized Standard –

GLOSS-15, -18	15" and 18" Housings for GRA, GRAH, GRAL and GRAHL Dual models (Clear Anodized Standard)						per foot	\$74
RRED	Radiant Red	GGRAY	Glossy Gray	BBLACK	Bold Black			
GGOLD	Gleaming Gold	BBLUE	Brilliant Blue					
IND. LGT	Indicator Light (remote only)							\$33

Power Leads – Extended beyond Standard 3' Conduit (must specify lead length) –

LEADS5	1'-5' extended Electrical Leads	\$ 43
LEADS10	6'-10' extended Electrical Leads	85
LEADS15	11'-15' extended Electrical Leads	128
LEADS20	16'-20' extended Electrical Leads	171

9.375BP1	9 $\frac{3}{8}$ " Sneeze Guard, one side	per foot	\$114
9.375BP2	9 $\frac{3}{8}$ " Sneeze Guard, two sides	per foot	229
14BP1	14" Sneeze Guard, one side	per foot	180
14BP2	14" Sneeze Guard, two sides	per foot	361

HAL	60 Watt Halogen Bulb in lieu of Standard Display Light	each	102
------------	--	-------------	------------

NO BULB	No bulb option (GRAL-xxD, GRAHL-xxD models only)	No Charge
----------------	--	------------------

LIGHTS-ADD'L	Extra Lamps – Installed (maximum two per foot less one – one per foot is Standard)	each	52
---------------------	--	-------------	-----------

3 ANEAL REFL	Bright Annealed Reflector for lights with 3" Spacer	per foot	43
---------------------	---	-----------------	-----------

6 ANEAL REFL	Bright Annealed Reflector for lights with 6" Spacer	per foot	63
---------------------	---	-----------------	-----------

NO CONTROL	No control included (GRA, GRAH, GRAL, GRAHL-xxD models only) Requires selection of RMB2-xx control (see page 125)	No Charge
-------------------	---	------------------

REM INF	Remote Infinite Switches (max. 12.2 Amps)	each	76
----------------	---	-------------	-----------

REM TOG	Remote Toggle Switches (max. 15 Amps)	No Charge
----------------	---------------------------------------	------------------

RMB	Remote Control Enclosure (available in Designer Colors or Gloss Finishes) – Non-standard colors are non-returnable – Clear Anodized Standard –	see page 125 and 126
------------	--	-----------------------------

ATL-D	Adjustable Tubular Stands 10"-14" (not available in Designer Colors)	2 pair	\$784
--------------	--	---------------	--------------

NTL-10-D, -12-D	Non-Adjustable Tubular Stands (specify 10" or 12" clearance)	2 pair	361
------------------------	--	---------------	------------

NTL-14-D, -16-D	Non-Adjustable Tubular Stands (specify 14" or 16" clearance)	2 pair	387
------------------------	--	---------------	------------

NTL-PAINT-D	Designer Color or Gloss Finish for Non-Adjustable Tubular Stands to match unit color – Non-Standard colors are non-returnable –	2 pair	146
--------------------	---	---------------	------------

ACCESSORIES (available for purchase at any time)

ADJ ANGLE-D	Adjustable Angle Brackets for Dual models (see page 124 for illustration)	2 pair	\$ 91
--------------------	---	---------------	--------------

ADJ ANGLE7-D	7" tall Adjustable Angle Brackets for Dual models (see page 124 for illustration)	2 pair	110
---------------------	---	---------------	------------

CHAIN 1	Chain Suspension (see page 124 for illustration)	per foot	22
----------------	--	-----------------	-----------

Chef LED 120V adjustable bulb – GRAL-xxD, GRAHL-xxD models only, all voltages – pass-through usage only –

	GRAL-xxD must be 15" or higher from surface, GRAHL-xxD must be 18" or higher from surface as pass through – Bulbs must be rotated down –		
--	--	--	--

CLED-3000-120	Similar to warm Halogen light	CLED-4000-120	Similar to cool Fluorescent light	each	205
----------------------	-------------------------------	----------------------	-----------------------------------	-------------	------------

COLORS AND FINISHES – PAGE 241



Glo-Ray® Designer Aluminum Infrared Strip Heaters

Hatco Glo-Ray Designer Aluminum Infrared Strip Heaters safely keep all hot foods at optimum serving temperatures longer. This modern design is ideal for front-of-the-house use. Units are offered in continuous housings, up to 84" (7'), are available in Designer Colors to match most décors and include 14" Designer non-adjustable stands.

- Pre-focused heat maintains safe serving temperatures longer without continuing to cook the food
- Available in widths from 21½" to 87½"
- Available in a variety of models, configurations, colors and accessories to provide unlimited flexibility
- Black corner caps and inset panels standard
- Optional coated shatter-resistant incandescent or halogen lights enhance product displays while safeguarding food from bulb breakage
- Optional Sneeze Guards
- Additional reflector styles and lower wattage elements available, consult factory for more information



GR2AH-36 with Designer non-adjustable stands (NTL) and optional Designer Warm Red inset panels

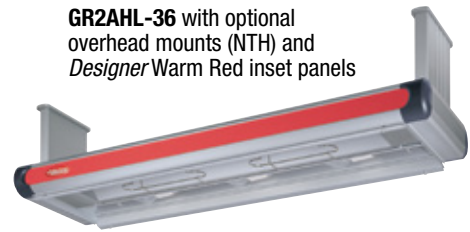

GR2AHL-36 with optional overhead mounts (NTH) and optional Designer Warm Red inset panels

Toggle Switch: Max. 15 Amps
Infinite Switch: Max. 12.2 Amps

GLO-RAY DESIGNER ALUMINUM INFRARED STRIP HEATERS (must specify and add price of RMB)

Model [Ⓜ]	Width	Watts	Approx. Ship Weight [Ⓞ]	List Price [Ⓞ]
Standard Watt				
GR2A-18	21½"	250	19 lbs.	\$2069
GR2A-24	27½"	350	20 lbs.	2150
GR2A-30	33½"	450	27 lbs.	2237
GR2A-36	39½"	575	37 lbs.	2322
GR2A-42	45½"	675	38 lbs.	2412
GR2A-48	51½"	800	43 lbs.	2499
GR2A-54	57½"	925	43 lbs.	2592
GR2A-60	63½"	1050	40 lbs.	2711
GR2A-66	69½"	1160	40 lbs.	2833
GR2A-72	75½"	1275	42 lbs.	3007
GR2A-84'	87½"	1500	46 lbs.	3749
High Watt				
GR2AH-18	21½"	350	20 lbs.	\$2080
GR2AH-24	27½"	500	20 lbs.	2161
GR2AH-30	33½"	660	27 lbs.	2248
GR2AH-36	39½"	800	27 lbs.	2333
GR2AH-42	45½"	950	34 lbs.	2423
GR2AH-48	51½"	1100	27 lbs.	2510
GR2AH-54	57½"	1250	43 lbs.	2603
GR2AH-60	63½"	1400	40 lbs.	2722
GR2AH-66'	69½"	1560	40 lbs.	2844
GR2AH-72'	75½"	1725	42 lbs.	3018
GR2AH-84'	87½"	2050	46 lbs.	3489

- Ⓜ When no color is specified, color inset panels and corner caps will be black.
- Ⓞ Does not include Remote Control Enclosure (RMB).
- Ⓞ Does not include Remote Control Enclosure (RMB). Must choose RMB (see pages 125 and 126).
- ⚡ When using an infinite control with 120 volt model, additional switch(es) and tandem (end-to-end) elements required.
- ⚡ 120 volt models require additional switches and tandem (end-to-end) elements.

All Glo-Ray Designer Aluminum Infrared Models Feature:

Voltage: 120, 208 or 240, single phase only.
Switch Location: Remote Control Enclosure (RMB) only (see pages 125 and 126).
Leads: 5' leads through ½" conduit in leg cavity.
Dimensions without stands: 21½"-87½"W x 9"D x 3½"H.

OPTIONS AND ACCESSORIES – PAGE 107
RECOMMENDED MOUNTING HEIGHTS – PAGE 123

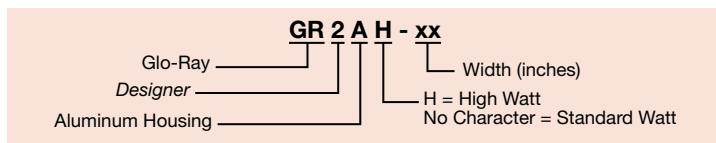

Strip Heaters



Glo-Ray® Designer Aluminum Infrared Strip Heaters with Lights

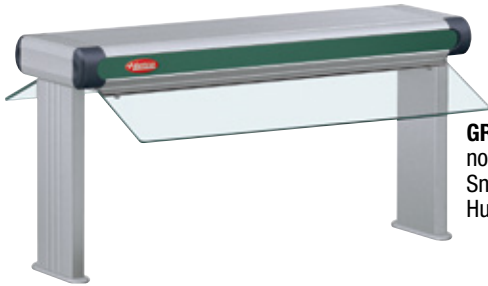

GR2AHL-24 with Designer non-adjustable stands optional Sneeze Guards and Designer Hunter Green inset panels

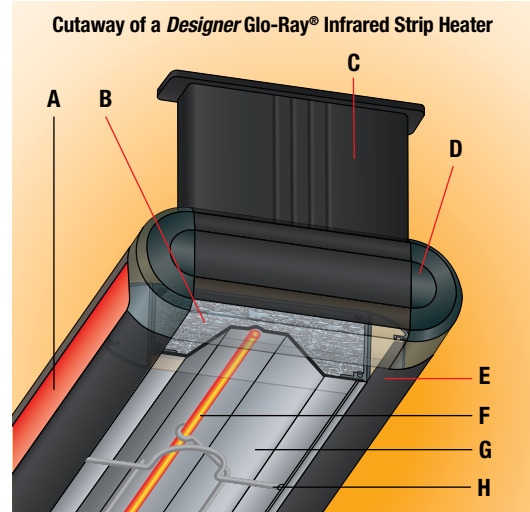

- A** Choice of seven Designer Color inset panels and attractive styling for front-of-the-house applications
- B** Heavy-duty insulation minimizes heat loss
- C** Non-adjustable stand conceals the power wiring, available for counter or overhead mounting
- D** Accent color corners available in Dark Gray or Black (standard)
- E** Sturdy aluminium extrusion construction; available in Clear Anodized aluminum finish or one of seven Designer Colors for housings (shown in optional Designer Black)
- F** Metal-sheathed heating element part guaranteed against burnout and breakage for two years
- G** Aluminized Reflectors won't discolor, so heat can be reflected and directed to the food product being held
- H** Protective wire guard supports heating element without affecting heat distribution

GLO-RAY DESIGNER ALUMINUM INFRARED STRIP HEATERS with LIGHTS (must specify and add price of RMB)

Model [®]	No. of Bulbs	Width	Watts	Approx. Ship Weight [○]	List Price [°]
Standard Watt					
GR2AL-18	2	21½"	370	24 lbs.	\$2355
GR2AL-24	2	27½"	470	24 lbs.	2450
GR2AL-30	2	33½"	570	29 lbs.	2591
GR2AL-36	3	39½"	755	33 lbs.	2747
GR2AL-42	3	45½"	855	35 lbs.	2906
GR2AL-48	4	51½"	1040	36 lbs.	3070
GR2AL-54	4	57½"	1165	49 lbs.	3240
GR2AL-60	5	63½"	1350	54 lbs.	3413
GR2AL-66	5	69½"	1460	57 lbs.	3605
GR2AL-72	6	75½"	1635	58 lbs.	3842
GR2AL-84 [✓]	7	87½"	1920	62 lbs.	4156
High Watt					
GR2AHL-18	2	21½"	470	26 lbs.	\$2366
GR2AHL-24	2	27½"	620	24 lbs.	2461
GR2AHL-30	2	33½"	780	29 lbs.	2602
GR2AHL-36	3	39½"	980	33 lbs.	2758
GR2AHL-42	3	45½"	1130	35 lbs.	2917
GR2AHL-48	4	51½"	1340	48 lbs.	3081
GR2AHL-54	4	57½"	1490	49 lbs.	3251
GR2AHL-60	5	63½"	1700	54 lbs.	3424
GR2AHL-66 [✓]	5	69½"	1860	57 lbs.	3616
GR2AHL-72 [✓]	6	75½"	2085	58 lbs.	3853
GR2AHL-84 [✓]	7	87½"	2470	62 lbs.	4167

[®] When no color is specified, color inset panels and corner caps will be black.
[○] Does not include Remote Control Enclosure (RMB).
[°] Does not include Remote Control Enclosure (RMB). Must choose RMB (see pages 125 and 126).
[✓] When using an infinite control with 120 volt model, additional switch(es) and tandem (end-to-end) elements required.
[✓] 120 volt models require additional switches and tandem (end-to-end) elements.

All Glo-Ray Designer Aluminum Infrared Models with Lights Feature:

Voltage: 120, 120/208 or 120/240, single phase only.
Switch Location: Remote Control Enclosure (RMB) only (see pages 125 and 126).
Leads: 5' leads through ½" conduit in leg cavity.
Dimensions without stands: 21½"-87½"W x 12"D x 3½"H.

OPTIONS AND ACCESSORIES – PAGE 107
RECOMMENDED MOUNTING HEIGHTS – PAGE 123

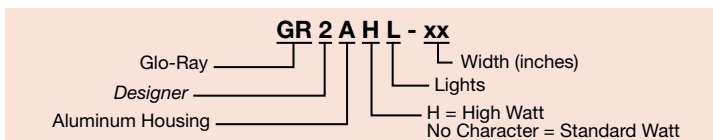

Strip Heaters



GR2AHL-84 with standard *Designer* non-adjustable stands and optional *Designer* Black and Sneeze Guards

Strip Heaters

OPTIONS (available at time of purchase only)

Designer Colors, aluminum models 21½" - 87½" (includes stands) – Non-standard colors are non-returnable – Clear Anodized standard –

COLOR-6	9" Housing for GR2A and GR2AH models						per foot	\$52	
	RED	Warm Red	GRAY	Gray Granite	NAVY	Navy Blue	COPPER	Antique Copper	
	BLACK	Black	WHITE	White Granite	GREEN	Hunter Green			
COLOR-9	12" Housing for GR2AL and GR2AHL models						per foot	52	
	RED	Warm Red	GRAY	Gray Granite	NAVY	Navy Blue	COPPER	Antique Copper	
	BLACK	Black	WHITE	White Granite	GREEN	Hunter Green			
Designer Inset Panel Colors – Black standard – Non-standard colors are non-returnable –								No Charge	
	RED	Warm Red	WHITE	White Granite	GREEN	Hunter Green			
	GRAY	Gray Granite	NAVY	Navy Blue	COPPER	Antique Copper			
Designer Corner Caps – Black standard –								No Charge	
	DKGRAY	Dark Gray Corner Caps						No Charge	
NO CONTROL	No control included (GR2A, GR2AH, GR2AL, GR2AHL models only), requires selection of RMB2-xx control – see page 125							No Charge	
RMB	Must choose Remote Control Enclosure (not included)						see pages	125 and 126	
Designer Remote Control Enclosures – Non-standard colors are non-returnable – Clear Anodized standard –								see pages	125 and 126
RMB-COLOR	Remote Control Enclosure Housing in <i>Designer</i> Color							see pages	125 and 126
	RED	Warm Red	GRAY	Gray Granite	NAVY	Navy Blue	COPPER	Antique Copper	
	BLACK	Black	WHITE	White Granite	GREEN	Hunter Green			
7.5BP1	7½" Sneeze Guard one side						per foot	\$114	
7.5BP2	7½" Sneeze Guard two sides						per foot	229	
14BP1	14" Sneeze Guard one side						per foot	180	
14BP2	14" Sneeze Guard two sides						per foot	361	
NTL2-10, -12, -16	<i>Designer</i> Color Non-Adjustable Stands to match unit color: 10", 12" or 16" in lieu of 14" standard Stands – Non-standard colors are non-returnable –						No Charge		
NTH2-4	4" <i>Designer</i> Color Overhead Mounts in lieu of 14" standard Legs to match unit color – Non-standard colors are non-returnable –						No Charge		
HAL	60 Watt Halogen Bulb in lieu of standard Display Light						each	102	
NO BULB	No bulb option (GR2AL, GR2AHL models only)							102	
LIGHTS-ADD'L	Extra Lamps – Installed (max. two per ft. less one – one per ft. is standard)						each	52	
Power Leads (must specify lead length) –									
LEADS5	1'-5' extended Electrical Leads							\$ 43	
LEADS10	6'-10' extended Electrical Leads							85	
LEADS15	11'-15' extended Electrical Leads							128	
LEADS20	16'-20' extended Electrical Leads							171	

ACCESSORIES (available for purchase at any time)

Chef LED 120V adjustable bulb – GR2AL, GR2AHL models only, all voltages –

GR2AHL requires pass-through usage only and unit must be 10" or higher from surface – bulbs must be rotated down

CLED-3000-120 Similar to warm Halogen light **CLED-4000-120** Similar to cool Fluorescent light **each \$205**

COLORS AND FINISHES – PAGE 241

CLED-3000 and -4000
Accessory





Glo-Ray® Designer Aluminum Infrared Dual Strip Heaters

Glo-Ray Designer Aluminum Infrared Dual Strip Heaters allow side-by-side mounting of two warmers to provide a deeper holding area, keeping hot food at optimum serving temperatures. These modern front-of-the-house warmers have 3" spacers standard with optional 6" spacers. Units are available in Designer colors to match most décors.

- Sturdy continuous aluminum housings eliminate sagging
- Pre-focused heat pattern directs heat from a tubular element to bathe the entire holding surface, holding food safely
- Available in widths from 21½" to 87½"
- Variety of models, configurations, colors and accessories provide unlimited flexibility. Non-standard colors are non-returnable
- Optional Sneeze Guards that meet food safety standards can be ordered for display areas and buffet lines
- Optional shatter-resistant incandescent lights available
- Black corner caps and inset panels standard
- Additional reflector styles and lower wattage elements available, consult factory for more information



GR2AH-24D with standard Designer non-adjustable stands, optional Sneeze Guards and optional Designer Navy Blue inset panels



GR2AHL-48D with standard Designer non-adjustable stands and optional Designer Warm Red inset panels

Toggle Switch: Max. 15 Amps
Infinite Switch: Max. 12.2 Amps

GLO-RAY DESIGNER ALUMINUM INFRARED DUAL STRIP HEATERS (must specify and add price of RMB)

Model [®]	Width	Watts	Approx. Ship Weight [○]	List Price [○]	
				3" Spacer	6" Spacer
Standard Watt					
GR2A-18D	21½"	500	28 lbs.	\$2993	\$3015
GR2A-24D	27½"	700	31 lbs.	3110	3132
GR2A-30D	33½"	900	37 lbs.	3288	3320
GR2A-36D	39½"	1150	37 lbs.	3471	3503
GR2A-42D	45½"	1350	41 lbs.	3658	3690
GR2A-48D	51½"	1600	45 lbs.	3843	3884
GR2A-54D	57½"	1850	52 lbs.	4033	4074
GR2A-60D	63½"	2100	60 lbs.	4271	4334
GR2A-66D	69½"	2320	70 lbs.	4514	4577
GR2A-72D	75½"	2550	63 lbs.	4873	4936
GR2A-84D	87½"	3000	84 lbs.	5299	5384
High Watt					
GR2AH-18D	21½"	700	30 lbs.	\$3015	\$3037
GR2AH-24D	27½"	1000	29 lbs.	3132	3154
GR2AH-30D	33½"	1320	37 lbs.	3310	3342
GR2AH-36D	39½"	1600	37 lbs.	3493	3525
GR2AH-42D	45½"	1900	48 lbs.	3680	3712
GR2AH-48D	51½"	2200	55 lbs.	3865	3906
GR2AH-54D	57½"	2500	60 lbs.	4055	4096
GR2AH-60D	63½"	2800	55 lbs.	4293	4356
GR2AH-66D	69½"	3120	64 lbs.	4536	4599
GR2AH-72D	75½"	3450	61 lbs.	4895	4958
GR2AH-84D	87½"	4100	95 lbs.	5321	5406

GLO-RAY DESIGNER ALUMINUM INFRARED DUAL STRIP HEATERS with LIGHTS (must specify and add price of RMB)

Model [®]	No. of Bulbs	Width	Watts	Approx. Ship Weight [○]	List Price [○]	
					3" Spacer	6" Spacer
Standard Watt						
GR2AL-18D	2	21½"	620	32 lbs.	\$3135	\$3157
GR2AL-24D	2	27½"	820	32 lbs.	3253	3275
GR2AL-30D	2	33½"	1020	35 lbs.	3460	3492
GR2AL-36D	3	39½"	1330	40 lbs.	3685	3717
GR2AL-42D	3	45½"	1530	46 lbs.	3898	3930
GR2AL-48D	4	51½"	1840	47 lbs.	4117	4158
GR2AL-54D	4	57½"	2090	50 lbs.	4339	4380
GR2AL-60D	5	63½"	2400	55 lbs.	4628	4691
GR2AL-66D	5	69½"	2620	67 lbs.	4923	4986
GR2AL-72D	6	75½"	2910	75 lbs.	5322	5385
GR2AL-84D	7	87½"	3420	82 lbs.	5853	5938
High Watt						
GR2AHL-18D	2	21½"	820	32 lbs.	\$3157	\$3179
GR2AHL-24D	2	27½"	1120	32 lbs.	3275	3297
GR2AHL-30D	2	33½"	1440	35 lbs.	3482	3514
GR2AHL-36D	3	39½"	1780	40 lbs.	3707	3739
GR2AHL-42D	3	45½"	2080	46 lbs.	3920	3952
GR2AHL-48D	4	51½"	2440	47 lbs.	4139	4180
GR2AHL-54D	4	57½"	2740	50 lbs.	4361	4402
GR2AHL-60D	5	63½"	3100	55 lbs.	4650	4713
GR2AHL-66D	5	69½"	3420	67 lbs.	4945	5008
GR2AHL-72D	6	75½"	3810	75 lbs.	5344	5407
GR2AHL-84D	7	87½"	4520	82 lbs.	5875	5960

- Ⓜ When no color is specified, color inset panels and corner caps will be black.
- Does not include Remote Control Enclosure (RMB).
- Does not include Remote Control Enclosure (RMB). Must choose RMB, see pages 125, 126.
- ⚡ Infinite switch requires tandem for 120 volt GR2AH-66D & -72D.
- ⚡ 120 volt requires tandem for GR2AH-84D.

- Ⓜ When no color is specified, color inset panels and corner caps will be black.
- Does not include Remote Control Enclosure (RMB).
- Does not include Remote Control Enclosure (RMB). Must choose RMB, see pages 125, 126.
- ⚡ Infinite switch requires tandem for 120 volt GR2AHL-66D & -72D.
- ⚡ 120 volt requires tandem for GR2AHL-84D.

All Glo-Ray Designer Aluminum Infrared Dual Models Feature:
Voltage: Models Without Lights: 120, 208 or 240, single phase only.
Switch Location: Remote Control Enclosure (RMB) only (see pages 125, 126).
Leads: 5' leads through ½" conduit in leg cavity.
Dimensions: with 3" Spacer (standard): 21½"-87½"W x 18"D x 3½"H.
 with 6" Spacer: 21½"-87½"W x 21"D x 3½"H.

All Glo-Ray Designer Aluminum Infrared Dual with Lights Models Feature:
Voltage: Models With Lights: 120, 120/208 or 120/240, single phase only.
Switch Location: Remote Control Enclosure (RMB) only (see pages 125, 126).
Leads: 5' leads through ½" conduit in leg cavity.
Dimensions: with 3" Spacer (standard): 21½"-87½"W x 18"D x 3½"H.
 with 6" Spacer: 21½"-87½"W x 21"D x 3½"H.

OPTIONS AND ACCESSORIES – PAGE 109 RECOMMENDED MOUNTING HEIGHTS – PAGE 123

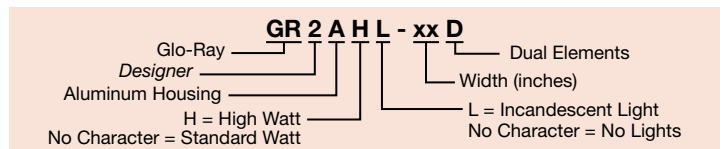



GR2AHL-30D

OPTIONS (available at time of purchase only)

Designer Colors, aluminum models 21½"- 87½" (includes stands) – Non-standard colors are non-returnable – Clear Anodized standard –

COLOR-15, -18	15" and 18" Housings for GR2A, GR2AH, GR2AL and GR2AHL Dual models						per foot	\$74
RED	Warm Red	GRAY	Gray Granite	NAVY	Navy Blue	COPPER	Antique Copper	
BLACK	Black	WHITE	White Granite	GREEN	Hunter Green			

Designer Inset Panel Colors – Black standard –

RED	Warm Red	WHITE	White Granite	GREEN	Hunter Green		No Charge
GRAY	Gray Granite	NAVY	Navy Blue	COPPER	Antique Copper		

Designer Corner Caps – Black standard –

DKGRAY	Dark Gray Corner Caps						No Charge
---------------	-----------------------	--	--	--	--	--	-----------

NO CONTROLS No control included (GR2A, GR2AH, GR2AL, GR2AHL-xxD models only), requires selection of RMB2-xx control – see page 125 **No Charge**

RMB Remote Control Enclosure – available in *Designer Colors* or *Gloss Finishes* – Non-standard colors are non-returnable – Clear Anodized standard – (must choose a Remote Control Enclosure - not included) **see pages 125 and 126**

RED	Warm Red	GRAY	Gray Granite	NAVY	Navy Blue	COPPER	Antique Copper
BLACK	Black	WHITE	White Granite	GREEN	Hunter Green		
RRED	Radiant Red	GGRAY	Glossy Gray	BBLACK	Bold Black		
GGOLD	Gleaming Gold	BBLUE	Brilliant Blue				

7.5BP1	7½" Sneeze Guard one side						per foot	\$114
7.5BP2	7½" Sneeze Guard two sides						per foot	229
14BP1	14" Sneeze Guard one side						per foot	180
14BP2	14" Sneeze Guard two sides						per foot	361

NTL2-10, -12, -16 *Designer* Non-Adjustable Stands: 10", 12" or 16" in lieu of 14" standard Stands to match unit color – Non-standard colors are non-returnable – **No Charge**

NTH2-4 4" *Designer* Overhead Mounts in lieu of 14" standard Stands to match unit color – Non-standard colors are non-returnable – **No Charge**

HAL 60 Watt Halogen Bulb in lieu of standard Display Light **each \$102**

NO BULB No bulb option (GR2AL-xxD, GR2AHL-xxD models only) **No Charge**

LIGHTS-ADD'L Extra Lamps – Installed (max. two per ft. less one – one per ft. is standard) **each 52**

Power Leads (must specify lead length) –

LEADS5	1'-5' extended Electrical Leads	\$ 43
LEADS10	6'-10' extended Electrical Leads	85
LEADS15	11'-15' extended Electrical Leads	128
LEADS20	16'-20' extended Electrical Leads	171

ACCESSORIES (available for purchase at any time)

Chef LED 120V adjustable bulb – GR2AL-xxD, GR2AHL-xxD models only, all voltages –

GR2AL-xxD requires pass-through usage only and unit must be 15" or higher from surface

GR2AHL-xxD requires pass-through usage only and unit must be 18" or higher from surface

Bulbs must be rotated down –

LED-3000-120 Similar to warm Halogen light **CLED-4000-120** Similar to cool Fluorescent light **each \$205**

COLORS AND FINISHES – PAGE 241

Strip Heaters



Glo-Ray® Aluminium Max Watt Infrared Strip Heaters

Safely hold the temperature of your product without drying out or further cooking food with Hatco's Glo-Ray Aluminium Max Watt Infrared Strip Heaters. The end result is hot, fresh food that's ready-to-serve. The continuous aluminum housing and heavy-duty mountings ensure the durability and quality of Hatco products.

- Features 25% greater wattage output than Glo-Ray high watt by comparison with single units varying in watts from 450 to 4150 watts; and units with lights varying from 570 to 4870 watts
- Sturdy extruded aluminum housings that do not sag, from 18" to 72" in 6" increments and 84" to 144" in 12" increments
- Protective wire guards under heating element
- Available options include Built-in Toggle Control, Toggle Control Remote Box, Electronic Infinite Control Remote Box or loose Remote Controls.

- Shatter-resistant incandescent lights (standard on GRAML models) enhance product display while safeguarding food products from bulb breakage. An optional halogen bulb may be used in lieu of incandescents
- Additional reflector styles available, consult factory for more information
- Heavy-duty insulation minimizes heat loss



GRAM-36



GRAML-36 with shatter-resistant incandescent lights and standard angle brackets

GLO-RAY ALUMINUM MAX WATT INFRARED STRIP HEATERS

GLO-RAY ALUMINUM MAX WATT INFRARED STRIP HEATERS with LIGHTS

Model	Width	Voltage Single Phase	Watts	Approx. Ship Weight [▲]	List Price [◎]
Max Watt					
GRAM-18	18"	120, 208 or 240	450	9 lbs.	\$ 798
GRAM-24	24"	120, 208 or 240	650	10 lbs.	825
GRAM-30	30"	120, 208 or 240	825	10 lbs.	865
GRAM-36	36"	120, 208 or 240	1000	12 lbs.	887
GRAM-42	42"	120, 208 or 240	1175	12 lbs.	927
GRAM-48	48"	120, 208 or 240	1300	15 lbs.	968
GRAM-54	54"	120, 208 or 240	1500	16 lbs.	1012
GRAM-60	60"	120, 208 or 240	1700	17 lbs.	1058
GRAM-66 [✓]	66"	120, 208 or 240	1875	21 lbs.	1160
GRAM-72 [✓]	72"	120, 208 or 240	2075	21 lbs.	1266
GRAM-84 [Ⓢ]	84"	120, 208 or 240	2400	22 lbs.	1404
GRAM-96 [Ⓢ]	96"	120, 208 or 240	2675	25 lbs.	1548
GRAM-108 [∞]	108"	208 or 240	3000	23 lbs.	1810
GRAM-120 [∞]	120"	208 or 240	3400	26 lbs.	1939
GRAM-132 [∞]	132"	208 or 240	3750	30 lbs.	2061
GRAM-144 [∞]	144"	208 or 240	4150	33 lbs.	2194

Model	Bulbs	Width	Voltage Single Phase	Watts	Approx. Ship Weight [▲]	List Price [◎]
Max Watt						
GRAML-18	2	18"	120, 120/208, or 120/240	570	10 lbs.	\$1110
GRAML-24	2	24"	120, 120/208 or 120/240	770	13 lbs.	1134
GRAML-30	2	30"	120, 120/208 or 120/240	945	15 lbs.	1242
GRAML-36	3	36"	120, 120/208 or 120/240	1180	15 lbs.	1322
GRAML-42	3	42"	120, 120/208 or 120/240	1355	19 lbs.	1402
GRAML-48	4	48"	120, 120/208 or 120/240	1540	20 lbs.	1504
GRAML-54	4	54"	120, 120/208 or 120/240	1740	24 lbs.	1616
GRAML-60 [Ⓢ]	5	60"	120, 120/208 or 120/240	2000	22 lbs.	1729
GRAML-66 [Ⓢ] ✓	5	66"	120, 120/208 or 120/240	2175	25 lbs.	1948
GRAML-72 [Ⓢ] ✓	6	72"	120, 120/208 or 120/240	2435	29 lbs.	2116
GRAML-84 [Ⓢ] Ⓢ	7	84"	120, 120/208 or 120/240	2820	32 lbs.	2376
GRAML-96 [Ⓢ] Ⓢ	8	96"	120, 120/208 or 120/240	3155	37 lbs.	2636
GRAML-108 [∞] Ⓢ	9	108"	120/208 or 120/240	3540	36 lbs.	3072
GRAML-120 [∞] Ⓢ	10	120"	120/208 or 120/240	4000	40 lbs.	3324
GRAML-132 [∞] Ⓢ	11	132"	120/208 or 120/240	4410	44 lbs.	3587
GRAML-144 [∞] Ⓢ	12	144"	120/208 or 120/240	4870	48 lbs.	3855

- ▲ Add 2-8 lbs. depending on Remote Control Enclosure (RMB).
- ◎ Includes either Remote Control Enclosure (RMB) with toggle switch(es) and indicator light(s) or Attached Control Enclosure with toggle switch(es) except as noted (please specify).
- ✓ 120 volt models with built in controls require tandem (end-to-end) elements.
- Ⓢ 120 volt models require additional switches and tandem (end-to-end) elements.
- ∞ Models contain tandem (end-to-end) elements that may be individually controlled.

- ▲ Add 2-8 lbs. depending on Remote Control Enclosure (RMB).
- ◎ Includes Remote Control Enclosure (RMB) with toggle switch(es) and indicator light(s) or Attached Control Enclosure with toggle switch(es) except as noted (please specify).
- Ⓢ 120 volt models not available with Built-in Controls.
- ✓ 120 volt models with built in controls require tandem (end-to-end) elements.
- Ⓢ 120 volt models require additional switches and tandem (end-to-end) elements.
- ∞ Models contain tandem (end-to-end) elements that may be individually controlled.
- ◎ All voltages not available with Built-in Controls.

All Glo-Ray Aluminium Max Watt Infrared Models Feature:

Includes: Angle Brackets and Attached or Remote Control Enclosure (RMB).

Leads: 3' conduit with leads – server's right.

Dimensions: 18"-144"W x 6"D x 2 1/2"H.

All Glo-Ray Aluminium Max Watt Infrared Models with Lights Feature:

Includes: Angle Brackets and Attached or Remote Control Enclosure (RMB).

Leads: 3' conduit with leads – server's right.

Dimensions: 18"-144"W x 9"D x 2 1/2"H.

OPTIONS AND ACCESSORIES – PAGE 111

RECOMMENDED MOUNTING HEIGHTS – PAGE 123

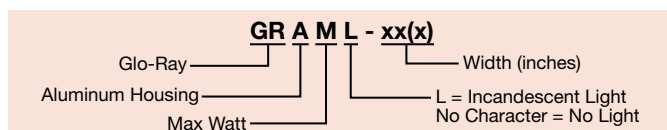



GRAML-48
with standard
angle brackets

OPTIONS (available at time of purchase only)

Designer Colors, aluminum models 18"-144" – Non-standard colors are non-returnable – Clear Anodized Standard –

COLOR-6	6" Housing for GRAM models						per foot	\$52
	RED Warm Red	GRAY Gray Granite	NAVY Navy Blue	COPPER Antique Copper				
	BLACK Black	WHITE White Granite	GREEN Hunter Green					
COLOR-9	9" Housing for GRAML models						per foot	52
	RED Warm Red	GRAY Gray Granite	NAVY Navy Blue	COPPER Antique Copper				
	BLACK Black	WHITE White Granite	GREEN Hunter Green					
RMB-COLOR	Remote Control Enclosure Housing in Designer Colors (select color below)							74
	RED Warm Red	GRAY Gray Granite	NAVY Navy Blue	COPPER Antique Copper				
	BLACK Black	WHITE White Granite	GREEN Hunter Green					

Gloss Finishes, aluminum models 18"-144" – Non-standard colors are non-returnable – Clear Anodized Standard –

GLOSS-6	6" Housing for GRAM models						per foot	\$72
	RRED Radiant Red	GGRAY Glossy Gray	BBLACK Bold Black					
	GGOLD Gleaming Gold	BBLUE Brilliant Blue						
GLOSS-9	9" Housing for GRAML models						per foot	72
	RRED Radiant Red	GGRAY Glossy Gray	BBLACK Bold Black					
	GGOLD Gleaming Gold	BBLUE Brilliant Blue						
RMB-GLOSS	Remote Control Enclosure Housing in Gloss Finishes – Non-standard colors are non-returnable – Clear Anodized Standard –							105
	RRED Radiant Red	GGRAY Glossy Gray	BBLACK Bold Black					
	GGOLD Gleaming Gold	BBLUE Brilliant Blue						

Power Leads – Extended beyond Standard 3' Conduit (must specify lead length) –

HTLEADS5	1'-5' extended Electrical Leads							\$ 61
HTLEADS10	6'-10' extended Electrical Leads							121
HTLEADS15	11'-15' extended Electrical Leads							182
HTLEADS20	16'-20' extended Electrical Leads							242
3 ANEAL REFL	Bright Annealed Reflector for lights with 3" Spacer						per foot	\$ 43

RMB-GRAM-INF Remote Control Enclosure with Toggle Control Switch, Electronic Infinite Control, Relay and Indicator Light (in lieu of Standard Remote Control Enclosure)

BLT TOG	Built in Control - available for GRAML models only							No Charge
NTL-14, -16	Non-Adjustable Tubular Stands – specify 14" or 16" clearance						pair	194
NTL-18, -20	Non-Adjustable Tubular Stands – specify 18" or 20" clearance						pair	205
NTL-22, -24	Non-Adjustable Tubular Stands – specify 22" or 24" clearance						pair	222
NTL-PAINT	Designer Color or Gloss Finish for Non-Adjustable Tubular Stands (one pair) – Non-standard colors are non-returnable –						pair	73

	RED Warm Red	GRAY Gray Granite	NAVY Navy Blue	COPPER Antique Copper				
	BLACK Black	WHITE White Granite	GREEN Hunter Green					
	RRED Radiant Red	GGRAY Glossy Gray	BBLACK Bold Black					
	GGOLD Gleaming Gold	BBLUE Brilliant Blue						

CAP Attached 6' Cord and Plug Set (120V only) on models up to 48" requires built-in controls and standard Chain Mount Kit: Two S Hooks with two 6" lengths of chain (available for GRAM models only)

CHAIN-HOOK	Two S Hooks with two 6" lengths of chain						each	22
HAL	60 Watt Halogen Bulb in lieu of standard Display Light						each	102
NO BULB	No bulb option (GRAML models only)							No Charge

ACCESSORIES (available for purchase at any time)

CHAIN 1	Chain Suspension						per foot	\$ 22
	Chef LED 120V adjustable bulb – GRAML-xx models only, all voltages – pass-through usage only –							
	GRAML-xx must be 13" or higher from surface as pass through – bulbs must be rotated down –							
	CLED-3000-120 Similar to warm Halogen light	CLED-4000-120 Similar to cool Fluorescent light					each	205

COLORS AND FINISHES – PAGE 241

Strip Heaters



Glo-Ray® Aluminum Max Watt Dual Infrared Strip Heaters

Create a deeper holding area with Glo-Ray Aluminium Max Watt Dual Aluminum Infrared Strip Heaters mounted side-by-side, keeping hot food at optimum serving temperatures. The pre-focused heat pattern directs heat from a metal-sheathed element, bathing the entire holding surface. The continuous aluminum housing and heavy-duty mountings ensure the durability and quality of Hatco products.

- Features 25% greater wattage output than Glo-Ray high watt by comparison with dual units varying in wattage from 900 to 8300 watts; and units with lights varying from 1020 to 9020 watts
- Sturdy extruded aluminum housings that do not sag, from 18" to 72" in 6" increments and 84" to 144" in 12" increments
- Protective wire guard supports heating element without affecting heat distribution
- 3" or 6" spacer available
- Heavy-duty insulation minimizes heat loss
- Shatter-resistant incandescent lights (standard on GRAML models) enhance product display while safeguarding food products from bulb breakage. An optional halogen bulb may be used in lieu of incandescents
- Additional reflector styles available, consult factory for more information



GRAM-36D with standard 3" spacer

GLO-RAY ALUMINUM MAX WATT DUAL INFRARED STRIP HEATERS

Model	Width	Voltage Single Phase	Watts	Approx. Ship Weight [▲]	List Price [◎]	
					3" Spacer	6" Spacer
Max Watt						
GRAM-18D	18"	120, 208 or 240	900	13 lbs.	\$1540	\$1562
GRAM-24D	24"	120, 208 or 240	1300	18 lbs.	1598	1620
GRAM-30D	30"	120, 208 or 240	1650	20 lbs.	1723	1755
GRAM-36D	36"	120, 208 or 240	2000	23 lbs.	1847	1879
GRAM-42D	42"	120, 208 or 240	2350	27 lbs.	1974	2006
GRAM-48D	48"	120, 208 or 240	2600	34 lbs.	2105	2146
GRAM-54D	54"	120, 208 or 240	3000	32 lbs.	2247	2288
GRAM-60D	60"	120, 208 or 240	3400	35 lbs.	2397	2460
GRAM-66D [✓]	66"	120, 208 or 240	3750	37 lbs.	2722	2785
GRAM-72D [✓]	72"	120, 208 or 240	4150	43 lbs.	3023	3086
GRAM-84D [✓]	84"	120, 208 or 240	4800	44 lbs.	3401	3486
GRAM-96D [✓] [☼]	96"	120, 208 or 240	5350	54 lbs.	3781	3866
GRAM-108D [☼]	108"	208 or 240	6000	59 lbs.	4441	4526
GRAM-120D [☼]	120"	208 or 240	6800	66 lbs.	4817	4949
GRAM-132D [☼]	132"	208 or 240	7500	73 lbs.	5187	5319
GRAM-144D [☼]	144"	208 or 240	8300	80 lbs.	5559	5691

- ▲ Add 2-8 lbs. depending on Remote Control Enclosure (RMB).
- ◎ Includes Remote Control Enclosure (RMB) with toggle switch(es) and indicator light(s). Built-in controls not available.
- ✓ 120v models require tandem (end-to-end) elements.
- ☼ Units longer than 96" require tandem regardless of voltage.

All Glo-Ray Aluminum Max Watt Dual Infrared Models Feature:

Includes: Angle Brackets and Remote Control Enclosure (RMB).
Leads: 3' conduit with leads – server's right.
Dimensions: with 3" Spacer (standard): 18"-144"W x 15"D x 2½"H.
 with 6" Spacer: 18"-144"W x 18"D x 2½"H.

OPTIONS AND ACCESSORIES – PAGE 114
RECOMMENDED MOUNTING HEIGHTS – PAGE 123

Strip Heaters

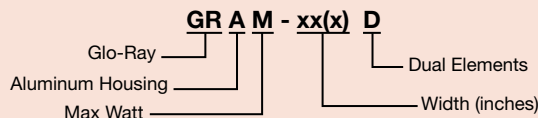

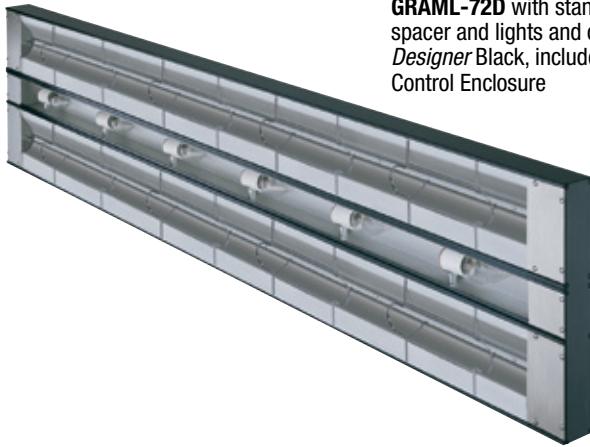

GRAML-72D with standard 3" spacer and lights and optional Black Designer Black, includes Remote Control Enclosure

GLO-RAY ALUMINUM MAX WATT DUAL INFRARED STRIP HEATERS with LIGHTS

Model	Bulbs	Width	Voltage	Watts	Approx. Ship Weight [▲]	List Price [◎]	
			Single Phase			3" Spacer	6" Spacer
Max Watt							
GRAML-18D	2	18"	120, 120/208 or 120/240	1020	15 lbs.	\$1755	\$1777
GRAML-24D	2	24"	120, 120/208 or 120/240	1420	19 lbs.	1804	1826
GRAML-30D	2	30"	120, 120/208 or 120/240	1770	20 lbs.	1971	2003
GRAML-36D	3	36"	120, 120/208 or 120/240	2180	22 lbs.	2116	2148
GRAML-42D	3	42"	120, 120/208 or 120/240	2530	29 lbs.	2282	2314
GRAML-48D	4	48"	120, 120/208 or 120/240	2840	33 lbs.	2439	2480
GRAML-54D	4	54"	120/208 or 120/240	3240	34 lbs.	2623	2664
GRAML-60D	5	60"	120/208 or 120/240	3700	38 lbs.	2806	2869
GRAML-66D ✓	5	66"	120/208 or 120/240	4050	43 lbs.	3163	3226
GRAML-72D ✓	6	72"	120/208 or 120/240	4510	45 lbs.	3494	3557
GRAML-84D ✓	7	84"	120/208 or 120/240	5220	49 lbs.	3921	4006
GRAML-96D ✓	8	96"	120/208 or 120/240	5830	60 lbs.	5085	5170
GRAML-108D	9	108"	120/208 or 120/240	6540	64 lbs.	5015	5100
GRAML-120D	10	120"	120/208 or 120/240	7400	72 lbs.	5468	5600
GRAML-132D	11	132"	120/208 or 120/240	8160	79 lbs.	5928	6060
GRAML-144D	12	144"	120/208 or 120/240	9020	86 lbs.	6390	6522

◎ Includes Remote Control Enclosure (RMB) with toggle switch(es) and indicator light(s). Built-In controls not available.

▲ Add 2-8 lbs. depending on Remote Control Enclosure (RMB).

✓ 120 volt units require tandem (end to end) elements.

✓ GRAML-96D 120v not available with infinite controls.

All Glo-Ray Aluminum Max Watt Dual Infrared Models with Lights Feature:

Includes: Angle Brackets and Remote Control Enclosure (RMB).

Leads: 3' conduit with leads – server's right.

Dimensions: with 3" Spacer (standard): 15"D x 2½"H.

with 6" Spacer: 18"D x 2½"H.

OPTIONS AND ACCESSORIES – PAGE 114

RECOMMENDED MOUNTING HEIGHTS – PAGE 123

Strip Heaters

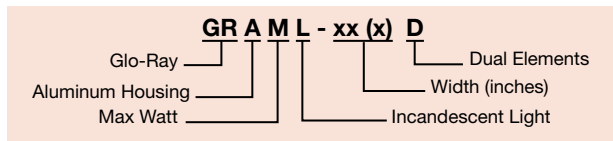



GRAML-60D with optional non-adjustable tubular stands

Strip Heaters

OPTIONS (available at time of purchase only)

Designer Colors, aluminum models 18"-144" – Non-standard colors are non-returnable – Clear Anodized Standard –

COLOR-15, -18	15" and 18" Housings for GRAM and GRAML Dual models					per foot	\$74
	RED Warm Red	GRAY Gray Granite	NAVY Navy Blue	COPPER Antique Copper			
	BLACK Black	WHITE White Granite	GREEN Hunter Green				
RMB-COLOR	Remote Control Enclosure Housing in Designer Colors – Non-standard colors are non-returnable – Clear Anodized Standard –						74
	RED Warm Red	GRAY Gray Granite	NAVY Navy Blue	COPPER Antique Copper			
	BLACK Black	WHITE White Granite	GREEN Hunter Green				

Gloss Finishes, aluminum models 18"-144" – Non-standard colors are non-returnable – Clear Anodized Standard –

GLOSS-15, -18	15" and 18" Housings for GRAM and GRAML Dual models					per foot	\$95
	RRED Radiant Red	GGRAY Glossy Gray	BBLACK Bold Black				
	GGOLD Gleaming Gold	BBLUE Brilliant Blue					
RMB-GLOSS	Remote Control Enclosure Housing in Gloss Finishes						105
	RRED Radiant Red	GGRAY Glossy Gray	BBLACK Bold Black				
	GGOLD Gleaming Gold	BBLUE Brilliant Blue					

Power Leads – Extended beyond Standard 3' Conduit (must specify lead length) –

HTLEADS5	1'-5' extended Electrical Leads						\$ 61
HTLEADS10	6'-10' extended Electrical Leads						121
HTLEADS15	11'-15' extended Electrical Leads						182
HTLEADS20	16'-20' extended Electrical Leads						242
RMB-GRAM-INF	Remote Control Enclosure with Toggle Control Switch, Electronic Infinite Control, Relay and Indicator Light (in lieu of Standard Remote Control Enclosure)						716
3 ANEAL REFL	Bright Annealed Reflector for lights with 3" Spacer					per foot	43
6 ANEAL REFL	Bright Annealed Reflector for lights with 6" Spacer					per foot	63

Stands

NTL-18-D, -20-D	Non-Adjustable Tubular Stands (specify 18" or 20" clearance)					2 pair	412
NTL-22-D, -24-D	Non-Adjustable Tubular Stands (specify 22" or 24" clearance)					2 pair	444
NTL-PAINT-D	Designer Color or Gloss Finish for Non-Adjustable Tubular Stands to match unit color – Non-standard colors are non-returnable –					2 pair	146
HAL	60 Watt Halogen Bulb in lieu of Standard Display Light					each	102
NO BULB	No bulb option (GRAML-xxD models only)						No Charge

ACCESSORIES (available for purchase at any time)

Chef LED 120V adjustable bulb – GRAML-xxD models only, all voltages – pass-through usage only –

GRAML-xxD must be 18" to 24" from surface as pass through – bulbs must be rotated down –

CLED-3000-120	Similar to warm Halogen light	CLED-4000-120	Similar to cool Fluorescent light			each	\$205
----------------------	-------------------------------	----------------------	-----------------------------------	--	--	------	--------------

COLORS AND FINISHES – PAGE 241



Glo-Ray® Narrow Infrared Strip Heaters

Hatco Glo-Ray® Narrow Infrared Strip Heaters keep all hot foods at optimum serving temperatures longer, while the slim design fits ideally in buffet areas. Even the most delicate dishes hold that “just-prepared” look. The entire holding surface is heated evenly with no “cold” spots.

- Slim design that's 2" high and 4" deep
- Available in widths from 18"-72"
- Pre-focused heat pattern maintains serving temperatures longer without continuing to cook the food
- Optional Remote Control Enclosure (RMB) available in *Designer Colors*



GRN-24 in standard *Designer Black* with standard angle brackets

Toggle Switch: Max. 15 Amps
Infinite Switch: Max. 12.2 Amps

GLO-RAY NARROW INFRARED STRIP HEATERS

Model	Width	Voltage (Single Phase)	Watts	Approx. Ship Weight	List Price ^o
Standard Watt					
GRN-18	18"	120, 208 or 240	250	5 lbs.	\$ 652
GRN-24	24"	120, 208 or 240	350	6 lbs.	691
GRN-30	30"	120, 208 or 240	450	9 lbs.	734
GRN-36	36"	120, 208 or 240	575	9 lbs.	780
GRN-42	42"	120, 208 or 240	675	9 lbs.	828
GRN-48	48"	120, 208 or 240	800	11 lbs.	877
GRN-54	54"	120, 208 or 240	925	12 lbs.	928
GRN-60	60"	120, 208 or 240	1050	13 lbs.	994
GRN-66	66"	120, 208 or 240	1160	16 lbs.	1088
GRN-72	72"	120, 208 or 240	1275	17 lbs.	1231
High Watt					
GRNH-18	18"	120, 208 or 240	350	7 lbs.	\$ 663
GRNH-24	24"	120, 208 or 240	500	6 lbs.	702
GRNH-30	30"	120, 208 or 240	660	7 lbs.	745
GRNH-36	36"	120, 208 or 240	800	8 lbs.	791
GRNH-42	42"	120, 208 or 240	950	9 lbs.	839
GRNH-48	48"	120, 208 or 240	1100	11 lbs.	888
GRNH-54	54"	120, 208 or 240	1250	12 lbs.	939
GRNH-60	60"	120, 208 or 240	1400	13 lbs.	1006
GRNH-66 [†]	66"	120, 208 or 240	1560	16 lbs.	1099
GRNH-72 [†]	72"	120, 208 or 240	1725	17 lbs.	1242

- ^o Does not include Remote Control Enclosure (RMB), see pages 125 and 126.
- [†] Infinite Switch not available in 120V. RMB2-1R series Remote Control Enclosure (RMB) required for infinite control.
- [‡] Requires NEMA 5-20P cord (GRNH-66 and GRNH-72).

All Glo-Ray Narrow Infrared Models Feature:

Toggle Switch (max. 15 Amps) With Indicator Light Location: Chef's left side (unless otherwise specified).
Designer Color Angle Brackets: To match unit color and provide 1½" clearance between strip heater and overshelf. Non-standard colors are non-returnable.

Leads: 6" leads – server's right. **Dimensions:** 18"-72"W x 4"D x 2"H.

RECOMMENDED MOUNTING HEIGHTS – PAGE 123
COLORS AND FINISHES – PAGE 241

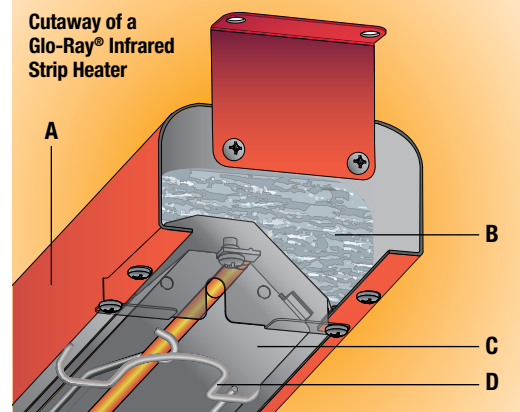

- A** Sturdy housing available in optional Stainless Steel or six optional *Designer Colors* (*Designer Black* standard)
- B** Heavy-duty insulation minimizes heat loss
- C** Aluminized reflector retains full heat intensity and directs more heat towards edges of holding surface
- D** Protective wire guard supports heating element without affecting heat distribution

Strip Heaters

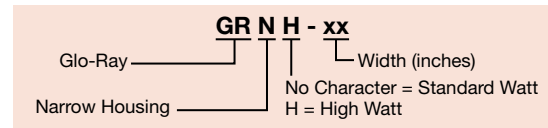

OPTIONS (available at time of purchase only)

Designer Colors, models 18"-72" – Non-standard colors are non-returnable – Black standard –	No Charge
RED Warm Red WHITE White Granite GREEN Hunter Green	
GRAY Gray Granite NAVY Navy Blue COPPER Antique Copper	
Stainless Steel – Additional Charge – Non-standard colors are non-returnable –	per foot \$52
SS Stainless Steel	
Power Leads (must specify lead length) –	
LEADS5 1'-5' extended Electrical Leads	\$ 43
LEADS10 6'-10' extended Electrical Leads	85
LEADS15 11'-15' extended Electrical Leads	128
LEADS20 16'-20' extended Electrical Leads	171
NO CONTROL No control included – Requires selection of RMB2-xx control – see page 125	No Charge
RMB Remote Control Enclosure (available in <i>Designer Colors</i> or <i>Gloss Finishes</i>) – Non-standard colors are non-returnable –	see pages 125 and 126
TABS Stainless steel Hanger Tabs in lieu of Angle Brackets	No Charge
CAP Attached 6' Cord and Plug Set (120V only) on models up to 72" with standard Chain Mount Kit (two S Hooks with two 6" lengths of chain) and hanger tabs (max. 1800 Watt)	\$ 59
CHAIN-HOOK Two S Hooks with two 6" lengths of chain	each 22
NTL-10, -12 Non-Adjustable Tubular Stands (specify 10" or 12" clearance and power location)	1 pair 180
NTL-14, -16 Non-Adjustable Tubular Stands (specify 14" or 16" clearance and power location)	1 pair 194
NTL-PAINT <i>Designer Color</i> for Non-Adjustable Tubular Stands to match unit color – Non-standard colors are non-returnable –	1 pair 73



Glo-Ray® Narrow Max Watt Infrared Strip Heaters

Glo-Ray® Narrow Max Watt Infrared Strip Heaters keep all hot foods at optimum serving temperatures longer, while the slim design fits ideally in buffet areas. The entire holding surface is heated evenly with no "cold" spots.

- Slim design that's 2" high and 4" deep
- Available in widths from 18"-72"
- Pre-focused heat pattern maintains serving temperatures longer without continuing to cook the food
- Available in Stainless Steel only



GRNM-24 in standard Stainless Steel with standard angle brackets

GLO-RAY NARROW MAX WATT INFRARED STRIP HEATERS (must specify and add price of RMB)

Model	Width	Voltage (Single Phase)	Watts	Approx. Ship Weight	List Price ^o
GRNM-18	18"	120, 208 or 240	450	7 lbs.	\$ 744
GRNM-24	24"	120, 208 or 240	650	8 lbs.	804
GRNM-30	30"	120, 208 or 240	825	9 lbs.	868
GRNM-36	36"	120, 208 or 240	1000	10 lbs.	938
GRNM-42	42"	120, 208 or 240	1175	11 lbs.	1011
GRNM-48	48"	120, 208 or 240	1300	13 lbs.	1085
GRNM-54	54"	120, 208 or 240	1500	13 lbs.	1160
GRNM-60	60"	120, 208 or 240	1700	13 lbs.	1242
GRNM-66	66"	120, 208 or 240	1875	16 lbs.	1351
GRNM-72	72"	120, 208 or 240	2075	16 lbs.	1518

^o Does not include Remote Control Enclosure (RMB), see pages 125 and 126.

• Infinite Switch not available in 120V. RMB2-1R series Remote Control Enclosure (RMB) required for infinite control.

All Glo-Ray Narrow Max Watt Infrared Models Feature:

Angle Brackets: Provides 1½" clearance between strip heater and overshef.

Leads: 6" leads – server's right.

Dimensions: 18"-72"W x 4"D x 2"H.

RECOMMENDED MOUNTING HEIGHTS – PAGE 123

OPTIONS (available at time of purchase only)

Power Leads – Extended beyond standard 6" Leads (must specify lead length) –

HTLEADS5	1'-5' extended Electrical Leads	\$ 61
HTLEADS10	6'-10' extended Electrical Leads	121
HTLEADS15	11'-15' extended Electrical Leads	182
HTLEADS20	16'-20' extended Electrical Leads	242
NO CONTROL	No control included – Requires selection of RMB2-xx control – see page 125	No Charge
RMB	Requires Remote Control Enclosure – Not available with Built-In controls	see pages 125 and 126
REM INF	Remote Infinite Switches in lieu of Toggle (max. 12.2 Amps)	each 76
NTL-14, -16	Non-Adjustable Tubular Stands (specify 14" or 16" clearance and power location)	1 pair 194

GR N M - xx

Glo-Ray _____
Narrow Housing _____
Width (inches) _____
M = Max Wattage _____



Glo-Ray® Aluminum Infra-Black® High Watt Strip Heaters

For foodwarming at a close range to food product, the Glo-Ray® Infra-Black® heat technology is ideal, emitting a solid panel of uniform heat. Sturdy continuous single or dual extruded aluminum housings assure quality, durability and a variety of widths, depths, mounting arrangements and colors will fit your operation.

- Provides ideal amount of heat for limited space operations, mounted 4" to 10" above target surface for singles and 8" to 14" for duals
- Metal-sheathed heating element part guaranteed against burnout and breakage for two years
- Infra-Black emitter provides even heat distribution – eliminating hot spots
- Sturdy aluminum housings that do not sag, from 18" to 72" in 6" increments
- Heavy-duty insulation keeps the exterior housing cool
- Optional wire guard available to protect user from incidental contact with heated surface
- Optional 3" or 6" spacer available on dual models with or without lights (see next page)



GRAIH-36 with optional wire guard, requires TCBI or Remote Control Enclosure (RMB)

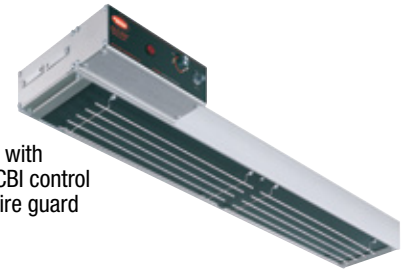

GRAIH-36 with optional TCBI control box and wire guard

Toggle Switch: Max. 15 Amps
Infinite Switch: Max. 12.2 Amps

GLO-RAY ALUMINUM INFRA-BLACK HIGH WATT STRIP HEATERS (must specify and add price of RMB or TCBI)

Model	Width	Voltage Single Phase	Watts	Approx. Ship Weight ^o	List Price ^o
GRAIH-18	18"	120, 208 or 240	350	10 lbs.	\$ 844
GRAIH-24	24"	120, 208 or 240	500	11 lbs.	895
GRAIH-30	30"	120, 208 or 240	660	12 lbs.	952
GRAIH-36	36"	120, 208 or 240	800	13 lbs.	1011
GRAIH-42	42"	120, 208 or 240	950	16 lbs.	1070
GRAIH-48	48"	120, 208 or 240	1100	16 lbs.	1132
GRAIH-54	54"	120, 208 or 240	1250	18 lbs.	1193
GRAIH-60	60"	120, 208 or 240	1400	19 lbs.	1270
GRAIH-66'	66"	120, 208 or 240	1560	23 lbs.	1373
GRAIH-72'	72"	120, 208 or 240	1725	25 lbs.	1561

GLO-RAY ALUMINUM INFRA-BLACK HIGH WATT STRIP HEATERS with LIGHTS (must specify and add price of RMB or TCBI)

Model	No. of Bulbs	Width	Voltage Single Phase	Watts	Approx. Ship Weight ^o	List Price ^o
GRAIHL-18	2	18"	120, 120/208 or 120/240	470	12 lbs.	\$1136
GRAIHL-24	2	24"	120, 120/208 or 120/240	620	14 lbs.	1197
GRAIHL-30	2	30"	120, 120/208 or 120/240	780	16 lbs.	1315
GRAIHL-36	3	36"	120, 120/208 or 120/240	980	18 lbs.	1442
GRAIHL-42	3	42"	120, 120/208 or 120/240	1130	20 lbs.	1573
GRAIHL-48	4	48"	120, 120/208 or 120/240	1340	22 lbs.	1702
GRAIHL-54	4	54"	120, 120/208 or 120/240	1490	24 lbs.	1831
GRAIHL-60	5	60"	120, 120/208 or 120/240	1700	26 lbs.	1996
GRAIHL-66'	5	66"	120, 120/208 or 120/240	1860	28 lbs.	2183
GRAIHL-72' ^o	6	72"	120, 120/208 or 120/240	2085	30 lbs.	2430

- ^o Does not include Remote Control Enclosure (RMB).
- Does not include Remote Control Enclosure (RMB) or Thermostatic Control Box with Indicator Lights (TCBI). Must choose either RMB (see pages 125 and 126) or TCBI (see OPTIONS on page 119).
- ' Infinite Switch not available in 120V.
- ^o 120V models available with remote control only.

All Glo-Ray Aluminum Infra-Black High Watt Models with or without Lights Feature:

Leads: 3' conduit with leads – server's right. 6" leads when supplied with TCBI – exit side of control box.

Dimensions: GRAIH: 18"-72"W x 6"D x 2 3/4"H.

GRAIHL: 18"-72"W x 9"D x 2 3/4"H.

TCBI Control Enclosure dimensions (not including switches): 8"W x 3"D x 2 1/2"H.

Control Enclosure location: Chef's left side – light side (unless otherwise specified).

OPTIONS AND ACCESSORIES – PAGE 119

RECOMMENDED MOUNTING HEIGHTS – PAGE 123

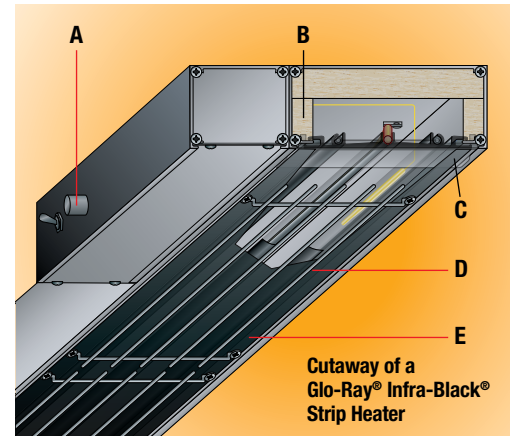

Cutaway of a Glo-Ray® Infra-Black® Strip Heater

- A** Thermostatically controlled to regulate heat and provide consistent temperature. (Optional Remote Control Enclosure (RMB) available)
- B** Heavy-duty insulation minimizes heat loss
- C** Provides ideal amount of heat for limited space operations, effectively holding product
- D** Optional wire guard available to protect user from incidental contact with the heated surface
- E** Infra-Black emitter provides even heat distribution, eliminating hot spots for close applications

Strip Heaters

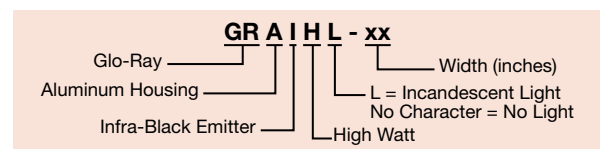



Glo-Ray® Aluminum Infra-Black® High Watt Dual Strip Heaters

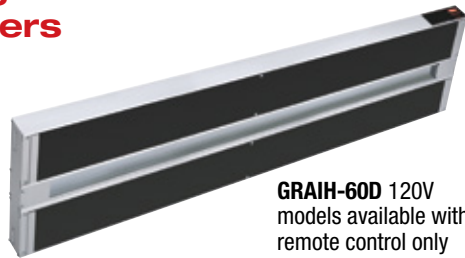

GRAIH-60D 120V models available with remote control only



GRAIHL-24D in optional Radiant Red Gloss Finish

Toggle Switch: Max. 15 Amps
Infinite Switch: Max. 12.2 Amps

GLO-RAY ALUMINUM INFRA-BLACK HIGH WATT DUAL STRIP HEATERS

(must specify and add price of RMB or TCBI)

Model	Width	Voltage		Approx. Ship Weight ^o	List Price ^o	
		Single Phase	Watts		3" Spacer	6" Spacer
GRAIH-18D	18"	120, 208 or 240	700	16 lbs.	\$1944	\$1966
GRAIH-24D	24"	120, 208 or 240	1000	22 lbs.	2058	2080
GRAIH-30D	30"	120, 208 or 240	1320	22 lbs.	2230	2262
GRAIH-36D	36"	120, 208 or 240	1600	27 lbs.	2405	2437
GRAIH-42D ^o	42"	120, 208 or 240	1900	35 lbs.	2588	2620
GRAIH-48D ^o	48"	120, 208 or 240	2200	33 lbs.	2771	2812
GRAIH-54D ^o	54"	120, 208 or 240	2500	41 lbs.	2957	2998
GRAIH-60D ^o	60"	120, 208 or 240	2800	46 lbs.	3200	3263
GRAIH-66D ^o /	66"	120, 208 or 240	3120	44 lbs.	3478	3541
GRAIH-72D ^o /	72"	120, 208 or 240	3450	51 lbs.	3897	3960

GLO-RAY ALUMINUM INFRA-BLACK HIGH WATT DUAL STRIP HEATERS with LIGHTS

(must specify and add price of RMB or TCBI)

Model	No. of Bulbs	Width	Voltage		Approx. Ship Weight ^o	List Price ^o	
			Single Phase	Watts		3" Spacer	6" Spacer
GRAIHL-18D	2	18"	120, 120/208 or 120/240	820	15 lbs.	\$2079	\$2101
GRAIHL-24D	2	24"	120, 120/208 or 120/240	1120	21 lbs.	2196	2218
GRAIHL-30D	2	30"	120, 120/208 or 120/240	1440	25 lbs.	2408	2440
GRAIHL-36D	3	36"	120, 120/208 or 120/240	1780	29 lbs.	2621	2653
GRAIHL-42D ^o	3	42"	120, 120/208 or 120/240	2080	33 lbs.	2833	2865
GRAIHL-48D ^o	4	48"	120, 120/208 or 120/240	2440	35 lbs.	3040	3081
GRAIHL-54D ^o	4	54"	120, 120/208 or 120/240	2740	39 lbs.	3249	3290
GRAIHL-60D ^o	5	60"	120, 120/208 or 120/240	3100	47 lbs.	3554	3617
GRAIHL-66D ^o /	5	66"	120, 120/208 or 120/240	3420	47 lbs.	3884	3947
GRAIHL-72D ^o /	6	72"	120, 120/208 or 120/240	3810	54 lbs.	4613	4676

- ^o Does not include Remote Control Enclosure (RMB).
- ^o Does not include Remote Control Enclosure (RMB) or Thermostatic Control Box with Indicator Lights (TCBI). Must choose either RMB (see pages 125 and 126) or TCBI (see OPTIONS on page 119).
- ^o 120V models available with remote control only.
- / Infinite Switch not available in 120V.
- ^o TCBI not available in 208V, 120/208V.

All Glo-Ray Aluminum Infra-Black High Watt Dual Models with or without Lights Feature:

Leads: 3' conduit with leads – server's right. 6" leads when supplied with TCBI – exit side of control box.

Dimensions: GRAIH-xxD with 3" Spacer: 18"-72"W x 15"D x 2 3/8"H.

GRAIHL-xxD with 3" Spacer: 18"-66"W x 15"D x 2 3/8"H.

GRAIH-xxD with 6" Spacer: 18"-72"W x 18"D x 2 3/8"H.

GRAIHL-xxD with 6" Spacer: 18"-66"W x 18"D x 2 3/8"H.

TCBI Control Enclosure dimensions (not including switches): 8"W x 3"D x 2 1/2"H.

Control Enclosure location: Chef's left side – light side (unless otherwise specified).

OPTIONS AND ACCESSORIES – PAGE 119

RECOMMENDED MOUNTING HEIGHTS – PAGE 123

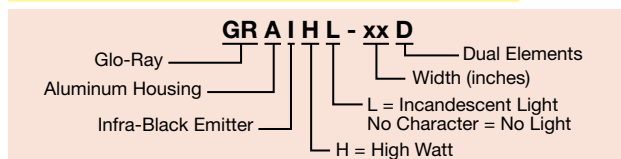

Strip Heaters



GRAIH-72 with optional wire guard, requires Remote Control Enclosure (RMB)

OPTIONS (available at time of purchase only)

Designer Colors – Non-standard colors are non-returnable – Clear Anodized standard –

COLOR-6, -9	6" Housing for GRAIH models and 9" Housing for GRAIHL models						per foot	\$52
	RED Warm Red	GRAY Gray Granite	NAVY Navy Blue	COPPER Antique Copper				
	BLACK Black	WHITE White Granite	GREEN Hunter Green					
COLOR-15, -18	15" and 18" Housings for GRAIH and GRAIHL Dual models						per foot	74
	RED Warm Red	GRAY Gray Granite	NAVY Navy Blue	COPPER Antique Copper				
	BLACK Black	WHITE White Granite	GREEN Hunter Green					

Gloss Finishes – Non-standard colors are non-returnable – Clear Anodized standard –

GLOSS-6, -9	6" Housing for GRAIH models and 9" Housing for GRAIHL models						per foot	\$72
	RRED Radiant Red	GGRAY Glossy Gray	BBLACK Bold Black					
	GGOLD Gleaming Gold	BBLUE Brilliant Blue						
GLOSS-15, -18	15" and 18" Housings for GRAIH and GRAIHL Dual models						per foot	95
	RRED Radiant Red	GGRAY Glossy Gray	BBLACK Bold Black					
	GGOLD Gleaming Gold	BBLUE Brilliant Blue						

AIH18WG -AIH72WG	Element Wire Guard (Dual models require two sets)						per foot (per side)	\$ 54
HAL	60 Watt Halogen Bulb in lieu of standard Display Light						each	102

NO CONTROL	No control included (GRAIH, GRAIHL-xx, GRAIH, GRAIHL-xxD models only) Requires selection of RMB2-xx control – see page 125							No Charge
-------------------	---	--	--	--	--	--	--	-----------

RMB	Remote Control Enclosure – available in <i>Designer Colors</i> or <i>Gloss Finishes</i> – Non-standard colors are non-returnable –							see pages 125 and 126
------------	--	--	--	--	--	--	--	-----------------------

Clear Anodized standard –

	RED Warm Red	GRAY Gray Granite	NAVY Navy Blue	COPPER Antique Copper				
	BLACK Black	WHITE White Granite	GREEN Hunter Green					
	RRED Radiant Red	GGRAY Glossy Gray	BBLACK Bold Black					
	GGOLD Gleaming Gold	BBLUE Brilliant Blue						

TCBI	Thermostatic Control Box with Indicator Lights							\$351
-------------	--	--	--	--	--	--	--	-------

Non-Adjustable Tubular Stands

AIH4NTL	4"						1 pair	180
AIH6NTL	6"						1 pair	180
AIH7.5NTL-D	7.5"						2 pair	361
AIH8NTL	8" (Dual models require two pair)						1 pair	180
AIH10NTL	10" (Dual models require two pair)						1 pair	180
AIH12NTL-D	12"						2 pair	361
AIH14NTL-D	14"						2 pair	387

NTL-PAINT	<i>Designer Color</i> or <i>Gloss Finish</i> for Non-Adjustable Tubular Stands to match unit color – Non-standard colors are non-returnable –						1 pair	73
------------------	--	--	--	--	--	--	--------	----

NTL-PAINT-D	<i>Designer Color</i> or <i>Gloss Finish</i> for Non-Adjustable Tubular Stands to match unit color – Non-standard colors are non-returnable –						2 pair	146
--------------------	--	--	--	--	--	--	--------	-----

Power Leads (must specify lead length) –

HTLEADS5	1'-5' extended Electrical Leads							\$ 61
HTLEADS10	6'-10' extended Electrical Leads							121
HTLEADS15	11'-15' extended Electrical Leads							182
HTLEADS20	16'-20' extended Electrical Leads							242

ACCESSORIES (available for purchase at any time)

ADJ ANGLE	Adjustable Angle Brackets (see page 124 for illustration)						1 pair	\$ 45
ADJ ANGLE7	7" tall Adjustable Angle Brackets (see page 124 for illustration)						1 pair	55
ADJ ANGLE-D	Adjustable Angle Brackets for Dual models (see page 124 for illustration)						2 pair	91
ADJ ANGLE7-D	7" tall Adjustable Angle Brackets for Dual models (see page 124 for illustration)						2 pair	110
CHAIN 1	Chain Suspension (see page 124 for illustration)						per foot	22

Chef LED 120V adjustable bulb – GRAIHL-xx models only, all voltages – pass-through usage only –

	GRAIHL-xx must be 11" or higher from surface as pass through – bulbs must be rotated down –							
	CLED-3000-120 Similar to warm Halogen light	CLED-4000-120 Similar to cool Fluorescent light					each	205

COLORS AND FINISHES – PAGE 241

Strip Heaters



Ultra-Glo® Aluminum Ceramic Infrared Strip Heaters

Hatco Ultra-Glo Aluminum Ceramic Infrared Strip Heaters provide the ultimate holding power. Increased heights improve working clearances and the heat zone blankets the entire holding area. All models include adjustable angle brackets for mounting. Available with or without lights, with Attached or Remote Control Enclosure (recommended).

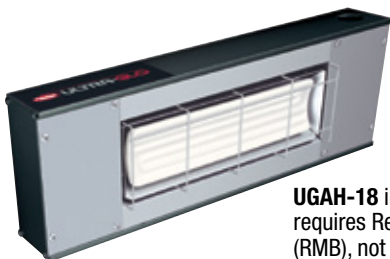

UGAH-18 in optional Gloss Finish, requires Remote Control Enclosure (RMB), not shown

- Pre-focused pyramidal heat pattern concentrates the heat at the edges where heat loss is greatest
- Increased height that the ceramic heat source affords improves operational working clearances, giving the chef and server an improved ergonomic environment in which to work
- Adaptable to many locations and configurations, including back- or front-of-the-house use, open kitchen concepts or buffet lines
- Available in widths from 18" to 72" in 6" increments
- Optional coated shatter-resistant incandescent or halogen bulbs enhance product display while safeguarding food from bulb breakage

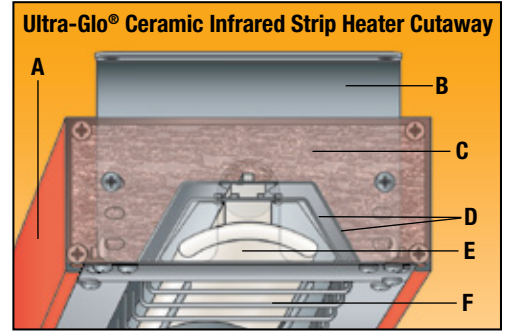

- A** Sturdy aluminum housings that do not sag
- B** Adjustable standard mounting bracket (allows 3 different mounting heights and allows for conduit connection to end of the unit)
- C** Heavy-duty insulation surrounds heating element to keep exterior housing cooler and minimize heat loss
- D** Dual aluminized steel reflector keeps housing cooler, focuses more heat towards the food
- E** Shape of element focuses heat on the food
- F** Protective wire guards under heating element

Strip Heaters

ULTRA-GLO ALUMINUM CERAMIC INFRARED STRIP HEATERS

Model	Width	Voltage Single Phase	Watts	Approx. Ship Weight ^o	List Price ^o
Standard Watt					
UGA-18	18"	120, 208 or 240	500, 490 or 500	9 lbs.	\$1242
UGA-24	24"	120, 208 or 240	650, 675 or 650	10 lbs.	1260
UGA-30	30"	120, 208 or 240	750, 840 or 900	14 lbs.	1517
UGA-36	36"	120, 208 or 240	1000, 980 or 1000	15 lbs.	1533
UGA-42	42"	120, 208 or 240	1000, 1120 or 1200	17 lbs.	1785
UGA-48	48"	120, 208 or 240	1500, 1470 or 1500	19 lbs.	1803
UGA-54	54"	208 or 240	1470 or 1500	20 lbs.	2041
UGA-60	60"	208 or 240	1960 or 2000	22 lbs.	2061
UGA-66	66"	208 or 240	1960 or 2000	25 lbs.	2304
UGA-72	72"	208 or 240	1960 or 2000	25 lbs.	2357

Model	Width	Voltage Single Phase	Watts	Approx. Ship Weight ^o	List Price ^o
High Watt					
UGAH-18	18"	120, 208 or 240	650, 675 or 650	10 lbs.	\$1253
UGAH-24	24"	120, 208 or 240	750, 750 or 750	9 lbs.	1271
UGAH-30	30"	120, 208 or 240	1125, 1125 or 1125	12 lbs.	1528
UGAH-36	36"	120, 208 or 240	1300, 1350 or 1300	15 lbs.	1544
UGAH-42	42"	120, 208 or 240	1500, 1500 or 1500	16 lbs.	1796
UGAH-48	48"	208 or 240	2025 or 1950	19 lbs.	1814
UGAH-54	54"	208 or 240	2250 or 2250	20 lbs.	2052
UGAH-60	60"	208 or 240	2700 or 2600	24 lbs.	2072
UGAH-66	66"	208 or 240	2700 or 2600	23 lbs.	2315
UGAH-72	72"	208 or 240	3000 or 3000	25 lbs.	2368

All Ultra-Glo Aluminum Ceramic Infrared Models Feature:
Models Shipped With: Angle Brackets and Leads (3' conduit whip).
Dimensions With Attached Control Box, Toggle and Indicator Light: 18"-72"W x 9 7/8"D x 2 1/2"H.
Dimensions With Remote Control Enclosure (RMB), Toggle and Indicator Light: 18"-72"W x 6"D x 2 1/2"H.

OPTIONS – PAGE 122

RECOMMENDED MOUNTING HEIGHTS – PAGE 123

REMOTE CONTROL ENCLOSURES (RMB) – PAGE 126

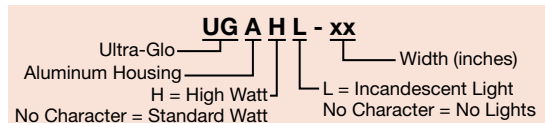

ULTRA-GLO ALUMINUM CERAMIC INFRARED STRIP HEATERS with LIGHTS

Model	No. of Bulbs	Width	Voltage Single Phase	Watts	Approx. Ship Weight ^o	List Price ^o
Standard Watt						
UGAL-18	1	18"	120, 120/208 or 120/240	560, 550 or 560	11 lbs.	\$1522
UGAL-24	2	24"	120, 120/208 or 120/240	770, 795 or 770	10 lbs.	1551
UGAL-30	2	30"	120, 120/208 or 120/240	870, 960 or 1020	15 lbs.	1865
UGAL-36	3	36"	120, 120/208 or 120/240	1180, 1160 or 1180	19 lbs.	1941
UGAL-42	3	42"	120, 120/208 or 120/240	1380, 1300 or 1380	21 lbs.	2240
UGAL-48	4	48"	120, 120/208 or 120/240	1740, 1710 or 1740	22 lbs.	2317
UGAL-54	4	54"	120/208 or 120/240	1710 or 1740	26 lbs.	2620
UGAL-60	5	60"	120/208 or 120/240	2260 or 2300	30 lbs.	2713
UGAL-66	5	66"	120/208 or 120/240	2260 or 2300	31 lbs.	2997
UGAL-72	6	72"	120/208 or 120/240	2320 or 2360	32 lbs.	3092

Model	No. of Bulbs	Width	Voltage Single Phase	Watts	Approx. Ship Weight ^o	List Price ^o
High Watt						
UGAHL-18	1	18"	120, 120/208 or 120/240	710, 735, or 710	12 lbs.	\$1533
UGAHL-24	2	24"	120, 120/208 or 120/240	870, 870 or 870	12 lbs.	1562
UGAHL-30	2	30"	120, 120/208 or 120/240	1245, 1245 or 1245	18 lbs.	1876
UGAHL-36	3	36"	120, 120/208 or 120/240	1480, 1530 or 1480	17 lbs.	1952
UGAHL-42	3	42"	120, 120/208 or 120/240	1680, 1680 or 1680	20 lbs.	2251
UGAHL-48	4	48"	120/208 or 120/240	2265 or 2190	23 lbs.	2328
UGAHL-54	4	54"	120/208 or 120/240	2490 or 2490	25 lbs.	2631
UGAHL-60	5	60"	120/208 or 120/240	3000 or 2900	27 lbs.	2725
UGAHL-66	5	66"	120/208 or 120/240	3000 or 2900	30 lbs.	3008
UGAHL-72	6	72"	120/208 or 120/240	3360 or 3360	32 lbs.	3103

^o Does not include Remote Control Enclosure (RMB).
^o Includes either Attached Control or Remote Control Enclosure (RMB) with toggle switch(es) and indicator light(s).
^o UGAHL-60, -66, -72 in 120/208 and UGAHL-72 in 120/240 require Remote Control Enclosure (RMB) with a Fuse.

All Ultra-Glo Aluminum Ceramic Infrared Models with Lights Feature:

Models Shipped With: Angle Brackets and Leads (3' conduit whip).
Dimensions With Attached Control Box, Toggle and Indicator Light: 18"-72"W x 12 7/8"D x 2 1/2"H.
Dimensions With Remote Control Enclosure (RMB), Toggle and Indicator Light: 18"-72"W x 9"D x 2 1/2"H.

OPTIONS AND REMOTE CONTROL ENCLOSURES (RMB) – PAGE 122
RECOMMENDED MOUNTING HEIGHTS – PAGE 123



Ultra-Glo® Aluminum Ceramic Infrared Dual Strip Heaters

Hatco Ultra-Glo Ceramic Dual Strip Heaters provide the ultimate holding power. Increased height improves working clearances and the heat zone blankets the entire holding area. All models include adjustable angle brackets for mounting. Dual mounted strip heaters accommodate wider food holding areas.

- Increased height that the ceramic heat source affords improves operational working clearances, giving the chef and server an improved ergonomic environment in which to work
- Adaptable to any location and configuration, including back- or front-of-the-house use, open kitchen concepts or buffet lines
- Sturdy extruded aluminum housings eliminate sagging
- Pre-focused heat pattern provides an increased pyramidal dimension, concentrating heat at the edges where heat loss is the greatest

- Available in widths from 18" to 36"
- Remote Control Enclosure with toggle switch, indicator light and wiring for convenient control placement



UGAHL-36D with lights in Standard 3" spacer - Remote Control Enclosure (RMB) required, not shown

ULTRA-GLO ALUMINUM CERAMIC INFRARED DUAL STRIP HEATERS

Model	Width	Voltage		Watts	Approx. Ship Weight ^o	List Price ^o	
		Single Phase				3" Spacer	6" Spacer
Standard Watt							
UGA-18D	18"	120, 208 or 240		1000, 980 or 1000	17 lbs.	\$2467	\$2489
UGA-24D	24"	120, 208 or 240		1300, 1350 or 1300	20 lbs.	2572	2594
UGA-30D	30"	120, 208 or 240		1500, 1680 or 1800	26 lbs.	3120	3152
UGA-36D	36"	208 or 240		1960 or 2000	31 lbs.	3223	3255
High Watt							
UGAH-18D	18"	120, 208 or 240		1300, 1350 or 1300	17 lbs.	\$2489	\$2511
UGAH-24D	24"	120, 208 or 240		1500, 1500 or 1500	20 lbs.	2594	2616
UGAH-30D	30"	208 or 240		2250 or 2250	24 lbs.	3142	3174
UGAH-36D	36"	208 or 240		2700 or 2600	31 lbs.	3245	3277

ULTRA-GLO ALUMINUM CERAMIC INFRARED DUAL STRIP HEATERS with LIGHTS

Model	No. of Bulbs	Width	Voltage		Watts	Approx. Ship Weight ^o	List Price ^o	
			Single Phase				3" Spacer	6" Spacer
Standard Watt								
UGAL-18D	1	18"	120, 120/208 or 120/240		1060, 1040 or 1060	18 lbs.	\$2587	\$2609
UGAL-24D	2	24"	120, 120/208 or 120/240		1420, 1470 or 1420	21 lbs.	2636	2658
UGAL-30D	2	30"	120, 120/208 or 120/240		1620, 1800 or 1920	26 lbs.	3287	3319
UGAL-36D	3	36"	120/208 or 120/240		2140 or 2180	30 lbs.	3430	3462
High Watt								
UGAHL-18D	1	18"	120, 120/208 or 120/240		1360, 1410 or 1360	18 lbs.	\$2609	\$2631
UGAHL-24D	2	24"	120, 120/208 or 120/240		1620, 1620 or 1620	16 lbs.	2658	2680
UGAHL-30D	2	30"	120/208 or 120/240		2370 or 2370	24 lbs.	3309	3341
UGAHL-36D	3	36"	120/208 or 120/240		2880 or 2780	27 lbs.	3452	3484

^o Does not include Remote Control Enclosure (RMB).

^o Includes either Attached Control or Remote Control Enclosure (RMB) with toggle switch(es) and indicator light(s).

All Ultra-Glo Aluminum Ceramic Infrared Dual Models with or without Lights Feature:

Models Shipped With: Angle Brackets and Leads (3' conduit whip).

Dimensions With Attached Control Box, Toggle and Indicator Light: 18" - 36"W x 18⁷/₈" or 21⁷/₈"D x 2¹/₂"H.

Dimensions With Remote Control Enclosure, Toggle and Indicator Light: 18" - 36"W x 15" or 18"D x 2¹/₂"H.

OPTIONS AND REMOTE CONTROL ENCLOSURES (RMB) – PAGE 122

RECOMMENDED MOUNTING HEIGHTS – PAGE 123

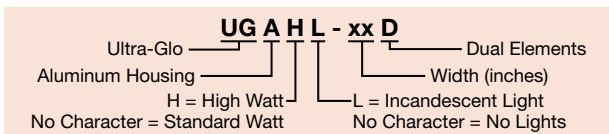



OPTIONS (available at time of purchase only)

Designer Colors, aluminum models 18"-36" – Non-standard colors are non-returnable – Clear Anodized standard –

COLOR-6	6" Housing for Single UGA and UGAH models, 18"- 36" (color selections below)	per foot	\$52				
COLOR-9	9" Housing for Single UGAL and UGAHL models, 18"- 36" (color selections below)	per foot	52				
COLOR-15, -18	15" and 18" Housings for Dual UGA, UGAH, UGAL, UGAHL models, 18"- 36" (color selections below)	per foot	74				
RED	Warm Red	GRAY	Gray Granite	NAVY	Navy Blue	COPPER	Antique Copper
BLACK	Black	WHITE	White Granite	GREEN	Hunter Green		

Gloss Finishes, aluminum models 18"- 36" – Non-standard colors are non-returnable – Clear Anodized standard –

GLOSS-6	6" Housing for Single UGA and UGAH models, 18"- 36" (finish selections below)	per foot	\$72				
GLOSS-9	9" Housing for Single UGAL and UGAHL models, 18"- 36" (finish selections below)	per foot	72				
GLOSS-15, -18	15" and 18" Housings for Dual UGA, UGAH, UGAL, UGAHL models, 18"- 36" (finish selections below)	per foot	95				
RRED	Radiant Red	GGRAY	Glossy Gray	BBLACK	Bold Black		
GGOLD	Gleaming Gold	BBLUE	Brilliant Blue				

Designer Colors for Remote Control Enclosures – Non-standard colors are non-returnable – Clear Anodized standard –

RMB-COLOR	Remote Control Enclosure Housing in Designer Colors	see pages 125 and 126					
RED	Warm Red	GRAY	Gray Granite	NAVY	Navy Blue	COPPER	Antique Copper
BLACK	Black	WHITE	White Granite	GREEN	Hunter Green		

Gloss Finishes for Remote Control Enclosures – Non-standard colors are non-returnable – Clear Anodized standard –

RMB-GLOSS	Remote Control Enclosure Housing in Gloss Finish	see pages 125 and 126					
RRED	Radiant Red	GGRAY	Glossy Gray	BBLACK	Bold Black		
GGOLD	Gleaming Gold	BBLUE	Brilliant Blue				

HAL	60 Watt Halogen Bulb in lieu of standard Display Light	each	\$ 102
LIGHTS ADD'L	Extra Lamps – Installed (max. two per ft. less one, one per ft. is standard) – not available for Dual models	each	52
UGA-NTL-14, -16	Non-Adjustable Tubular Stands – specify 14" or 16" clearance	1 pair	194
UGA-NTL-18, -20	Non-Adjustable Tubular Stands – specify 18" or 20" clearance	1 pair	205
UGA-NTL-22	Non-Adjustable Tubular Stands for 22" clearance	1 pair	222
UGA-NTL-18-D, -20-D	Non-Adjustable Tubular Stands – specify 18" or 20" clearance	2 pair	412
UGA-NTL-22-D, -24-D, -26-D	Non-Adjustable Tubular Stands – specify 22", 24" or 26" clearance	2 pair	444
NTL-PAINT	Designer Colors or Gloss Finishes for Non-Adjustable Tubular Stands to match unit color – Non-standard colors are non-returnable –	1 pair	73
NTL-PAINT-D	Designer Colors or Gloss Finishes for Non-Adjustable Tubular Stands to match unit color – Non-standard colors are non-returnable –	2 pair	146

Power Leads – must specify lead length –

HTLEADS5	1'-5' extended Electrical Leads	\$	61
HTLEADS10	6'-10' extended Electrical Leads		121
HTLEADS15	11'-15' extended Electrical Leads		182
HTLEADS20	16'-20' extended Electrical Leads		242

RMB-UGA-INF	Remote Control Enclosure with Toggle Switch, Electronic Infinite Control, Relay and Indicator Light in lieu of attached control box – Clear anodized Standard –	716
--------------------	---	------------

ACCESSORIES (available for purchase at any time)

Chef LED 120V adjustable bulb – UGA(H)L-xx, UGA(H)L-xxD, models only, pass through usage only –

UGAL models must be at least 14" from surface, UGAHL models must be at least 17" from surface, UGA(H)L-xxD models must be 18"- 22" or higher from surface, all require pass through usage only – bulbs must be rotated down –

CLED-3000-120	Similar to warm Halogen light	CLED-4000-120	Similar to cool Fluorescent light	each	\$205
----------------------	-------------------------------	----------------------	-----------------------------------	-------------	--------------

COLORS AND FINISHES – PAGE 241



CLED-3000 or -4000
Accessory



RMB-UGA-INF

Strip Heater Recommended Range Above Target* and Spacing Requirements (based on 24" strip heaters, non-flammable surface)

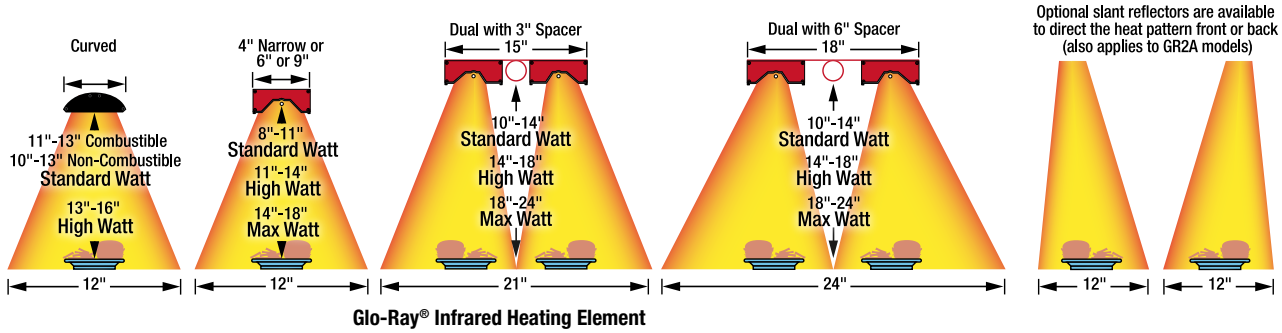

GLO-RAY® INFRARED

Curved Standard Watt (GR5A, GR5AL)

Minimum Combustible: Surface: Install minimum of 1" from back wall, 1" from overshelf and 11" above surface. Minimum non-combustible Surface: 1" from overshelf and 10" above surface (back of wall: no requirement).

Curved High Watt (GR5AH, GR5AHL)

Non-combustible surroundings only. Install 1" from overshelf and minimum of 13" above a non-combustible countertop surface (back of wall: no requirement).

Singles (GRA, GRAL, GRAH, GRAHL, GRN)

Singles Designer (GR2A, GR2AH, GR2AL, GR2AHL)

Combustibles: 13½" high watt or 10" standard watt below, 1" above and 3" to back wall.

Non-combustibles: 1" above, 10" below for high watt with infinite or indicator lamp and 8" below for high watt toggle or standard watt.

Must be installed in a pass-through area. Units with remote switches may be installed against a non-combustible back wall, flush to an overshelf and 8" to a surface below. Maximum 10" setback from the front of an overshelf. Models with cords must be installed 3" below an overshelf and 11" high watt or 10" standard watt over a surface below.

Duals (GRA-D, GRAH-D, GRAL-D, GRAHL-D)

Duals Designer (GR2A-D, GR2AH-D, GR2AL-D, GR2AHL-D)

May not be installed in combustible surroundings.

Non-combustibles: 1" above, 10" below. Must be installed in a pass-through area. Units with remote switches may be installed 3" from a non-combustible back wall, 8" from surface below and flush to an overshelf. Maximum 10" setback from the front of an overshelf.

Singles Max-Watt (GRAM, GRAML, GRNM)

Do not use in combustible surroundings.

Non-combustibles: 1" above, 12" to surface and 3" from back wall. Cord connected: 3" below an overshelf, 12" from surface below. Maximum 10" setback from front of an overshelf.

Duals Max-Watt (GRAM-D, GRAML-D)

May not be installed in combustible surroundings.

Non-combustibles: units may be installed 3" from a non-combustible back wall, 1" below an overshelf, 15" to surface below. Maximum 10" setback from the front of an overshelf.

ULTRA-GLO®

Singles and Duals (UGA, UGA-D, UGAH, UGAH-D, UGAL, UGAL-D, UGAHL, UGAHL-D)

May not be installed in combustible surroundings.

Non-combustibles: 1" above, 17" high watt or 14" standard watt from a surface below and 3" from a back wall.

Dual Mounting Do not mount warmers side by side (dual mounting) with less than a 3" space between units.

GLO-RAY® INFRA-BLACK®

Singles (GRAIH, GRAIHL, GRAIHL-D, GRAIH-D)

May not be installed in combustible surroundings.

Non-combustibles: 1" above and 4" below. Must be installed in a pass-through area. Units with remote switches may be installed 3" from a non-combustible back wall and flush to an overshelf.

Maximum 10" setback from the front of an overshelf.

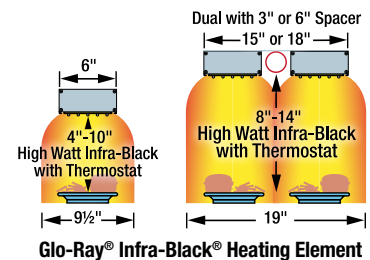
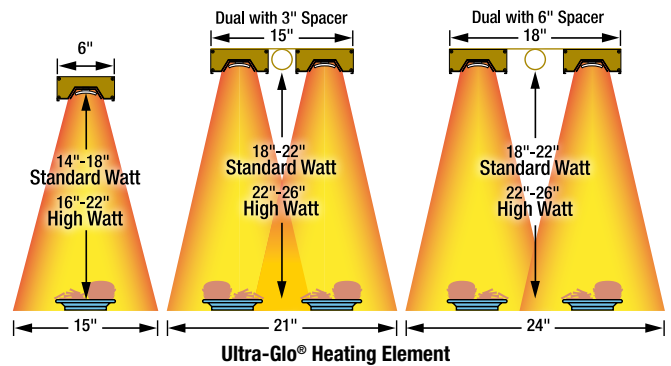
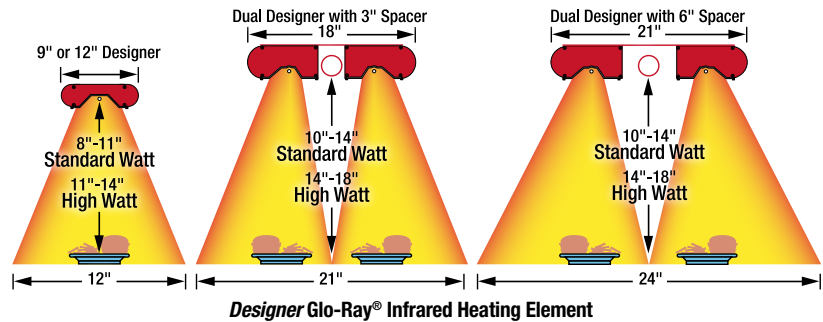

* Recommended single unit application without base heat, based on ideal conditions. Based on a 24" Strip Heater. Individual applications may vary, consult factory. Non-flammable surface only.

Glo-Ray® Mounting Arrangements

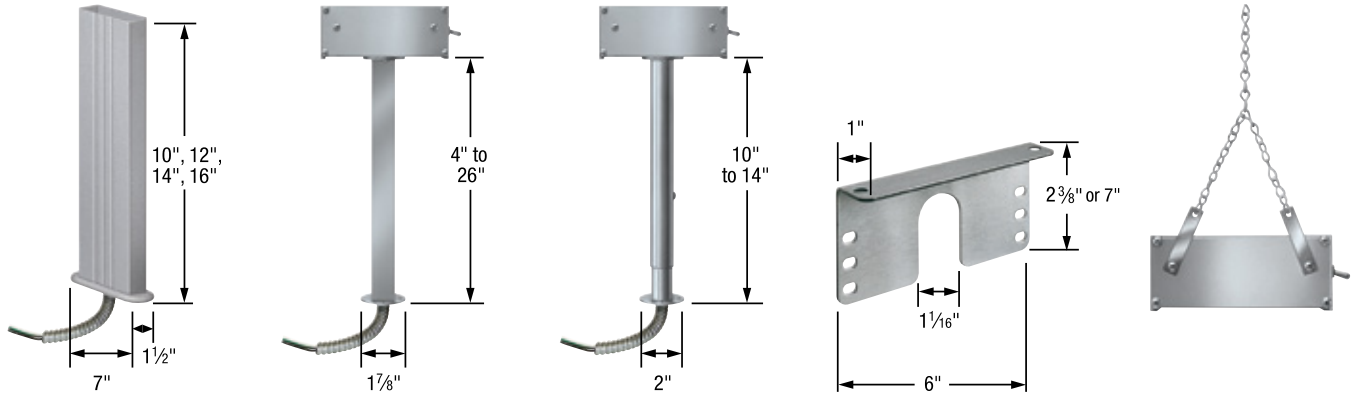

PERMANENT - For hard wired installation

Designer Non-Adjustable Stands

(GR2A series only) Sturdy stands conceal all hook-up wiring. Available in Designer colors.

Non-Adjustable Tubular Stands

Sturdy stands conceal all hook-up wiring. Available in Designer Colors. Duals require two pair. Specify bottom power location.

Adjustable Tubular Stands

Sturdy tubular stands conceal all hook-up wiring. Duals require two pair (not available on Max Watt® or Ultra-Glo® models). Specify bottom power location.

Angle brackets

Special adjustable angle brackets fit 6" or 9" housings for mounting Glo-Ray under a shelf. Provides 1"-2" space or 1"-6" space between Glo-Ray and overshef. Duals require two pair. (standard on Max Watt or Ultra-Glo models).

Chain Suspension

Chains attach to tabs provided with warmers and are available in various lengths to suit the location (not available on Max Watt or Ultra-Glo models).

Strip Heaters

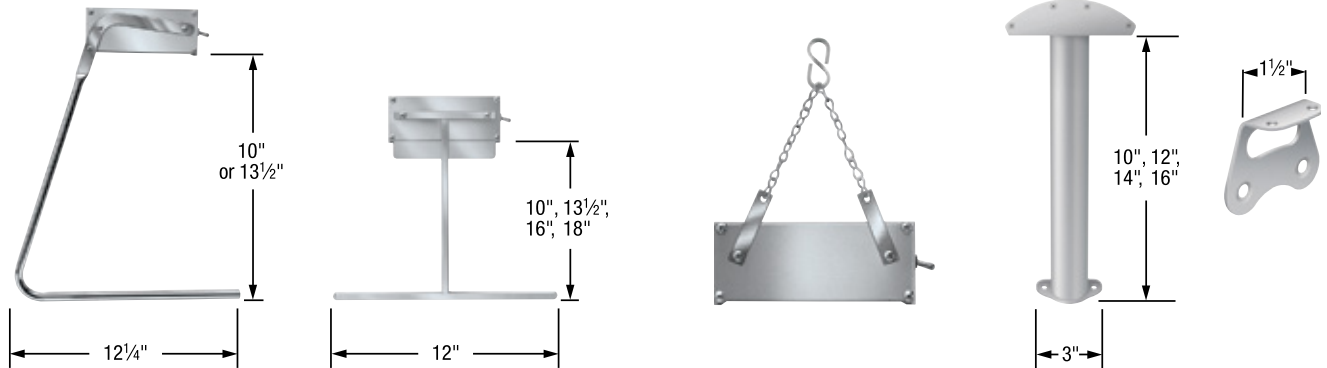

PORTABLE - For cord and plug installation

C-Leg Stands

Attractive chrome plated legs allow easy relocation of the warmer. For models 72" or less in width (not available on Max Watt or Ultra-Glo models). Requires attached cord and plug.

T-Leg Stands

Provide rigid stability and allow for more pass-through area below unit. For models 72" or less in width (not available on Max Watt or Ultra-Glo models). Requires attached cord and plug.

STATIONARY - for cord and plug installation

Chain Hook

Chains attach to tabs provided with warmers. 6" chain with S-Hooks for units with cord and plug only.

GR5A, GR5AH, GR5AL, GR5AHL MOUNTING only

Non-Adjustable Tubular Stands and Angle Brackets

Sturdy stands conceal all hook-up wiring. Specify power location. Standard angle brackets for mounting under a shelf. Provides 1" space between Strip Heater and overshef. End panels and brackets match unit color.



Remote Control Enclosures (RMBs)

1. Find the volt and current (Amp) rating for the Strip Heater(s) the RMB2 will be controlling. This is the total current of all circuits on the warmer(s).
2. If the current rating is under 20 Amps, then select an RMB2-1R, if the current rating is between 20 and 40 Amps, select the RMB2-2R. The RMB2-2R has two 20 Amp outputs.
3. Select the current (Amp) rating of the RMB2 that is just above the total current rating of the warmer(s) it will control. The RMB2 will need to be connected to a branch circuit breaker suitable for its current rating.
4. Select the voltage rating for the RMB2 based on the highest voltage rating of the warmer(s). For example, if the warmer(s) is rated 120/208 volts, select a 208 volt RMB2 control.

- Easy to specify, install and service
- Compatible with most Strip Heaters (GR-XX, GRA-XX(D), GRAH-XX(D), GRAIH-XX(D), GR2A-XX(D), GR2AH-XX(D), GR5A-XX(D), GRN-XX, GRNH-XX and GRAM-XX(D) series)
- Total amperage of light and heat combined cannot exceed max Amp rating of the RMB
- Maximum of 8 Amps total allowed on the light circuit
- Multiple Strip Heaters may be connected to one RMB2 if the combined current draw of the warmers is less than the rating of the RMB2. All warmers will be controlled with same set-point

Need help choosing the correct RMB?
"Choose Remote Box (RMB)" can be found on:
www.hatcocorp.com
under "Resources"



RMB2-2R
with two relays



RMB2-1R
with one relay

Strip Heaters

REMOTE CONTROL ENCLOSURES (RMBs)

Model	Description	Voltage	List Price
RMB2			
RMB2-1R – 1 Toggle, 1 Infinite, 1 Relay, 1 Indicator			
	12 Max. Amps	120, 208, 240	\$1395
	16 Max. Amps	120, 208, 240	
	20 Max. Amps	120, 208, 240	
RMB2-2R – 1 Toggle, 1 Infinite, 2 Relays, 1 Indicator			
	24 Max. Amps	120, 208, 240	\$1591
	32 Max. Amps	120, 208, 240	
	40 Max. Amps	120, 208, 240	

All Models Feature:

Ship Weight: 6-8 lbs. depending on components.

Dimensions: RMB2-1R: 11" W x 4½" D x 5½" H.

RMB2-2R: 14" W x 4½" D x 5½" H.

Cutout Dimensions: RMB2-1R: 10¼" W x 4¾" H.

RMB2-2R: 13⅞" W x 4¾" H.



Remote Control Enclosures (RMBs)

Hatco Remote Control Enclosures (RMBs) are built in accordance with UL standards for toggle or infinite switches, indicator lights and wiring, ready for installation when purchased with Glo-Ray® Strip Heaters. When Remote Control Enclosures are used, no more than one RMB per Strip Heater and no more than one Strip Heater per RMB.

- Built for toggle or infinite switches, indicator lights and wiring
- One RMB per Strip Heater
- Consult RMB configurator for specific details at www.hatcocorp.com, under "Resources"

RMB-7L with toggle switch and infinite control



RMB-16E with infinite controls, toggle switches and optional Designer Warm Red



RMB-14E with infinite controls



RMB-3F with toggle switch and indicator light

RMB-7D with toggle switches and optional Designer Hunter Green



REMOTE CONTROL ENCLOSURES (RMBs)

Model	Description	Voltage	Width	List Price
RMB-3A, -3B, -3C	1 Infinite	120, 208, 240	5½"	\$304
RMB-3D	1 Toggle	120, 208, 240	5½"	271
RMB-3E	2 Toggle	120, 208, 240	5½"	304
RMB-3F, -3G, -3H	1 Toggle, 1 Indicator	120, 208, 240	5½"	304
RMB-7A, -7B, -7C	2 Infinite	120, 208, 240	9"	408
RMB-7D	3 Toggle	120, 208, 240	9"	377
RMB-7E	4 Toggle	120, 208, 240	9"	442
RMB-7F, -7G, -7H	1 Infinite, 1 Indicator	120, 208, 240	9"	365
RMB-7I, -7J, -7K	2 Toggle, 2 Indicator	120, 208, 240	9"	404
RMB-7L, -7M, -7N	1 Toggle, 1 Infinite	120, 208, 240	9"	373
RMB-7O, -7P, -7Q	1 Toggle, 1 Infinite, 1 Indicator	120, 208, 240	9"	408
RMB-7S	2 Toggles, 1 Indicator	120/208, 120/240	9"	373
RMB-14A, -14B, -14C	3 Infinite	120, 208, 240	14"	526
RMB-14D, -14E, -14F	4 Infinite	120, 208, 240	14"	652
RMB-14G	5 Toggle	120, 208, 240	14"	559
RMB-14H	6 Toggle	120, 208, 240	14"	658
RMB-14I, -14J, -14K	3 Toggle, 3 Indicator	120, 208, 240	14"	515
RMB-14L, -14M, -14N	2 Infinite, 2 Indicator	120, 208, 240	14"	533
RMB-14O, -14P, -14Q	2 Toggle, 2 Infinite	120, 208, 240	14"	579
RMB-14R, -14S, -14T	1 Toggle, 1 Infinite w/Relay, 1 Indicator	120, 208, 240	14"	700
RMB-14V, -14W, -14Y	1 Toggle, 2 Infinite	120, 208, 240	14"	506
RMB-14AA, -14AB	Master Toggle, 1 Electronic Infinite w/Relay	120, 208, 240	14"	700
RMB-14AF, -14AG, -14AH	3 Toggle, 2 Indicator	120, 208, 240	14"	479
RMB-14AI, -14AJ, -14AK	1 Toggle, 3 Infinite	120, 208, 240	14"	595
RMB-14AL, -14AM, -14AN	1 Toggle, 2 Infinite, 2 Indicator	120, 208, 240	14"	565
RMB-14AO, -14AP, -14AQ	1 Toggle, 2 Infinite, 3 Indicator	120, 208, 240	14"	599
RMB-14AR, -14AS, -14AT	1 Infinite with Relay, 1 Indicator	120, 208, 240	14"	657
RMB-16B, -16C, -16D	1 Toggle, 4 Infinite	120, 208, 240	16"	701
RMB-16E, -16F, -16G	3 Toggle, 2 Infinite	120, 208, 240	16"	645
RMB-20D, -20E, -20F	3 Toggle, 2 Infinite	120, 208, 240	20"	674
RMB-20G, -20H, -20I	2 Toggle, 4 Infinite	120, 208, 240	20"	802
RMB-20L, -20J, -20K	3 Toggle, 4 Infinite, 4 Indicator	120, 208, 240	20"	950
RMB-20M, -20N, -20P	3 Toggle, 2 Infinite, 2 Indicator	120, 208, 240	20"	740
RMB-20R, -20S, -20T	2 Toggle, 4 Infinite, 4 Indicator	120, 208, 240	20"	919
RMB-20AA, -20AB, -20AC	2 Toggle, 2 Infinite, 2 Indicator	120, 208, 240	20"	701
RMB-20AH, -20AF, -20AG	4 Infinite, 4 Indicator	120, 208, 240	20"	835
RMB-20AN, -20AO, -20AP	4 Toggle, 4 Indicator	120, 208, 240	20"	680

All Models Feature:

Ship Weight: 2-8 lbs. depending on components.

Max. Allowable Amperage per Switch: Toggle 15.0; Infinite 12.2

Dimensions (not including switches): 5½", 9", 14", 16" or 20"W x 3"D x 2½"H.

Toggle Switch: Max. 15 Amps
Infinite Switch: Max. 12.2 Amps

Remote Control Enclosures (RMBs): When used, no more than one RMB per Strip Heater and no more than one Strip Heater per RMB.

Need help choosing the correct RMB?
"Choose Remote Box (RMB)" can be found on:
www.hatcocorp.com
under "Resources"

Strip Heaters

OPTIONS (available at time of purchase only)

Designer Colors – Non-standard colors are non-returnable – Clear Anodized standard –

RMB-COLOR	Remote Control Enclosure Housing in Designer Color						\$74
	RED Warm Red	GRAY Gray Granite	NAVY Navy Blue	COPPER Antique Copper			
	BLACK Black	WHITE White Granite	GREEN Hunter Green				

Gloss Finishes – Non-standard colors are non-returnable – Clear Anodized standard –

RMB-GLOSS	Remote Control Enclosure Housing in Gloss Finish					\$105
	RRED Radiant Red	GGRAY Glossy Gray	BBLACK Bold Black			
	GGOLD Gleaming Gold	BBLUE Brilliant Blue				

COLORS AND FINISHES – PAGE 241

Decorative Lamps & Display Lights





Decorative Lamps & Display Lights



ORDERING INSTRUCTIONS

Luminaire lamps are for lighting only. LUMINAIRE option must be specified when lamps are utilized for decorative purposes only (no heating). This option is not field convertible. Maximum 100 watts.

CLEARANCE REQUIREMENTS

- NOTE:** Install Standard Watt (120V bulb, 250W) no closer than 3" from a sidewall and no closer than 16" above a combustible surface, or no closer than 5" to a non-combustible surface.
- NOTE:** Install HIGH WATT (120V, 375W bulb) no closer than 3" from a sidewall and no closer than 27" above a combustible surface, or no closer than 17" to a non-combustible surface.
- NOTE:** Multiple installation of Decorative Lamps must have a minimum clearance of 12" on center of shade between each unit.



(From left to right) DL-2300-ASN, -2200-SU, -2100-SR, -1800-RL, -2400-SU, -1600-RCL and -1700-ASU

Specify the following information with your order:

1. **Electrical:** Voltage 120V and Wattage 100 (Luminaire), 250 (Standard) or 375 (High)
2. **Mounting Style Code:** AS, AST, RC, RCT, R, RT, S, ST
3. **Switch Location Code:** Lower (L), None (N), Remote (R) or Upper (U). DLH models must have remote switch or none
4. **Shade Style Code:** -400, -500, -600, -700, -725, -750, -760, -775, -800, -1100, -1400, -1500, -1600, -1700, -1800, -2100, -2200, -2300, -2400
5. **Shade and Canopy Colors:**
Warm Red, Black, Gray Granite, White Granite, Navy Blue, Hunter Green, Antique Copper, Smooth White, Gleaming Gold, Glossy Gray, Bold Black, Radiant Red™ (lampshade only), Brilliant Blue* (lampshade only), Clear Coat Brushed Metal™ (lampshade only), Bright Brass™, Bright Nickel™, Bright Copper™, Antique Nickel™, Antique Brass™, Antique Bronze™
6. **Overall Unit Length:** For C, CT, S, ST or AS, AST Mounts, from ceiling to bottom of warmer lamp shade
7. **Clearance:** From bulb to surface (see NOTE Clearance Requirements above)
8. **Accessory Bulb Color/Coating:**
40W Clear Coated (Luminaire only)
250W Clear Uncoated, Clear Coated, Red Uncoated or Red Coated
375W Clear Uncoated, Clear Coated
9. **Optional Cord/Track Color:** Black (standard), White (optional)

™ Special process required and extended lead times, see page 132 for additional charge. Specify your appropriate accessories with your order.
 ▣ Mounting Style availability dependent on Shade Style type. See pages 130 & 131 for details.

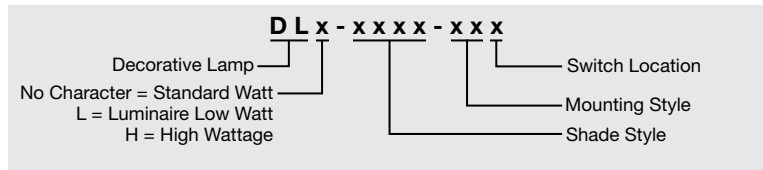
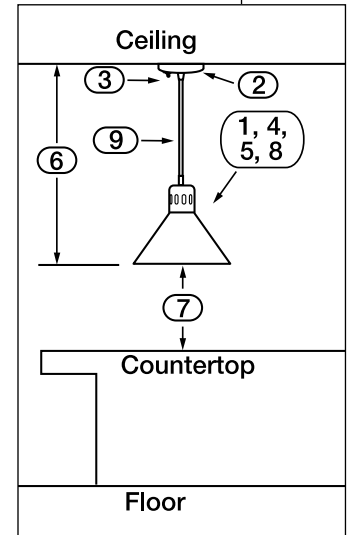



Decorative Lamps/ Luminaires

Hatco Decorative Lamps provide radiant heat to briefly hold food warm at kitchen work areas, wait staff pickup stations or customer serving points, while enhancing your décor. Versatile enough for any location, the range of lights are available with a selection of personalized choices: shade styles, colors, switch locations and mounting arrangements. Configurations for lighting (Luminaire), as well as foodwarming are available.

NOTE: Decorative Lamps and Luminaires are non-returnable.

- Decorative Lamps and Luminaires available in nineteen shade styles
- Ten different mounting arrangements to choose from
- Seven *Designer* colors, seven Gloss finishes and six Plated finishes available
- Four power switch options:
Upper (on canopy)
Lower (at stem)
Remote
None
- Low, standard and high watt bulbs available
- Available for food holding and display or lighting only applications

Rigid and Adjustable Stem Mounts in unit color (except for Gloss finishes Radiant Red, Brilliant Blue and Clear Brushed Metal)

Black or white cord options available. Various cord lengths available, starting at 17", while retractable can vary

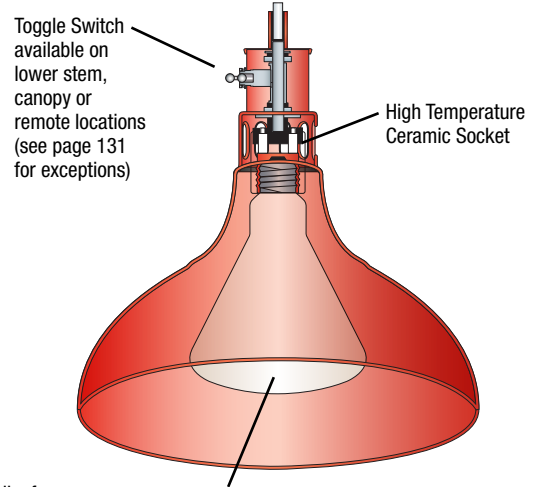

Bulbs for:
40W clear, coated (Luminaire only or DLL models)
250W (DL models) or 375W (DLH models) in clear, coated or uncoated
250W (DL models) red, uncoated or coated

Decorative Lamps & Display Lights

Build A Decorative Lamp

Hatco has given you a variety of simple and easy ways to "Build Your Decorative Lamp." You can go online or quickly do the work tables of "How to Build Your Lamp" on pages 130 through 133.

- GO online at: www.hatcocorp.com and click on "Product Configurators" than "Build a Lamp" in the header. (*Download a PDF of your lamp configuration in color and a Hatco List Price Quote*)
- OR follow the six steps in the Hatco Price List (next four pages) to build your Hatco model code. Then look at the following page for the accessories, like a bulb or track, to easily complete your total order.

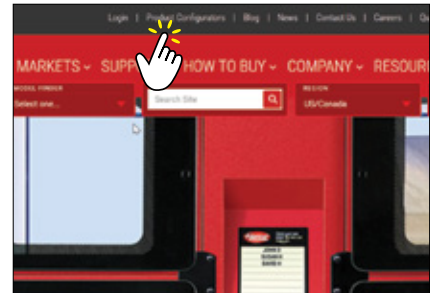

Hatco Website shown, click on "Product Configurators" then "Build A Lamp" in the header to configure your choices



Now you can develop your own Hatco Decorative Lamp solutions with our online lamp configurator.

Visit www.hatcocorp.com
Click on "Build a Lamp"

HOW TO BUILD A LAMP

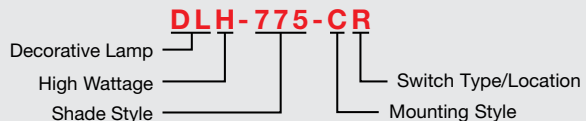

Specify the following options when ordering:

1 Electrical	DLH	(High Watt - 375 watt max)	No Charge
2 Mounting Style	C	(Cord Mount)	No Charge
3 Switch Location	R	(Remote Switch Location)	No Charge
4 Shade Style	-775	(See Shade Style on Page 58)	\$702
5 Shade Color	BBRASS	(Bright Brass Plated Finish)	291
Overall Length	80"	(Overall Length) - Only C mounts	39

(Specify to the nearest inch – CL, CU, CT, ASL, ASU, SL, SU, ST mounts only) **TOTAL \$1032**

Information indicated in red are items that the customer must enter.

Bulbs are not included.



Build A Decorative Lamp Configurator Worksheet

Complete the six steps on this worksheet to configure your Hatco model code and list price. In order to get exactly what you need in the least amount of time, have this handy when ordering your Hatco Decorative Lamp.



BUILD YOUR DECORATIVE/LUMINAIRE LAMPS – STEPS 1 AND 2
 (To determine your total list price and model code, pick all your options - bulb not included)

STEP 1: ELECTRICAL

Voltage	120
Wattage –	No Charge
DLL- Luminaire	100 watt max
DL- Standard	250 watt max
DLH- High Watt	375 watt max

STEP 2: MOUNTING STYLE

Mounting Style –		No Charge
C ®	Cord (specify Cord Color)	
CT* ®	Cord Mount to Track Adapter (specify Cord and Track Color)	\$211
R ®	Coiled Retractable Mount (specify Cord Color)	434
RC ®	Retractable Cord (specify Cord Color)	664
RT* ®	Retractable Mount to Track Adapter (specify Cord and Track Color)	639
RCT* ®	Retractable Cord Mount to Track Adapter (specify Cord and Track Color)	870
S	Stem	119

⊘ Not available with a lower switch for DL-2100, -2200, -2300 or -2400
 ⊘ Not available for DL-2100, -2200, -2300 or -2400

*** NOTE:** Lamp shade diameter and wattage may limit number of lamps per track. To ensure warranty coverage, do not install track systems in damp or wet locations (including above steam tables).



DL-1600-RCL shown with Retractable Cord Mount

DL-1800-RL shown with Coiled Retractable Cord Mount

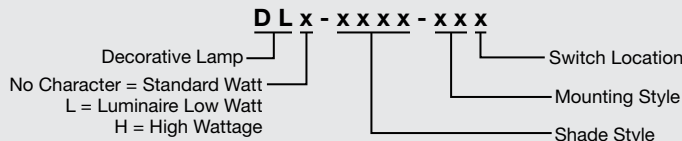

	MOUNTING STYLES	SPECIFY:	Shade Height	
			8½" H	10½" H
CORD	C Mount ® Cord Mount to canopy. 	Overall Length	17" to any length	19" to any length
	CT Mount* ® Cord Mount to track adapter. 			
RETRACTABLE CORD	R Mount ® Coiled Retractable Cord Mount. 	Overall Length Adjusts to a maximum and minimum according to shade height	31" to 69½"	33" to 71½"
	RC Mount ® Retractable Cord Mount. 		24" to 72"	27" to 75"
	RT Mount* ® Coiled Retractable Cord Mount to track adapter. 		33⅜" to 71⅞"	35⅜" to 73⅞"
	RCT Mount* ® Retractable Cord Mount to track adapter. 		27" to 75"	29" to 77"
STEM	S Mount ⊘ Rigid Stem Mount to canopy. 	Overall Length	14" to 71"	16" to 73"

NOTE: Decorative Lamps and Luminaires are non-returnable.

Go to next page to Continue Step 2 (Stem and Adjustable Stem Mounts) and for Step 3.



Build A Decorative Lamp Configurator Worksheet

Continued from page 130



Visit www.hatcocorp.com
Click on "Build a Lamp"

BUILD YOUR DECORATIVE/LUMINAIRE LAMPS – STEPS 2 AND 3 (To determine your total list price and model code, pick all your options - bulb not included)

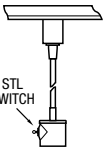
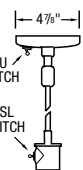
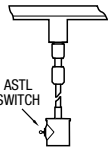
MOUNTING STYLES				
Review Switch Locations below in Step 3 to determine your appropriate model code.		SPECIFY:	Shade Height	
			8½" H	10½" H
STEM	ST Mount* Rigid Stem Mount to track adapter. 	Overall Length	17" to 71"	19" to 73"
			ADJUSTABLE	Adjustable Overall Length (at install only)
14" to 16" 16" to 19½" 20" to 27" 27" to 42" 42" to 72"	16" to 18" 18" to 21½" 22" to 29" 29" to 44" 44" to 74"			
ASL				
16" to 17" 18" to 22" 22" to 28" 29" to 43" 44" to 73"	18" to 19" 20" to 24" 24" to 30" 31" to 45" 46" to 75"			
ADJUSTABLE	AS Mount At install only, limited height adjustments with Rigid Stem Mount to canopy. 	Adjustable Overall Length (at install only)	ASTR, ASTN	
			16" to 18" 18" to 21" 22" to 29" 30" to 44" 45" to 74"	18" to 20" 20" to 23" 24" to 31" 32" to 46" 47" to 76"
			ASTL	
ADJUSTABLE	AST Mount* At install only, limited height adjustments with Rigid Stem Mount to track adapter. 	Adjustable Overall Length (at install only)	18" to 19" 20" to 23" 24" to 31" 31" to 45" 46" to 75"	20" to 21" 22" to 25" 26" to 33" 33" to 47" 48" to 77"

STEP 2: MOUNTING STYLE – continued

Mounting Style –		
ST*	Stem to Track Adapter	\$324
AS	Adjustable Stem Mount (Limited height adjustment at install only, mount with rigid stem mount to canopy)	265
AST*	Adjustable Stem Track Mount (Limited height adjustment at install only, mount with rigid stem mount to track adapter)	455

⊘ Not available with a lower switch for DL-2100, -2200, -2300 or -2400
* **NOTE:** Lamp shade diameter and wattage may limit number of lamps per track. To ensure warranty coverage, do not install track systems in damp or wet locations (including above steam tables).

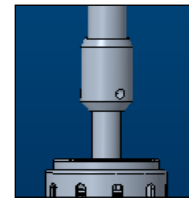

Aluminum Plated Coupler provides a high strength hold for the Adjustable Stem Mount

Decorative Lamps & Display Lights

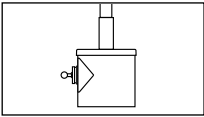
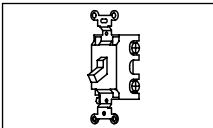
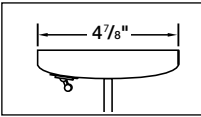
SWITCH LOCATIONS		
 <p>L - Lower Switch Not available on: • DLH (high watt models) • Not available for DL-2100, -2200, -2300 or -2400.</p>	 <p>R - Remote Switch • Accommodates 16 amps • Up to seven 250W lamps, or five 375W lamps maximum per remote switch</p>	 <p>U - Upper Switch Not available on: • DLH (high watt models) • R, RC Mounts • Track mounts (CT, RT, RCT, ST, AST)</p>

STEP 3: SWITCH LOCATION

Switch Location –	No Charge
L	Lower (not available on high watt models)
N	None
R	Remote
U	Upper (not available on high watt models)

Go to next page for Steps 4 and Steps 5.

NOTE: Decorative Lamps and Luminaires are non-returnable.

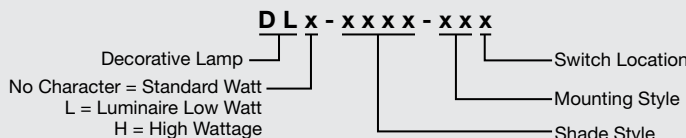



Build A Decorative Lamp Configurator Worksheet

Continued from page 131

BUILD YOUR DECORATIVE/LUMINAIRE LAMPS – STEPS 3 AND 4
(To determine your total list price and model code, pick all your options - bulb not included)



Decorative Lamps & Display Lights

SHADE STYLES (height and width shown)

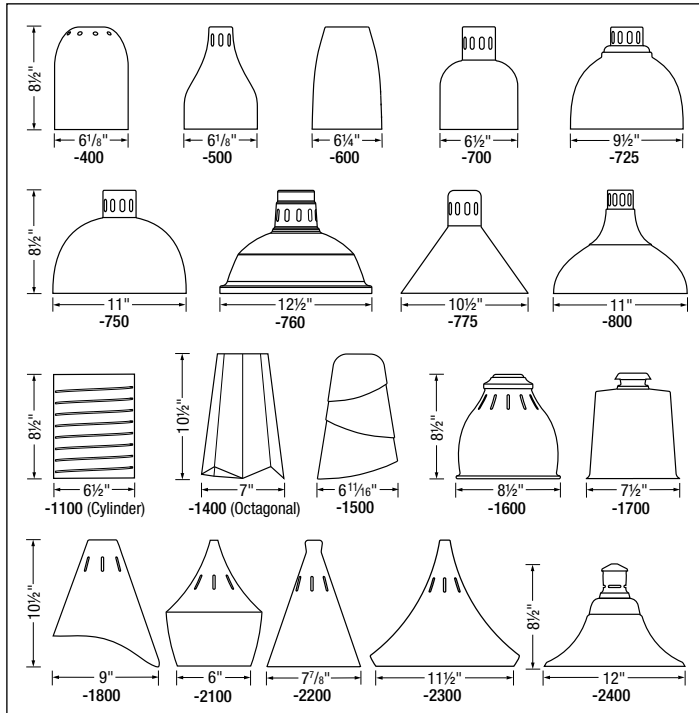

STEP 4: SHADE STYLE

Shade Code	Approx. Ship Weight (depending on components)	List Price
-400	6-10 lbs.	\$641
-500	6-10 lbs.	641
-600	6-10 lbs.	641
-700	6-10 lbs.	641
-725	6-10 lbs.	\$702
-750	6-10 lbs.	702
-760	6-10 lbs.	702
-775	6-10 lbs.	702
-800	6-10 lbs.	702
-1100	6-10 lbs.	702
-1400	6-10 lbs.	702
-1500	6-10 lbs.	\$799
-1600	6-10 lbs.	702
-1700	6-10 lbs.	702
-1800	6-10 lbs.	702
-2100	6-10 lbs.	\$611
-2200	6-10 lbs.	611
-2300	6-10 lbs.	611
-2400	6-10 lbs.	611

SHADE AND CANOPY COLORS

Designer Colors

Warm Red, Black, Gray Granite, White Granite, Navy Blue, Hunter Green, Antique Copper

Gloss Finishes

Smooth White, Gleaming Gold, Glossy Gray, Bold Black

Gloss Finishes for Shade Only – Special Process Required and Extended Lead Times

Radiant Red, Brilliant Blue, Clear Brushed Metal

Printed colors are a representation and may not exactly match our Designer, Gloss and Plated Finishes.

STEP 5: SHADE AND CANOPY COLORS[®]

Designer Colors		No Charge
RED	Warm Red	NAVY Navy Blue
BLACK	Black	GREEN Hunter Green
GRAY	Gray Granite	COPPER Antique Copper
WHITE	White Granite	
Gloss Finishes		No Charge
SWHITE	Smooth White	GGRAY Glossy Gray
GGOLD	Gleaming Gold	BBLACK Bold Black
[®] Gloss Finishes for Shade Only – (must choose other finish for remainder of unit) – Special Process Required and Extended Lead Times –		
RRED	Radiant Red	
BBLUE	Brilliant Blue	
CL-COAT	Clear Brushed Metal	

Go to next page to Continue Step 5 (Plated Finishes) and for Step 6.

NOTE: Decorative Lamps and Luminaires are non-returnable.

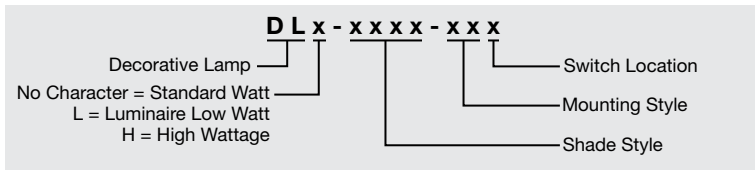



Build A Decorative Lamp Configurator Worksheet

Continued from page 132



Visit www.hatcocorp.com
Click on "Build a Lamp"

BUILD YOUR DECORATIVE/LUMINAIRE LAMPS – STEPS 5 AND 6
(To determine your total list price and model code, pick all your options - bulb not included)

STEP 5: SHADE AND CANOPY COLORS

Plated Finishes –
Special Process Required and Extended Lead Times –

B BRASS	Bright Brass	\$291
B NICKEL	Bright Nickel	291
B COPPER	Bright Copper	291
A NICKEL	Antique Nickel	291
A BRASS	Antique Brass	291
A BRONZE	Antique Bronze	291

Plated Finishes – Special Process Required and Extended Lead Times



* Exception: DL-1500 for Shade Only –



* Gloss and Plated Finishes – Special Process Required and Extended Lead Times

Printed colors are a representation and may not exactly match our Designer, Gloss and Plated Finishes.

STEP 6: OVERALL LENGTH

Overall Length – For C or CT Mounts, from ceiling to bottom of lamp shade.

Up to 72"	No Charge
Greater than 72" (C or CT Mount only)	\$39

Decorative Lamps & Display Lights

YOUR TOTAL LIST PRICE AND MODEL CODE

Add the total costs of options below (not for retrofit – bulb not included) –

Step 1	Electrical	\$ 0.00
Step 2	Mounting Style	
Step 3	Switch Location	0.00
Step 4	Shade Style	
Step 5	Shade and Canopy Colors	
Step 6	Overall Length	
Your Total Price		\$

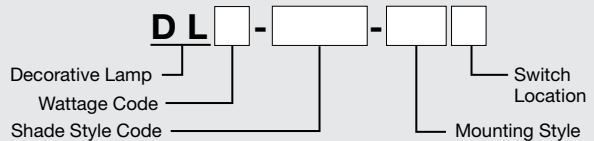

NOTE: Decorative Lamps and Luminaires are non-returnable.

BULBS AND ACCESSORIES – PAGE 134

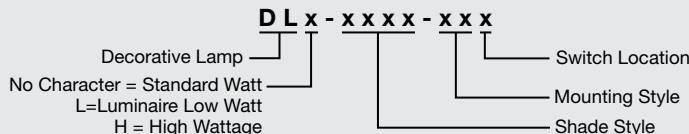



TRACK INSTALLATION AND MODIFICATION KIT –
Highlighted components (for cutting Track Length into multiple sections)

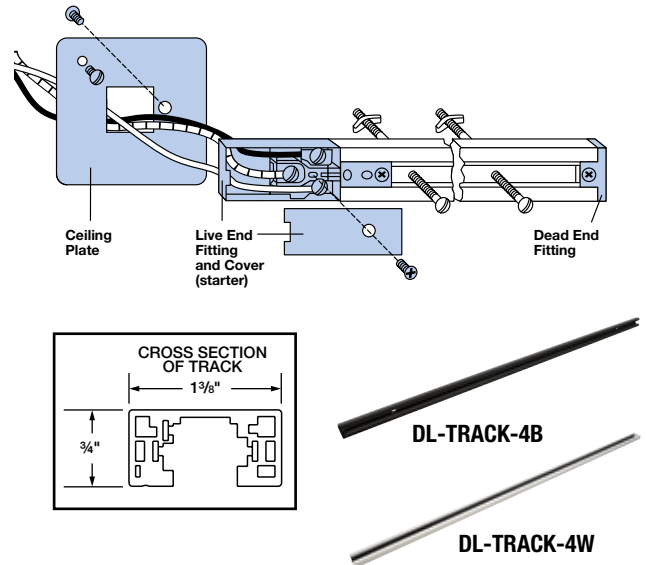

NOTE: Decorative Lamps and Luminaires are non-returnable.

OPTIONS (available at time of purchase only)

DL-CORD-BK	Black Cord – Standard (C=Cord, R=Retractable Mounts Only)	No Charge
DL-CORD-WHITE	White Cord (C=Cord, R=Retractable Mounts Only)	No Charge
Leads – For any Stem Mount or Adjustable Stem Mount unit, must specify Lead Length –		
LEADS5	1'-5' Extended Electrical Leads	\$ 43
LEADS10	6'-10' Extended Electrical Leads	85
LEADS15	11'-15' Extended Electrical Leads	128
LEADS20	16'-20' Extended Electrical Leads	171

ACCESSORIES (available for purchase at any time)

DL-TRACK-4B	4' Track Mount Bar, Black [△] =	\$ 446
DL-TRACK-4W	4' Track Mount Bar, White [△] =	446
DL-TRACK-8B	Two 4' Track Mount Bars with Couplers, Black ^{△=∅}	672
DL-TRACK-8W	Two 4' Track Mount Bars with Couplers, White ^{△=∅}	672
DL-TRACK-12B	Three 4' Track Mount Bars with Couplers, Black ^{△=∅}	953
DL-TRACK-12W	Three 4' Track Mount Bars with Couplers, White ^{△=∅}	953
DL-TRACK-16B	Four 4' Track Mount Bars with Couplers, Black ^{△=∅}	1178
DL-TRACK-16W	Four 4' Track Mount Bars with Couplers, White ^{△=∅}	1178
DL-TRACKBLK	Additional Track Installation and Modification Kit (includes Ceiling Plate, Live End Fitting and Cover (Starter) and Dead End Fitting) – Black (for cutting Track Length into multiple sections, see above)	179
DL-TRACKWHT	Additional Track Installation and Modification Kit (includes Ceiling Plate, Live End Fitting and Cover (Starter) and Dead End Fitting) – White (For cutting Track Length into multiple sections, see above)	179
DL-SWITCH-16AMP	16 Amp Lamp Toggle Switch	each 34
WHITE-CTD-120L	120 Volt, 40 Watt Clear Bulb, Coated (Luminaire models only)	each 25
WHITE-UCTD-120	120 Volt, 250 Watt Clear Bulb, Uncoated	each 41
WHITE-UCTD-120H	120 Volt, 375 Watt Clear Bulb, Uncoated (high watt models only)	each 74
WHITE-CTD-120	120 Volt, 250 Watt Clear Bulb, Coated	each 59
WHITE-CTD-120H	120 Volt, 375 Watt Clear Bulb, Coated (high watt models only)	each 96
RED-UCTD-120	120 Volt, 250 Watt Red Bulb, Uncoated	each 58
RED-CTD-120	120 Volt, 250 Watt Red Bulb, Coated	each 74

⁼ Tracks may be cut to fit any length by installer. Modification kits available.

[△] Maximum seven (7) 250 watt lamps or five (5) 375 watt lamps per 20 amp Track Bar Circuit. Maximum 1920 watts or 16 amps per any length track. Installer is responsible for properly sizing the supply circuit and the lamp load. Lamp shade diameter and wattage may limit number of lamps per track.

Overall length may not add up to the exact desired size for 8', 12' or 16' due to cumulative deductions for each 4' section used.

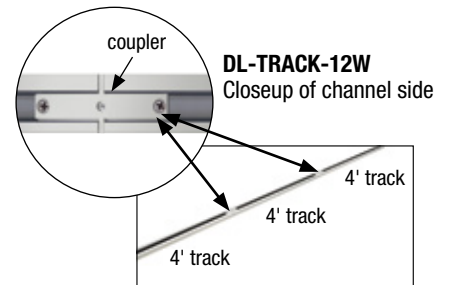

RED uncoated, **WHITE** uncoated,
RED coated, **WHITE** coated





Glo-Rite® Curved Display Lights

A stylish choice for illuminating your serving area. The Glo-Rite® Curved Display Light offers the highest light output that is ideal for illuminating food products with either a warm white light (3050K) or a cool or neutral white light (4100K).

Hatco provides you with a wide variety of colors and lengths for any serving area.

- Features a patented curved housing design with energy efficient dual LED lights across the display lamp that provide longer performance and energy savings (compared to standard incandescent bulbs)

- Field replaceable dual LED lights
- Matches the Hatco line of Glo-Ray® Curved Infrared Strip Heaters for a fully integrated look
- Angle brackets and 6" LED leads are standard
- Optional non-adjustable tubular stands and top or bottom mounting stands available

HL5-36
Clear Anodized (standard) shown in top and underside views

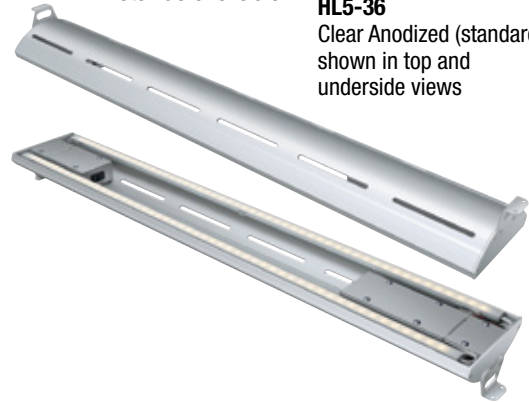

Decorative Lamps & Display Lights

GLO-RITE® CURVED DISPLAY LIGHTS

Model	Width	Voltage		Approx. Ship Weight	List Price
		Single Phase	Watts		
HL5-18	18"	120	4.3	9 lbs.	\$1726
HL5-24	24"	120	5.9	12 lbs.	1883
HL5-30	30"	120	7.6	12 lbs.	2040
HL5-36	36"	120	9.2	12 lbs.	2197
HL5-42	42"	120	10.8	14 lbs.	2354
HL5-48	48"	120	12.4	16 lbs.	2511
HL5-54	54"	120	14.0	17 lbs.	2668
HL5-60	60"	120	15.7	18 lbs.	2825
HL5-66	66"	120	17.3	19 lbs.	2982
HL5-72	72"	120	18.9	20 lbs.	3139

All Curved Display Light Models Feature:

Voltage: 120, single phase.

Models Shipped with: End panels, angle brackets with rocker switch underunit on power side.

Leads: 6" leads - on power side.

Dimensions: 18"-72"W x 6"D x 3"H (height includes standard angle bracket).

OPTIONS (available at time of purchase only)

Non-Adjustable Anodized Stands – Clear Anodized Standard Side Mount Leg –

SNTL5-10T,-12T	Top mounting stand (specify 10" or 12" clearance)	\$357
SNTL5-14T,-16T	Top mounting stand (specify 14" or 16" clearance)	405
SNTL5-10B,-12B	Bottom mounting stand (specify 10" or 12" clearance)	357
SNTL5-14B,-16B	Bottom mounting stand (specify 14" or 16" clearance)	405

Bottom Mount Leg –

NTL5-10,-12	Tubular stands (specify 10" or 12" clearance)	1 pair \$264
NTL5-14,-16	Tubular stands (specify 14" or 16" clearance)	1 pair 332

NTL5-PAINT	Designer color or Gloss Finish for Non-Adjustable Tubular Stands – Non-standard colors are non-returnable –	1 pair 74
-------------------	---	------------------

Designer Colors – Non-standard colors are non-returnable Clear Anodized Standard –

RED	Warm Red	GRAY	Gray Granite	NAVY	Navy Blue	COPPER	Antique Copper	per foot \$52
BLACK	Black	WHITE	White Granite	GREEN	Hunter Green			

Gloss Finishes – Non-standard colors are non-returnable

GGOLD	Gleaming Gold	BBLACK	Bold Black	BBLUE	Brilliant Blue	GGRAY	Glossy Gray	per foot \$72
RRED	Radiant Red							

LED Leads (must specify LED Lead Length) –

HL5-LEAD5	5' total LED Lead Length (includes a 3' conduit)	\$ 59
HL5-LEAD6	6' total LED Lead Length (includes a 3' conduit)	76
HL5-LEAD7	7' total LED Lead Length (includes a 3' conduit)	92
HL5-LEAD8	8' total LED Lead Length (includes a 3' conduit)	109

HL5-LEAD9	9' total LED Lead Length (includes a 3' conduit)	\$125
HL5-LEAD10	10' total LED Lead Length (includes a 3' conduit)	142
HL5-CORD	6' Cord with Plug (NEMA 5-15P)	59

LED Light –

HL5-3050	Warm White (3050K)	Standard
HL5-4100	Cool or Neutral White (4100K)	No Charge

HL5-36 with SG5-36-CA
Sneeze Guard Accessory



Curved tempered glass Sneeze Guard with penciled and polished edges for HL5 models – 24" D x 4 1/8" H

With Black Anodized Hardware –

SG5-18-BA	Sneeze Guard fits 18" HL5-18 model	\$ 846
SG5-24-BA	Sneeze Guard fits 24" HL5-24 model	862
SG5-30-BA	Sneeze Guard fits 30" HL5-30 model	887
SG5-36-BA	Sneeze Guard fits 36" HL5-36 model	920
SG5-42-BA	Sneeze Guard fits 42" HL5-42 model	1018
SG5-48-BA	Sneeze Guard fits 48" HL5-48 model	1058
SG5-54-BA	Sneeze Guard fits 54" HL5-54 model	1083
SG5-60-BA	Sneeze Guard fits 60" HL5-60 model	1156
SG5-66-BA	Sneeze Guard fits 66" HL5-66 model	1180
SG5-72-BA	Sneeze Guard fits 72" HL5-72 model	1204

With Clear Anodized Hardware –

SG5-18-CA	Sneeze Guard fits 18" HL5-18 model	\$ 846
SG5-24-CA	Sneeze Guard fits 24" HL5-24 model	862
SG5-30-CA	Sneeze Guard fits 30" HL5-30 model	887
SG5-36-CA	Sneeze Guard fits 36" HL5-36 model	920
SG5-42-CA	Sneeze Guard fits 42" HL5-42 model	1018
SG5-48-CA	Sneeze Guard fits 48" HL5-48 model	1058
SG5-54-CA	Sneeze Guard fits 54" HL5-54 model	1083
SG5-60-CA	Sneeze Guard fits 60" HL5-60 model	1156
SG5-66-CA	Sneeze Guard fits 66" HL5-66 model	1180
SG5-72-CA	Sneeze Guard fits 72" HL5-72 model	1204

HL5 - x x

Glo-Rite Curved Display Light Width (Inches)
Aluminum Housing

⊙ Side mount legs are not available for corded units.

COLORS AND FINISHES – PAGE 241



Glo-Rite® Display Lights

Let the light shine on your work surface or display areas with the Glo-Rite® Display Lights. Durable and effective, Hatco light strips are made of extruded aluminum housings with bright-annealed reflectors for maximum brightness.

- Incandescent bulbs with special protective coating to guard against food contamination
- Extra lamps available on models from 24" to 72"
- Optional *Designer* colors: Warm Red, Black, Gray Granite, White Granite, Navy Blue, Hunter Green, Antique Copper



HL-24-2 including extra lamp assembly with lamps on 12" centers standard

Quick-Ship Program Information Inside Back Cover

Decorative Lamps & Display Lights

GLO-RITE DISPLAY LIGHTS

Model	Voltage Single Phase	No. of Bulbs	Width	Watts [▲]	Approx. Ship Weight	List Price
HL-18	120	2	18"	120	6 lbs.	\$ 618
HL-24	120	2	24"	120	7 lbs.	654
HL-24-2	120	3	24"	180	6 lbs.	741
HL-30	120	2	30"	120	7 lbs.	691
HL-30-2	120	4	30"	240	8 lbs.	821
HL-36	120	3	36"	180	8 lbs.	789
HL-36-2	120	5	36"	300	9 lbs.	933
HL-42	120	3	42"	180	10 lbs.	824
HL-42-2	120	6	42"	360	10 lbs.	1011
✓ HL-48	120	4	48"	240	11 lbs.	921
HL-48-2	120	7	48"	420	12 lbs.	1123
HL-54	120	4	54"	240	12 lbs.	957
HL-54-2	120	8	54"	480	13 lbs.	1201
✓ HL-60	120	5	60"	300	13 lbs.	1055
HL-60-2	120	9	60"	540	13 lbs.	1313
HL-66	120	5	66"	300	14 lbs.	1180
HL-66-2	120	10	66"	600	15 lbs.	1468
HL-72	120	6	72"	360	18 lbs.	1304
HL-72-2	120	10	72"	600	22 lbs.	1610

▲ Rated at 60 watt but comes with 40 watt incandescent bulb.

All Display Light Models Feature:

Toggle Switch (max. 15 amps) Location: Chef's left side (unless otherwise specified).

Leads: 6" leads – server's right.

Dimensions: 3"D x 2½"H.

OPTIONS (available at time of purchase only)

HAL	60 watt Halogen Bulb in lieu of standard Display Light	each \$102
NO BULB	No Bulb	No Charge
REM TOG	Remote Toggle Switch (max. 15 Amps)	No Charge

Leads (must specify Lead Length) –

LEADS5	1'-5' Extended Electrical Leads	\$ 43
LEADS10	6'-10' Extended Electrical Leads	85
LEADS15	11'-15' Extended Electrical Leads	128
LEADS20	16'-20' Extended Electrical Leads	171

ACCESSORIES (available for purchase at any time)

HL-BRKT	Adjustable Angle Bracket	pair \$ 48
<i>Chef Bulbs (120V) adjustable bulb – Bulbs must be rotated down –</i>		
CLED-3000-120	Chef LED Bulb (similar to warm Halogen light)	each 205
CLED-4000-120	Chef LED Bulb (similar to cool Fluorescent light)	each 205

COLORS AND FINISHES – PAGE 241

OPTIONS (available at time of purchase only)

Designer Colors - Non-standard colors are non-returnable –

RED	Warm Red	per foot \$52
BLACK	Black	per foot 52
GRAY	Gray Granite	per foot 52
WHITE	White Granite	per foot 52
NAVY	Navy Blue	per foot 52
GREEN	Hunter Green	per foot 52
COPPER	Antique Copper	per foot 52

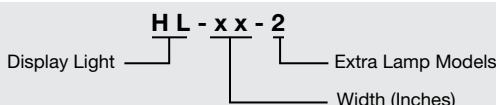

Fry Stations





Glo-Ray® Fry Stations

Hatco offers convenient Glo-Ray® Fry Stations that can be placed where they are most needed – next to a fryer! Glo-Ray heat technology offers the ability to keep fried foods at optimum temperatures, ready to serve, without cooking or drying them out.

- Accessory hardcoated fry ribbons stage boxed or bagged products for quick-service areas
- Thermostatically-controlled heated base maintains uniform holding temperatures from below (GRFHS series)
- Portable models including pass-through style (GRFHS series)
- Sectional divider permits holding of multiple products simultaneously (GRFHS series)
- Ceramic elements and slotted holding bin prevent soggy product (GRFHS series)
- Accessory hardcoated fry ribbons absorb more radiant heat than stainless steel, can be up to 15° to 20°F hotter (GRFHS series)
- Fry Station Warmers (GRFSC, GRFS series) feature a built-in top heat source and a swing-away post mount
- GRFSC series available with ceramic heating element, while the GRFS series has a metal sheathed element
- Variety of clearances (GRFS series)
- GRFS series has power toggle switch, cord and plug, plus optional infinite control

GRFHS-21 with optional right-hand cutout for fry basket and accessory fry ribbon (left-hand cutout also available)



GRFHS-PTT21



GRFHS-16



GRFSC-18
Swing-away
post mount

Quick-Ship Program Information *Inside Back Cover*

PORTABLE FRY HOLDING STATIONS

Model	No. of Bulbs	Dimensions (W x D x H)	Voltage (Single Phase)	Watts	Plug	Approx. Ship Weight	List Price
✓ GRFHS-16**	2	18 ³ / ₂₅ " x 22 ¹⁹ / ₂₀ " x 22 ⁴⁹ / ₆₄ "	120	1090	NEMA 5-15P	51 lbs.	\$5373
✓ GRFHS-21**	2	23 ³ / ₂₅ " x 28 ¹³ / ₃₂ " x 22 ⁴⁹ / ₆₄ "	120	1200	NEMA 5-15P	63 lbs.	5927
GRFHS-22	2	21 ²⁹ / ₆₄ " x 18 ¹³ / ₃₂ " x 17 ⁹ / ₃₂ "	120	1030	NEMA 5-15P	44 lbs.	5099
✓ GRFHS-26**	2	26 ²⁵ / ₆₄ " x 23 ¹³ / ₃₂ " x 22 ¹ / ₈ "	120	1200	NEMA 5-15P	66 lbs.	6069
GRFHS-PT16*	2	21 ¹⁹ / ₃₂ " x 23 ¹³ / ₆₄ " x 24 ³⁹ / ₆₄ "	120	1090	NEMA 5-15P	60 lbs.	5373
GRFHS-PT26*	2	29 ¹³ / ₃₂ " x 22 ²³ / ₃₂ " x 24 ³⁹ / ₆₄ "	120	1440	NEMA 5-15P	64 lbs.	6069
GRFHS-PT26**	2	29 ¹³ / ₃₂ " x 22 ²³ / ₃₂ " x 26 ²³ / ₃₂ "	120	1440	NEMA 5-15P	64 lbs.	6295
GRFHS-PTT16*	2	18 ³³ / ₆₄ " x 22 ¹⁷ / ₃₂ " x 22 ¹ / ₂ "	120	1300	NEMA 5-15P	65 lbs.	6124
GRFHS-PTT21**	2	24 ²⁵ / ₃₂ " x 38" x 22 ¹ / ₂ "	120	1740	NEMA 5-20P	100 lbs.	6171

- ↔ Add 1/4" to width if ordering Scoop Holder.
- ▶ Standard with fixed scoop holder (not accessory FHS-SH).
- ♣ Includes a built-in 6" deep heated food holding base (4" is standard on all other models).

All Portable Fry Holding Station Models Feature:

Models Shipped with: One slotted holding bin and one sectional divider.
Cord Location: GRFHS-16, -21, -22, -26, -PT16, -PT26, -PTT16: Back side, lower right corner.
GRFHS-PTT21: Lower right-hand side.

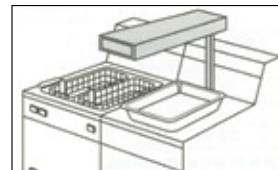

GRFS, GRFSL, GRFSC, GRFSL with swing-away post mount and cord with plug

Fry Stations

FRY STATION WARMERS

Model	No. of Bulbs	Dimensions (W x D x H)	Voltage (Single Phase)	Watts	Plug	Approx. Ship Weight	List Price
GRFSC-18 [⊖]	–	6" x 18" x 19 ¹ / ₄ "-22 ¹ / ₂ "	120	750	NEMA 5-15P	11 lbs.	\$1134
GRFSL-18 [⊖]	2	9" x 18" x 19 ¹ / ₄ "-22 ¹ / ₂ "	120	870	NEMA 5-15P	13 lbs.	1369
GRFSCR-18 ^{⊖†}	–	6" x 18" x 19 ¹ / ₄ "-22 ¹ / ₂ "	120	750	–	12 lbs.	1135
GRFSLR-18 ^{⊖†}	2	9" x 18" x 19 ¹ / ₄ "-22 ¹ / ₂ "	120	870	–	14 lbs.	1369
GRFS-24 [⊖]	–	6" x 24" x 12 ¹ / ₂ "-15 ¹ / ₂ "	120	500	NEMA 5-15P	10 lbs.	919
GRFSL-24 [⊖]	2	9" x 24" x 12 ¹ / ₂ "-15 ¹ / ₂ "	120	620	NEMA 5-15P	13 lbs.	1169
GRFSR-24 ^{⊖†}	–	6" x 24" x 12 ¹ / ₂ "-15 ¹ / ₂ "	120	500	–	10 lbs.	919
GRFSLR-24 ^{⊖†}	2	9" x 24" x 12 ¹ / ₂ "-15 ¹ / ₂ "	120	620	–	13 lbs.	1169

- ⊖ Specify clearance of 16³/₄", 18" (standard) or 20" when ordering.
- † Fry Station Warmer without cord and plug, C-UR recognized. Supply wires through mounting post.
- ⊖ Specify clearance of 10", 11", 12" or 13" (standard) when ordering.

All Fry Station Warmer Models Feature:

Toggle Switch Location: Ceramic Heating Element Models: Back of unit.
Metal Sheathed Heating Element Models: Front of unit.
Cord Location GRFSC-18, GRFSL-18, GRFS-24 and GRFSL-24: Back, upper middle.

OPTIONS AND ACCESSORIES – PAGE 139

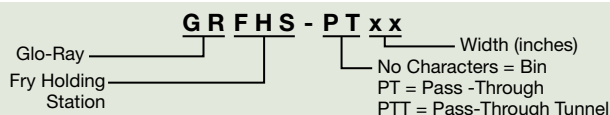

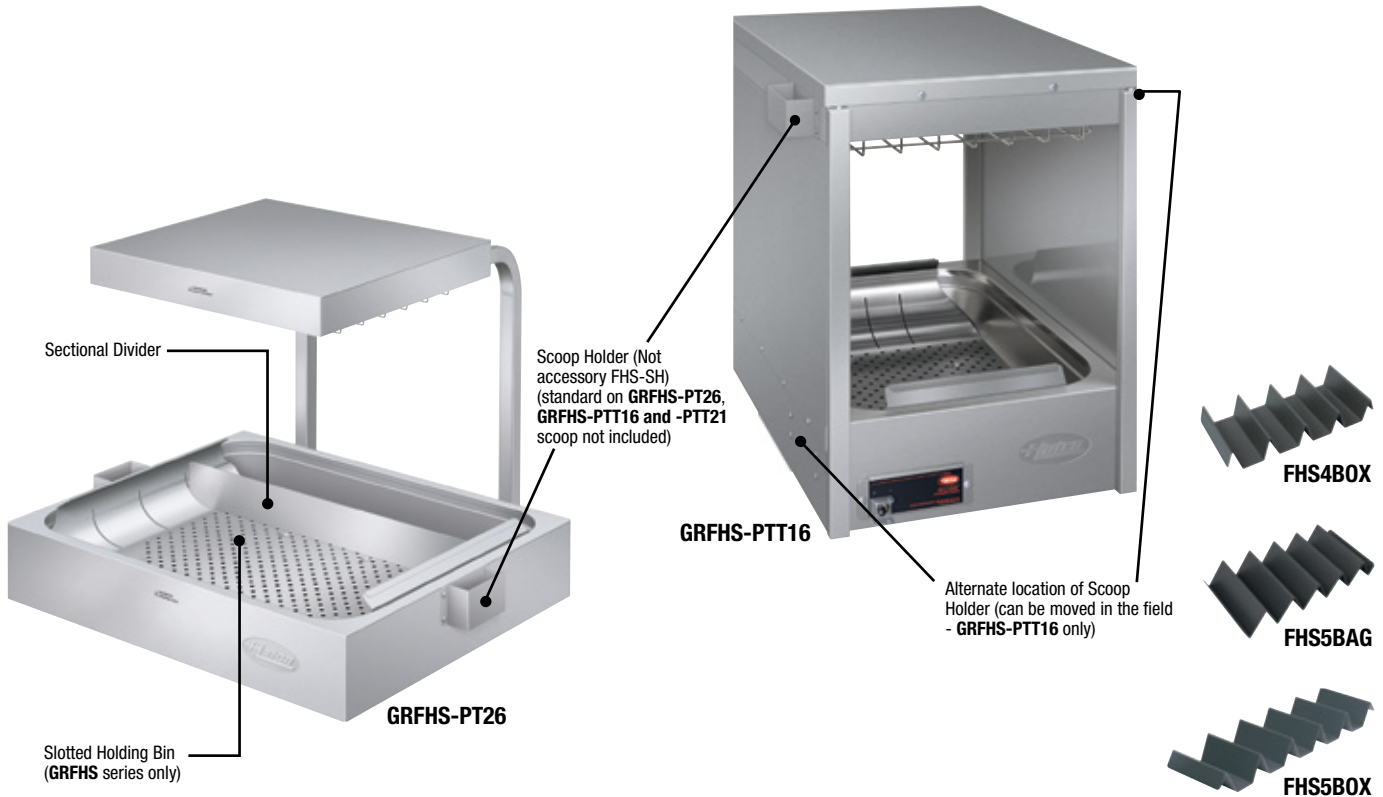

OPTIONS (available at time of purchase only)

FHS-CUT	Right- or Left-Hand Cutout for Fry Basket – must specify side at time of order Adds 1 1/16" to width of unit (GRFHS-16, -21, -26 models only)	No Charge
INF	Infinite Control (metal sheathed GRFS models only)	\$ 74
HAL	60 Watt Halogen Bulb in lieu of standard Display Light	each 102

ACCESSORIES (available for purchase at any time)

FHS4BOX	Four-Pleat Hardcoated Fry Box Ribbon (All models) – 10 3/4"W x 5"D x 1 3/4"H	\$142
FHS5BAG	Five-Pleat Hardcoated Fry Bag Ribbon (All models) – 11 1/4"W x 5"D x 1 7/8"H	142
FHS5BOX	Five-Pleat Hardcoated Fry Box Ribbon (GRFHS-21, -PT26, -PTT16, -PTT21) – 17 1/2"W x 5"D x 1 7/8"H	231
FHS6BAG	Six-Pleat Hardcoated Fry Bag Ribbon (GRFHS-21, -PT26, -PTT16, -PTT21) – 13 3/4"W x 5"D x 2"H	156
FHS6BB	Six-Pleat Hardcoated Fry Box/Bag Ribbon (GRFHS-21, -PT26, -PTT16, -PTT21) – 17 1/4"W x 5"D x 1 3/4"H	231
FHS7BAG	Seven-Pleat Hardcoated Fry Bag Ribbon (GRFHS-21, -PT26, -PTT21) – 17 7/8"W x 5"D x 1 7/8"H	231
PTT16-10BAG	Ten-Pleat Hardcoated Hashbrown Ribbon – (GRFHS-PT26, -PTT21) – 15"W x 3 3/8"D x 1 3/4"H	218
5BH	5" Side-by-Side Bag Holder (GRFHS-21)	95
FHS-SH	Scoop Holder – adds 1 1/4" to width of unit – Differs from standard on GRFHS-PT26, -PTT16 & -PTT21 models, not available for GRFHS-22 (Scoop Holder on GRFHS-PTT16 can be moved to two alternate locations in the field)	95
FHSDIV1	Sectional Divider – 16" W x 3 3/4" H – GRFHS-16, -26 and -PTT16 models	56

Chef LED 120V adjustable bulb – bulbs must be rotated down –

CLED-3000-120	Similar to warm Halogen light	CLED-4000-120	Similar to cool Fluorescent light	each \$205
----------------------	-------------------------------	----------------------	-----------------------------------	-------------------

FOOD PANS AND TRIVETS – PAGE 240



CLED-3000 and -4000
Accessory

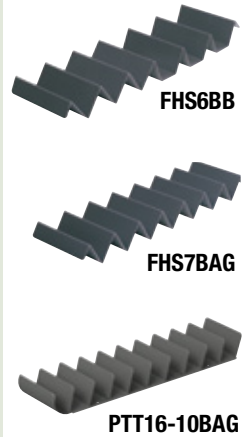

Fry Stations

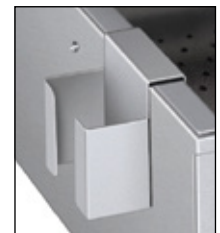

FHS-SH



Multi-Product Warming Stations

Hatco's redesigned Multi-Product Warming Station safely holds hot fried foods at optimum serving temperatures in kitchen work areas. The unit is designed for maximum durability and performance with minimum maintenance.

- New removable left/right side panel
- New wider, deeper side openings
- Easy access to food product
- Coated shatter-resistant incandescent lights enhance brilliant product display while safeguarding food from bulb breakage

- Six overhead ceramic heating elements are adjusted by two separate electronic infinite controls – one for the rear elements and one for the front elements
- Thermostatically controlled base heat assures safe serving temperatures
- All stainless steel construction
- Master On/Off rocker switch

ENDLESS POSSIBILITIES OF CONFIGURATION

Incremental spacing between portable dividers is 5/8"



MPWS-36 with accessory angled risers, fry pan and trivet (plastic pans not available)



Shown with accessory fry bin insert and standard detachable side panel on right side



Shown with optional fry pans, accessory fry ribbon on angled riser and accessory scoop holder



Shown with optional fry pans, and accessory angled riser and scoop holder (plastic pans not available)



Shown with accessory fry ribbons on angled risers, fry pan and scoop holder (plastic pans not available)

MULTI-PRODUCT WARMING STATIONS

Model	No. of Bulbs	Dimensions W x D x H	Watts		Plug	Approx. Ship Weight	List Price
			120/208V	120/240V			
MPWS-36	4	37 ⁷ / ₁₆ " x 24 ¹³ / ₁₆ " x 32 ³ / ₄ "	2773	2755	NEMA L14-20P	152 lbs.	\$8751
MPWS-45	4	45 ⁷ / ₁₆ " x 24 ¹³ / ₁₆ " x 32 ³ / ₄ "	2799	2780	NEMA L14-20P	170 lbs.	9787

All Multi-Product Warming Station Models Feature:

Models Shipped with: 4" adjustable legs.

Cord Location: Back side, upper left corner.

OPTION CAPACITIES

Model	Option Capacities	
	Fry Pan with Trivet	Angled Risers
MPWS-36	1	3
	2	1
	0	5
MPWS-45	1	4
	2	2
	0	6

OPTIONS (available at time of purchase only)

HAL	60 Watt Halogen Bulb in lieu of standard Display Light	each \$102
-----	--	------------

ACCESSORIES (available for purchase at any time)

FHS4BOX	Four-Pleat Hardcoated Fry Box Ribbon – 10 ³ / ₄ "W x 5"D x 1 ¹ / ₄ "H	\$142
FHS5BAG	Five-Pleat Hardcoated Fry Bag Ribbon – 11 ¹ / ₄ "W x 5"D x 1 ⁷ / ₈ "H	142
5BH	5" Side-by-Side Bag Holder	95
FHS-SH	Scoop Holder	95
MPWS-RISER	Angled Riser	189
MPWS-PT	Fry Pan and Trivet	832
MPWS36BIN	Full Fry Bin Insert for MPWS-36 unit only (includes Drip Tray, Perforated Insert and 3 Dividers)	each 788
MPWS45BIN	Full Fry Bin Insert for MPWS-45 unit only (includes Drip Tray, Perforated Insert and 4 Dividers)	each 843

Chef LED 120V adjustable bulb – bulbs must be rotated down –

CLED-3000-120	Similar to warm Halogen light	CLED-4000-120	Similar to cool Fluorescent light	each 205
---------------	-------------------------------	---------------	-----------------------------------	----------

FOOD PANS AND TRIVETS – PAGE 240



CLED-3000 and -4000 Accessory

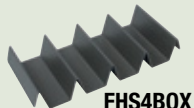

FHS4BOX

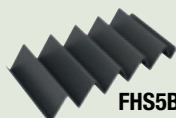

FHS5BAG

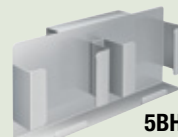

5BH



FHS-SH



MPWS36BIN



MPWS-PT



MPWS-RISER

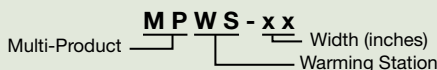



Portable Foodwarmers

Opt for the versatility of Hatco's Glo-Ray® and Ultra-Glo® Portable Foodwarmers. With heat from above, below or both, these foodwarmers offer design flexibility without sacrificing food product quality. Ideal for use next to fry stations, drive-through windows and service areas that require frequent and easy access.

- Portable – ready to plug in and use
- Versatile – available in many sizes, styles and heat sources to fit your needs
- Flexible – both top and bottom heat available
- Available with incandescent bulbs containing special protective coating to guard against food contamination
- Ceramic heating elements provide more distance between the heat source and the holding pan (UGFF series only)
- Toggle switch is standard; infinite switch optional on GRFF series
- All base heat units (GR-B, GRFFB and UGFFB) have a preset automatic thermostat to maintain consistent temperatures



GR-B Heated Base with accessory sheet pan

GRFFB with optional infinite switch and accessory food pans



UGFFL in optional Radiant Red Gloss finish with accessory fry ribbon and food pan



Quick-Ship Program Information Inside Back Cover

GLO-RAY® PORTABLE FOODWARMERS

Model	No. of Bulbs	Dimensions W x D x H	Voltage Single Phase	Watts	Plug	Approx. Ship Weight	List Price
GR-B	–	12 ³ / ₄ " x 22" x 2 ¹ / ₄ "	120	250	NEMA 5-15P	14 lbs.	\$1070
GRFF	–	12 ³ / ₈ " x 24" x 15 ⁷ / ₈ "	120	500	NEMA 5-15P	14 lbs.	1058
GRFFL	2	12 ³ / ₈ " x 24" x 15 ⁷ / ₈ "	120	620	NEMA 5-15P	14 lbs.	1360
GRFFB [⚡]	–	12 ³ / ₄ " x 24" x 16"-20"	120	750	NEMA 5-15P	29 lbs.	1740
GRFFBL [⚡]	2	12 ³ / ₄ " x 24" x 16"-20"	120	870	NEMA 5-15P	34 lbs.	2000

[⚡] Standard clearance is 14". Specify 12" or 16" if required.
[⚡] Quick-Ship model available in 14" clearance only (18" overall height).

All Portable Models Feature:

Models Shipped with: 6' cord and plug.
 Cord Location: GR-B, GRFFB, GRFFBL: Back, lower middle.
 GRFF, GRFFL: Back, upper middle.

Quick-Ship Program Information Inside Back Cover

ULTRA-GLO® PORTABLE FOODWARMERS WITH CERAMIC ELEMENTS

Model	No. of Bulbs	Dimensions W x D x H	Voltage Single Phase	Watts	Plug	Approx. Ship Weight	List Price
UGFF	–	12 ³ / ₈ " x 22 ¹ / ₄ " x 18 ⁷ / ₈ "	120	750	NEMA 5-15P	15 lbs.	\$1325
UGFFL	2	12 ³ / ₈ " x 22 ¹ / ₄ " x 18 ⁷ / ₈ "	120	870	NEMA 5-15P	17 lbs.	1634
UGFFB	–	12 ³ / ₄ " x 22 ¹ / ₂ " x 22"	120	1000	NEMA 5-15P	25 lbs.	1994
UGFFBL	2	12 ³ / ₄ " x 22 ¹ / ₂ " x 22"	120	1120	NEMA 5-15P	34 lbs.	2311

All Ceramic Portable Models Feature:

Models Shipped with: 6' cord and plug.
 Cord Location: UGFF, UGFFL: Back, upper middle.
 UGFFB, UGFFBL: Back, lower middle.

OPTIONS AND ACCESSORIES – PAGE 142

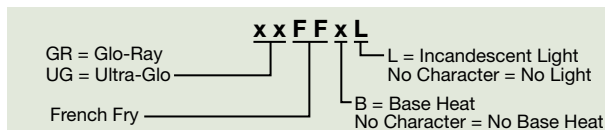

Fry Stations



UGFFB with accessory food pan (perforated pan not available)

OPTIONS (available at time of purchase only)

Designer Colors (one color per unit, heated base is not powdercoated, not available for GR-B models)

Non-standard colors are non-returnable – Clear Anodized standard –

RED	Warm Red	\$242
BLACK	Black	242
GRAY	Gray Granite	242
WHITE	White Granite	242
NAVY	Navy Blue	242
GREEN	Hunter Green	242
COPPER	Antique Copper	242

Gloss Finishes (one color per unit, heated base is not painted, not available for GR-B models)

Non-standard colors are non-returnable –

RRED	Radiant Red	\$336
GGOLD	Gleaming Gold	336
GGRAY	Glossy Gray	336
BBLUE	Brilliant Blue	336
BBLACK	Bold Black	336

Clearance (from bottom of Glo-Ray® to top of heated surface) – GRFFB, GRFFBL only – 14" standard –

12"	No Charge
16"	No Charge

SIGN HOLD	Sign Holder for GRFFL model with Back Toggle only (requires 9"W x 5½"H x ¼"D sign, which is not included and adds 3" to height of unit)	\$76
INF	Infinite Control (not available on models GR-B, UGFF, UGFFL, UGFFB or UGFFBL)	76
HAL	60 Watt Halogen Bulb in lieu of standard Display Light	each 102

ACCESSORIES (available for purchase at any time)

5PLTBOX	Five-Pleat Hardcoated French Fry Box Ribbon – 19¼"W x 9¼"D x 2"H	\$371
8PLTBAG	Eight-Pleat Hardcoated French Fry Bag Ribbon – 19¼"W x 9¼"D x 2"H	371

Chef LED 120V adjustable bulb – bulbs must be rotated down – excludes any model without existing bulbs –

CLED-3000-120 Similar to warm Halogen light	CLED-4000-120 Similar to cool Fluorescent light	each 205
--	--	-----------------

FOOD PANS AND TRIVETS – PAGE 240

COLORS AND FINISHES – PAGE 241



CLED-3000 and -4000 Accessory

Fry Stations



Portable Lamp Warmer

The portable, powdercoated Hatco Lamp Warmer has a specially-designed stand that keeps food holding pans above the countertop and provides insulation to extend holding times.

- Features two vented lamps with heavy-duty sockets
- Adjustable stand from 24³/₈" to 30³/₈" in height
- Cord and plug with in-line power switch

- Gray Granite is Standard color with optional *Designer Colors* available: Warm Red, Black, Gray Granite, White Granite, Navy Blue, Hunter Green, Antique Copper (non-standard colors are non-returnable)
- Holds food pans, wire trivets and fry ribbons



LW-2 in optional *Designer* Black with Accessory food pans

PORTABLE LAMP WARMER

Model	No. of Bulbs	Dimensions W x D x H	Voltage Single Phase	Watts	Plug	Approx. Ship Weight	List Price
LW-2	2	12 ³ / ₈ " x 21 ³ / ₈ " x 24 ³ / ₈ "-30 ³ / ₈ "	120	500	NEMA 5-15P	18 lbs.	\$1287

All Portable Lamp Warmer Models Feature:

Bulbs: Two 250 Watt *uncoated* clear bulbs.

Cord Location: 6' cord and plug, located back of adjustable stand near top.

Lamp Distance: 10¹/₂"-16¹/₂" space from bottom of lamp to top of base.

OPTIONS (available at time of purchase only)

Designer Colors – Non-standard colors are non-returnable – Gray Granite standard –

RED	Warm Red	No Charge
BLACK	Black	No Charge
WHITE	White Granite	No Charge
NAVY	Navy Blue	No Charge
GREEN	Hunter Green	No Charge
COPPER	Antique Copper	No Charge

ACCESSORIES (available for purchase at any time)

WHITE-CTD-120	250 Watt Clear Bulb, Coated (unit accommodates two bulbs)	each \$59
RED-UCTD-120	250 Watt Red Bulb, Uncoated (unit accommodates two bulbs)	each 58
RED-CTD-120	250 Watt Red Bulb, Coated (unit accommodates two bulbs)	each 74

FRY RIBBONS – PAGE 139

FOOD PANS AND TRIVETS – PAGE 240

COLORS AND FINISHES – PAGE 241

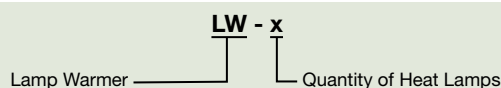

Carving Stations & Buffet Warmers





Decorative Carving Stations

An eye-catching solution for carving and serving, the Hatco Decorative Carving Station features a stylish Decorative Lamp and is available in multiple configurations, including post mount, counter mount, and freestanding models with an integrated heated simulated stone base. Designed to deliver both visual appeal and reliable performance, these stations are ideal for chefserved presentations in restaurants, hotels, country clubs, casinos, and catered events.

- Available as freestanding (DCSB2 models) with a round or rectangular heated simulated stone base, post mount (DCS400-1 models), or counter mount (DCS400-1CM models)
- Patented telescoping heated Decorative Lamp(s) has a 30° shade pivot
- DCSB2 models include a thermostatically controlled heated base and matching cutting board, both made of foodsafe materials
- DCSB2 models feature posts that fold down for convenient transportation and compact storage of units and a removable sneeze guard
- DCS400-1 models include a 40 lb. weighted base for stability
- DCS400-1CM models are designed to be mounted to a countertop
- Models with simulated stone are Swanstone®

DCS400-1CM
with optional Bright Brass post & shade and Bermuda Sand simulated stone trim ring



DCSB2-R24-1
with standard Bright Nickel post & shade and optional Bermuda Sand simulated stone heated base



DCSB2-3624-2
with standard Bright Nickel posts & shades and Night Sky simulated stone heated base



DECORATIVE CARVING STATIONS

Model	No. of Lamps	Width	Heated Base Surface Area	Voltage Single Phase	Watts	Plug	Approx. Ship Weight	List Price
DCS400-1	1	8"	—	120	250	NEMA 5-15P	32 lbs.	\$ 2609
DCS400-1CM	1	6 1/8"	—	120	250	NEMA 5-15P	18 lbs.	2555
DCSB2-R24-1	1	26"	24" diameter	120	600	NEMA 5-15P	75 lbs.	7452
DCSB2-2420-1	1	24"	24"W x 20"D	120	750	NEMA 5-15P	82 lbs.	8854
DCSB2-3624-2	2	36"	36"W x 24"D	120	1300	NEMA 5-15P	128 lbs.	11645



All Decorative Carving Station Models Feature:

- Models Ship with: **DCS400-1, -1CM:** One clear coated bulb. **DCS400-1** includes black base.
- DCSB2-R24-1, -2420-1:** One clear coated bulb, base heat, glass sneeze guard and cutting board.
- DCSB2-3624-2:** Two clear coated bulbs, base heat, glass sneeze guard and cutting board.
- Telescoping Clearance: **DCS400-1, -1CM:** (bottom of shade to counter) 16"-28".
- DCSB2-R24-1, -2420-1, -3624-2:** (bottom of shade to top of cutting board) 14"-26".
- Cord Location: **DCS400-1:** Base of unit, server side center. **DCS400-1CM:** Under counter.
- DCSB2-R24-1, -2420-1, -3624-2:** Base of unit, server side on left.

DCS400-1
with optional Bright Brass post and shade and black base



OPTIONS (available at time of purchase only)

- Shade and post(s) in Plated Finish, no additional charge –
- Non-Standard colors are non-returnable – Bright Nickel Standard –
- BBRASS** Bright Brass **No Charge**
- BCOPPER** Bright Copper **No Charge**
- ABRASS** Antique Brass **No Charge**
- ABRONZE** Antique Bronze **No Charge**

- Base and Cutting Board (except DCS400-1, -1CM) in simulated stone[®], no additional charge – Non-Standard colors are non-returnable –
- Night Sky Standard –
- GGRAN** Gray Granite **No Charge**
- BSAND** Bermuda Sand **No Charge**

- Trim Ring (DCS400-1CM only) in simulated stone[®], no additional charge –
- Non-Standard colors are non-returnable – Night Sky Standard –
- GGRAN** Gray Granite **No Charge**
- BSAND** Bermuda Sand **No Charge**

[®] Our current Swanstone simulated stone options — Bermuda Sand, Gray Granite and Night Sky — will be discontinued at the end of 2025. We will introduce new Swanstone simulated stone options on January 1, 2026.

ACCESSORIES (available for purchase at any time)

RED-CTD-120	120 Volt, 250 Watt, Red Bulb, Coated	each	\$74
--------------------	--------------------------------------	------	-------------

COLORS AND FINISHES – PAGE 241



Close-up of **Trim Ring** in Standard Night Sky (Unit shown in Optional Plated Antique Bronze finish)

DCSB2xxx-xxxx-xCM

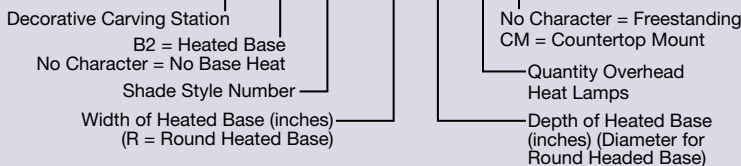



Glo-Ray® Carving Stations

An excellent addition to extend food holding times during serving periods is the Glo-Ray® Carving Station. Create a complete serving station for buffets by adding it to Hatco's Flav-R-Savor® Holding Cabinet.

- Overhead ceramic heating elements project high intensity radiant heat over entire target area
- Adjustable clearance of 17½" to 23½"
- Portable – includes a 6' cord and plug
- Shatter-resistant incandescent lights illuminate holding area
- Drip pan and cutting board available
- GRCSCLH has base heat



GRCSCL-24 with accessory left-hand sneeze guard, drip pan and cutting board



GRCSCLH-24 with accessory left-hand sneeze guard, drip pan and cutting board



GRCSCLH-24 controls

CARVING STATIONS

Model	No. of Bulbs	Dimensions W [↔] x D x H	Voltage Single Phase	Watts	Plug	Approx. Ship Weight	List Price
GRCSCL-24	4	26" x 28" x 22½"-28½"	120	990	NEMA 5-15P	57 lbs.	\$6012
GRCSCLH-24	4	26" x 28" x 22½"-28½"	120	1290	NEMA 5-15P	57 lbs.	6788

↔ Width includes accessory left-hand sneeze guard.

All Carving Station Models Feature:

Models Shipped with: Right-hand sneeze guard.
Cord Location: Back side on base.

OPTIONS (available at time of purchase only)

HAL	60 Watt Halogen Bulb in lieu of Standard Display Light	each \$102
------------	--	------------

ACCESSORIES (available for purchase at any time)

CSCLB/PACC	Left-Hand Sneeze Guard Kit (3 lbs.)	\$457
CSCL-PAN	Stainless Steel custom Drip Pan – 20" x 26¾" x 1" – (9 lbs.)	472
CSCL-BOARD	Approved foodsafe Cutting Board – 18" x 24" x 1¾" – (19 lbs.)	445

Chef LED 120V adjustable bulb – bulbs must be rotated down –

CLED-3000-120	Similar to warm Halogen light	CLED-4000-120	Similar to cool Fluorescent light	each \$205
----------------------	-------------------------------	----------------------	-----------------------------------	------------



CSCLB/PACC

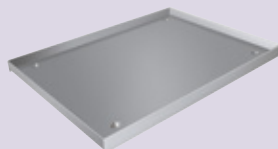

CSCL-PAN



CSCL-BOARD



CLED-3000 and -4000
Accessory

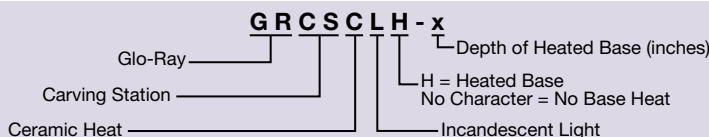

Carving Stations & Buffet Warmers



Glo-Ray® Buffet Warmers

Hold hot food at optimum serving temperatures on buffet lines or at temporary serving areas with Hatco Glo-Ray® Buffet Warmers. Choose from either Standard or *Designer* style models in many widths to fit your operation.

- Available with *Designer* Color insets with the choice of an entire unit in color as well
- Thermostatically-controlled heated base of 80°- 200°F extends holding times of most foods
- Pre-focused infrared top heat directs heat to the outer edges where heat loss is greatest
- Sturdy plexi-glass Sneeze Guard
- Shatter-resistant incandescent lights enhance product displays while safeguarding food from bulb breakage
- Available in a variety of widths from 25"-78¼"
- Optional infinite control for top heat only



GRBW-30 in optional *Designer* Navy Blue and Accessory food pans



GR2BW-30 with optional *Designer* Warm Red inset panels and Accessory food pans



GR2BW-30 in optional *Designer* Black and plexi-glass side enclosures plus Accessory food pans

GLO-RAY BUFFET WARMERS

Model	No. of Light Bulbs	Dimensions W x D x H Includes sneeze guard	Maximum Pan Capacity 12" x 20" pan	Voltage	Watts	Plug	Approx. Ship Weight	List Price
GRBW-24 [✓]	2	25" x 22½" x 17¾"	1	120	970	NEMA 5-15P	46 lbs.	\$3430
GRBW-30 [✓]	2	31" x 22½" x 17¾"	2	120	1230	NEMA 5-15P	52 lbs.	3796
GRBW-36 [✓]	3	37" x 22½" x 20¾"	2	120	1530	NEMA 5-20P	58 lbs.	4163
GRBW-42 [✓]	3	43" x 22½" x 20¾"	3	120	1730	NEMA 5-20P	68 lbs.	4529
GRBW-48 [⊖]	4	49" x 22½" x 20¾"	3	120/208-240	2040	NEMA L14-20P	75 lbs.	4895
GRBW-54 [⊖]	4	55" x 22½" x 20¾"	4	120/208-240	2290	NEMA L14-20P	81 lbs.	5262
GRBW-60 [⊖]	5	61" x 22½" x 20¾"	4	120/208-240	2600	NEMA L14-20P	90 lbs.	5628
GRBW-66 [⊖]	5	67" x 22½" x 20¾"	5	120/208-240	2860	NEMA L14-20P	96 lbs.	5994
GRBW-72 [⊖]	5	73" x 22½" x 20¾"	5	120/208-240	3125	NEMA L14-20P	107 lbs.	6361

[✓] Available in 120/208-240V, NEMA L14-20P.
[⊖] Not available in 120V.

All Glo-Ray Buffet Warmer Models Feature:

GRBW base dimensions: 25"-73"W x 19½"D.

Cord Location: 6' cord and plug located on base end plate, same side as switch.

GLO-RAY DESIGNER BUFFET WARMERS

Model [⊗]	No. of Light Bulbs	Dimensions W x D x H Includes sneeze guard	Maximum Pan Capacity 12" x 20" pan	Voltage	Watts	Plug	Approx. Ship Weight	List Price
GR2BW-24 [✓]	2	30¼" x 27" x 19"	1	120	970	NEMA 5-15P	76 lbs.	\$ 6123
GR2BW-30 [✓]	2	36¼" x 27" x 22"	2	120	1230	NEMA 5-15P	85 lbs.	6700
GR2BW-36 [✓]	2	42¼" x 27" x 22"	2	120	1470	NEMA 5-20P	97 lbs.	7277
GR2BW-42 [✓]	4	48¼" x 27" x 22"	3	120	1790	NEMA 5-20P	110 lbs.	8044
GR2BW-48 [⊖]	4	54¼" x 27" x 22"	3	120/208-240	2040	NEMA L14-20P	125 lbs.	8811
GR2BW-54 [⊖]	4	60¼" x 27" x 22"	4	120/208-240	2290	NEMA L14-20P	130 lbs.	9726
GR2BW-60 [⊖]	6	66¼" x 27" x 22"	4	120/208-240	2660	NEMA L14-20P	154 lbs.	10640
GR2BW-66 [⊖]	6	72¼" x 27" x 22"	5	120/208-240	2920	NEMA L14-20P	169 lbs.	11391
GR2BW-72 [⊖]	6	78¼" x 27" x 22"	5	120/208-240	3185	NEMA L14-20P	186 lbs.	12142

[⊗] When no color is specified, color inset panels and corner caps will be black.
[✓] Available in 120/208-240V, NEMA L14-20P.
[⊖] Not available in 120V.

All Glo-Ray Designer Buffet Warmer Models Feature:

Usable Heated Shelf Space: Width of unit minus 6½" x 21¾"D.

Cord Location: 6' cord and plug located on center of bottom on control side.

OPTIONS AND ACCESSORIES – PAGE 148





GRBW-30 with Accessory Food Pans

OPTIONS (available at time of purchase only)

Designer Colors – Non-standard colors are non-returnable – Clear Anodized Aluminum standard –

RED	Warm Red	\$748
BLACK	Black	748
GRAY	Gray Granite	748
WHITE	White Granite	748
NAVY	Navy Blue	748
GREEN	Hunter Green	748
COPPER	Antique Copper	748

Designer Inset Panel colors, GR2BW models – Non-standard colors are non-returnable – Black standard –

RED	Warm Red	No Charge
GRAY	Gray Granite	No Charge
WHITE	White Granite	No Charge
NAVY	Navy Blue	No Charge
GREEN	Hunter Green	No Charge
COPPER	Antique Copper	No Charge

Designer Corner Caps, GR2BW models – Non-standard colors are non-returnable – Black standard –

DKGRAY	Dark Gray	No Charge
---------------	-----------	------------------

Plexi-Glass Front and two Side Enclosures in lieu of Sneeze Guards – Available for GRBW-24, -30, -36, -42 and -48 models only –

FRTENCL-24, -30	-24 and -30 models	\$671
FRTENCL-36, -42, -48	-36, -42, & -48 models	763
SIDE-ENCL	Two Plexi-Glass Side Enclosures (GRBW models only)	456
SIDE-ENCL2	Two Plexi-Glass Side Enclosures (GR2BW models only)	456

Hardcoat Aluminum Surface, GRBW models –

HC 24-42	GRBW-24 through GRBW-42	\$238
HC 48-72	GRBW-48 through GRBW-72	477
INF	Infinite Control for top heat only (GRBW-24 through GRBW-60 and GR2BW-24 through GR2BW-60 models only)	\$76
9.375BP	9 3/8" Sneeze Guard in lieu of standard 7 1/2" (GRBW models only)	per foot per side 21
14BP	14" Sneeze Guard in lieu of standard 7 1/2"	per foot per side 41
HAL	60 Watt Halogen Bulb in lieu of standard Display Light	each 102

ACCESSORIES

GRBW-LEGS	4" adjustable legs for GRBW-24 models (standard on GRBW-42 or wider)	\$ 98
2SD-LEGS	4" Designer Legs for GR2BW-24 models (standard on GR2BW-30 or wider)	178
Pan Rail for GRBW models (not for use with Plexi-Glass front enclosure)		
2 RAIL	2-pan	\$307
3 RAIL	3-pan	332
4 RAIL	4-pan	618
5 RAIL	5-pan	640
Chef LED 120V adjustable bulb – bulbs must be rotated down –		
CLED-3000-120	Similar to warm Halogen light	each 205
CLED-4000-120	Similar to cool Fluorescent light	

FOOD PANS AND TRIVETS – PAGE 240

COLORS AND FINISHES – PAGE 241

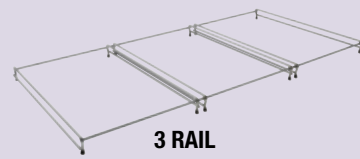

Carving Stations & Buffet Warmers



Glo-Ray® Curved Warmers

Looking to add a touch of class to a new point-of-sale area or to change or upgrade an existing area? Hatco's Glo-Ray® Curved Merchandising Warmer offers a unique and attractive solution for impulse sales areas.

- Single shelf and dual shelf units come standard with mirrored glass back panel
- Individual thermostatically-controlled heated base with master rocker switch maintains safe serving temperatures
- Halogen lighting allows for optimal food product display

- Humidified dual shelf unit contains a five cup capacity water reservoir
- Models with Simulated Stone are Swanstone®



GRCMW-1 in standard Designer Black with food pans (not available)



GRCMW-1DH in standard Designer Black with food pans (not available)

GLO-RAY CURVED WARMERS

Model	Dimensions W x D x H	Voltage Single Phase	Usable Heated Surface Space (W x D)		Watts	Plug	Approx. Ship Weight	List Price
			Top Shelf	Bottom Shelf				
Single Shelf								
GRCMW-1	22 ¹ / ₈ " x 21 ¹ / ₂ " x 19 ⁷ / ₈ "	120	—	19 ³ / ₄ " x 13"	670	NEMA 5-15P	56 lbs.	\$5660
Dual Shelf								
GRCMW-1D	26" x 20 ¹ / ₈ " x 26 ⁷ / ₈ "	120	22 ³ / ₄ " x 12 ³ / ₈ "	22 ³ / ₄ " x 15 ⁵ / ₈ "	1540	NEMA 5-20P	92 lbs.	\$10848
Dual Shelf with Humidity								
GRCMW-1DH♦	26" x 20 ¹ / ₈ " x 26 ⁷ / ₈ "	120	22 ³ / ₄ " x 12 ³ / ₈ "	22 ³ / ₄ " x 15 ⁵ / ₈ "	1660	NEMA 5-20P	100 lbs.	\$11606

♦ Humidity on bottom shelf only.

All Curved Merchandising Warmer Models Feature:
 Water Reservoir Capacity (GRCMW-1DH model only): 5 cups.
 Cord Location: Server side, bottom right corner.

WATER QUALITY REQUIREMENTS – PAGE 242

OPTIONS (available at time of purchase only)

Designer Colors (Unit's painted surface) – Non-standard colors are non-returnable – Black standard –

RED	Warm Red	No Charge
GRAY	Gray Granite	No Charge
WHITE	White Granite	No Charge
NAVY	Navy Blue	No Charge
GREEN	Hunter Green	No Charge
COPPER	Antique Copper	No Charge

Simulated Stone Color (unit's painted surface and decorative trim inserts) – Non-standard colors are non-returnable –

GGRAN	Gray Granite	No Charge
BSAND	Bermuda Sand	\$992
NSKY	Night Sky	992

CMWDBACKFLIP Top and bottom shelf flip-up doors on server's side in lieu of mirrored back panel (GRCMW-1D, -1DH Models only) **\$ 66**

CMWDTOPFLIP Top Shelf Flip-up Door on Customer Side in lieu of Sneeze Guard (GRCMW-1D, -1DH Models only) **336**

Ⓢ **Our current Swanstone simulated stone options — Bermuda Sand, Gray Granite and Night Sky — will be discontinued at the end of 2025. We will introduce new Swanstone simulated stone options on January 1, 2026.**

FOOD PANS AND TRIVETS – PAGE 240
COLORS AND FINISHES – PAGE 241

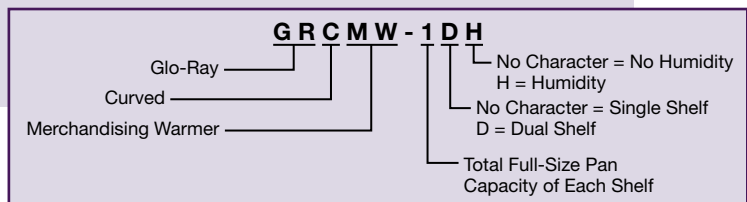

Carving Stations & Buffet Warmers



Glo-Ray® Mini-Warmers

Hatco's convenient Glo-Ray® Mini-Merchandisers create impulse sales by placing fresh product in front of customers. Using limited amount of valuable counterspace, these flexible warmers come in a variety of shapes, sizes and colors to hold food samples, hors d'oeuvres and packaged product at just the right temperature.

- Ideal for areas with limited counterspace
- Thermostatically-controlled heated base extends holding times of most foods
- Pre-focused infrared top heat directs heat to the outer edges where heat loss is the greatest
- Food stop, 4" food bins are Standard (GRHW-1SG and -1SGS only)
- Lighted rocker switch for easy On/Off



GRHW-1P with Accessory food pan



GRHW-2P with Standard 4" legs and Accessory food pans



GRHW-1SG with Standard bins



GRHW-1SGDS in Standard Designer Black

GLO-RAY MINI-WARMERS

Model	Description	Dimensions W x D x H Includes sneeze guard	Voltage Single Phase	Watts	Plug	Base/Shelf Dimensions W x D	Approx. Ship Weight	List Price
Single Shelf								
GRHW-1P	Hors d'oeuvres warmer, 2 bulbs	22¼" x 16⅝" x 17¾"	120	820	NEMA 5-15P	21" x 13¾"	35 lbs.	\$3213
GRHW-2P*	Hors d'oeuvres warmer, 4 bulbs	43¼" x 16⅝" x 20¾"	120	1640	NEMA 5-15P	42" x 13¾"	67 lbs.	4270
GRHW-1SG	Single horizontal shelf, 2 bulbs	22¼" x 16⅝" x 17¾"	120	820	NEMA 5-15P	21" x 13¾"	37 lbs.	3848
GRHW-1SGS	Single slanted shelf, 2 bulbs	22¼" x 16⅝" x 18¼"	120	820	NEMA 5-15P	21" x 14¼"	40 lbs.	3850
Dual Shelf								
GRHW-1SGD	Dual shelf, 4 bulbs	22⅞" x 20⅜" x 23½"	120	1330	NEMA 5-15P	Bottom: 21" x 13¾" Top: 21" x 14"	40 lbs.	\$7310
GRHW-1SGDS	Hardcoat & slanted base, 4 bulbs	22⅝" x 21" x 23⅝"	120	1330	NEMA 5-15P	Bottom: 21" x 14¼" Top: 21" x 14"	40 lbs.	7635

* Canada uses 5-20P

All Glo-Ray Mini-Merchandiser Models Feature:

Included with Merchandiser: Thermostatically-controlled base, 7½" sneeze guard, display lights, 1" rubber legs (except GRHW-2P has 4" legs), five 4" bins (GRHW-1SG, -1SGS only), 6' cord and plug.

Cord Location: GRHW-1SGD, -1SGDS: Control side, bottom right.

All Other Models: 6' cord and plug, base end plate, same side as switch.

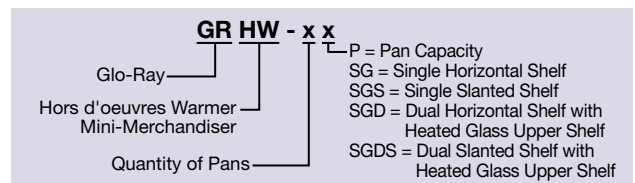

OPTIONS (available at time of purchase only)

Designer Colors – Non-standard colors are non-returnable – Clear Anodized Aluminum standard – (Designer Color included on GRHW-1SGD, 1SGDS units, Designer Black standard)

RED	Warm Red	\$748
BLACK	Black (standard on GRHW-1SGD, 1SGDS units)	748
GRAY	Gray Granite	748
WHITE	White Granite	748
NAVY	Navy Blue	748
GREEN	Hunter Green	748
COPPER	Antique Copper	748
HAL	60 Watt Halogen Bulb in lieu of standard Display Light	each \$102
PANEL	Plexi-Glass Side Panels (GRHW-1P, -2P, -1SG only)	355
1SGD-SLOPE	Sloped Front Sign Holder (GRHW-1SGD, -1SGDS only)	168

ACCESSORIES (available for purchase at any time)

4"LEGS	4" Adjustable Legs (GRHW-1P, -1SG only) – Standard on GRHW-2P	\$ 98
Chef LED 120V adjustable bulb – bulbs must be rotated down –		
CLED-3000-120	Similar to warm Halogen light	each 205
CLED-4000-120	Similar to cool Fluorescent light	each 205

FOOD PANS AND TRIVETS – PAGE 240

COLORS AND FINISHES – PAGE 241



CLED-3000 and -4000 Accessory

Drawer Warmers





Heated Drawer Warmers with Top Control

Hatco Drawer Warmers ensure optimal holding of a variety of products at safe temperatures, while minimizing moisture loss and texture change. Our unique blanket element design promotes uniform temperatures throughout the cavity. Each drawer features adjustable sliding vents. Touchscreen controller controls temperature and time for each drawer individually.

- Top-of-the-unit touchscreen controller is positioned at an angle for greater visibility
- Controller provides individual temperature control and hold timer for each drawer with visual and audio alerts
- Robust stainless steel construction inside and out
- Drawer frame is constructed of heavy duty, 12 gauge stainless steel and drawers slide on durable nylon rollers
- Easy-to-clean seamless interior core
- Snap out side panels make this unit easy to clean and service
- Drawer frame can accommodate varying pan configurations, including full size, half size or one-third size pans up to 6" deep, with or without lids
- Pans lift straight up, eliminating the need to tilt pan for removal
- USB port for easy software updates
- Unit comes standard with removeable 4" plastic legs



HDWTC-2
shown with Accessory 2" casters
(4" plastic legs are standard)

HEATED DRAWER WARMERS WITH TOP CONTROL

Model	Dimensions**		Voltage	Watts	Plug	Approx. Ship Weight	List Price
	W	D x H					
HDWTC-1	24 ¹ / ₂ "	25 ⁵ / ₈ " x 11 ¹¹ / ₁₆ "	120	353	NEMA 5-15P	120 lbs	\$ 6826
HDWTC-2	24 ¹ / ₂ "	25 ⁵ / ₈ " x 20 ¹ / ₈ "	120	704	NEMA 5-15P	178 lbs	9909
HDWTC-3	24 ¹ / ₂ "	25 ⁵ / ₈ " x 28 ⁷ / ₁₆ "	120	1055	NEMA 5-15P	217 lbs	13007

** Add 1³/₈" to depth for drawer handle. Height does not include standard 4" plastic legs.

All Heated Drawer Warmer with Top Control Models Feature:

Models Shipped with: One 6" deep food pan per drawer, 4" plastic legs, 6' cord and plug.
Cord Location: top, back-left side, recessed to protect plug.

OPTIONS (available at time of purchase only)

OS-PAN	Oversized Drawer Frame and Pan (20" x 15" x 5") in lieu of standard Drawer with Pan	per drawer	\$240
--------	---	------------	-------

ACCESSORIES (available for purchase at any time)

HDW-TRIVET	Custom trivet raises food product 1/2" off bottom of full size pan (17 ¹ / ₂ " x 9 ¹ / ₂ " x 1 ¹ / ₂ ")	\$103
HDW 6" LEG	6" adjustable stainless steel Legs	328
HDW-CASTER-2	2" Dia. Casters – all swivel, 2 lock – adds 2 ¹ / ₂ " to height of unit	401
HDW-CASTER-3	3" Dia. Locking Casters – all swivel, all lock – adds 4 ¹ / ₄ " to height of unit	401
HDW-CASTER-5	5" Dia. Locking Casters – all swivel, all lock – adds 6 ¹ / ₄ " to height of unit	481

FOOD PANS AND TRIVETS – PAGE 240

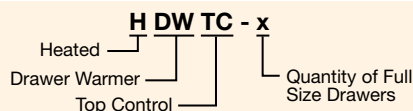



Drawer Warmers

Hold everything from meat to vegetables to rolls in the Hatco Drawer Warmers. Built for tough kitchen duty with rugged construction and heavy-duty hardware, these warmers keep a variety of foods hot and fresh until served.

- Standard and narrow widths
- 1-, 2- or 3-drawer freestanding or built-in models
- Completely insulated individual cavities provide maximum energy efficiency (excludes HDW-1R2, -2R2)
- Each drawer has a food pan, recessed individual thermostatic control, temperature monitor, vent slides and power switch
- 12-gauge stainless steel heavy-duty drawer slides with nylon rollers
- Available with: oversized drawer frame, biscuit pan drawer, chip guard, casters, 6" adjustable stainless steel legs, water/spillage pan and splash baffle
- Standard width Drawer Warmer pans lift straight out of drawer (HDW-1N, -2N, -3N and HDW-1R2, -1.5R2, -2R2 models requiring tipping the pan to install)



HDW-3B



HDW-2 with Accessory 6" stainless steel legs



HDW-2R2 with optional touchscreen control



HDW-1.5R2 with optional touchscreen control

Quick-Ship Program Information Inside Back Cover

FREESTANDING DRAWER WARMERS

Model	Dimensions** W x D x H	Voltage		Watts	Approx. Ship Weight	List Price
		Single Phase	Three Phase			
✓ HDW-1	29½" x 22⅝" x 11"	120, 208, 240		450	97 lbs.	\$ 4483
✓ HDW-2	29½" x 22⅝" x 21⅞"	120, 208, 240		900	168 lbs.	7610
✓ HDW-3	29½" x 22⅝" x 31¼"	120, 208, 240		1350	232 lbs.	10747
HDW-1N	20⅞" x 27" x 11"	120, 208, 240		450	83 lbs.	4483
HDW-2N	20⅞" x 27" x 21⅞"	120, 208, 240		900	168 lbs.	7610
HDW-3N	20⅞" x 27" x 31¼"	120, 208, 240		1350	223 lbs.	10747

** Add 1⅜" to depth for drawer handle. Height does not include standard 4" plastic legs.

All Freestanding Drawer Warmer Models Feature:

Plug: NEMA 5-15P (208 and 240V use NEMA 6-15P).

Models Shipped with: One 6" deep food pan per drawer, 4" plastic legs, 6' cord and plug.
Cord Location: Back of unit, lower left corner.

SPLIT DRAWER WARMERS

Model	Dimensions** W x D x H	Voltage		Watts	Approx. Ship Weight	List Price
		Single Phase	Three Phase			
HDW-1R2	28⅞" x 16⅝" x 10⅞"	120		690	90 lbs.	\$ 6545
HDW-1.5R2	28⅞" x 16½" x 15½"	120		990	112 lbs.	9293
HDW-2R2	28⅞" x 16⅝" x 20"	120		1290	135 lbs.	10202

** Add 1⅜" to depth for drawer handle. Height does not include standard 4" plastic legs.

All Split Drawer Warmer Models Feature:

Plug: NEMA 5-15P.

HDW-1R2 shipped with: Two 2½" deep food pans, 4" legs, 6' cord and plug.

HDW-1.5R2 shipped with: Three 2½" deep food pans, 4" legs, 6' cord and plug.

HDW-2R2 shipped with: Four 2½" deep food pans, 4" legs, 6' cord and plug.

Pan Capacity: 20¼"W x 12¼"D x 2½"H.

Cord Location: Back of unit, lower left corner.

Quick-Ship Program Information Inside Back Cover

BUILT-IN DRAWER WARMERS

Model	Dimensions** W x D x H	Voltage		Watts	Approx. Ship Weight	List Price
		Single Phase	Three Phase			
HDW-1B	28¼" x 22⅝" x 9⅞"	120, 208, 240		450	88 lbs.	\$ 4314
✓ HDW-2B	28¼" x 22⅝" x 20"	120, 208, 240		900	159 lbs.	7291
HDW-3B	28¼" x 22⅝" x 30⅞"	120, 208, 240		1350	232 lbs.	10266
HDW-1BN	19½" x 26¾" x 9⅞"	120, 208, 240		450	88 lbs.	4314
HDW-2BN	19½" x 26¾" x 20"	120, 208, 240		900	159 lbs.	7291
HDW-3BN	19½" x 26¾" x 30⅞"	120, 208, 240		1350	232 lbs.	10266

** Add 1⅜" to depth for drawer handle. Width and Height excludes front mounting flange.

All Built-In Drawer Warmer Models Feature:

Conduit: 4" flexible conduit.

Models Shipped with: One 6" deep food pan per drawer.

OPTIONS AND ACCESSORIES – PAGE 154

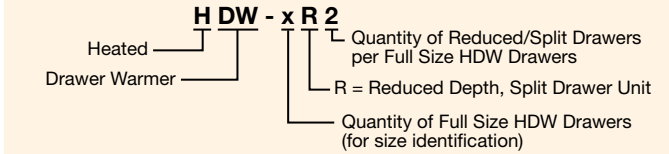
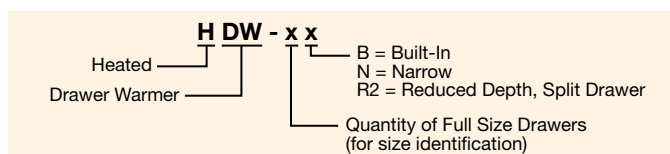



OPTIONS (available at time of purchase only)

Designer Drawer Front colors per drawer (not available for HDW-1R2, -1.5R2, -2R2 models)

Non-standard colors are non-returnable – Stainless steel standard

RED	Warm Red	\$118
BLACK	Black	118
GRAY	Gray Granite	118
WHITE	White Granite	118
NAVY	Navy Blue	118
GREEN	Hunter Green	118
COPPER	Antique Copper	118
HDW-TTC	Temperature Control Timer – 6-channel control touchscreen display	\$1054
OS-PAN	Oversized Drawer Frame and Pan (20" x 15" x 5") in lieu of Standard Drawer with Pan, standard width models only (excludes HDW-1R2, -1.5R2, -2R2)	per drawer 240
BIS DRAWER	Biscuit Pan Drawer – accommodates two 18" x 13" Half-Size Sheet Pans (not included) in lieu of standard Drawer with Pan, standard width models only (excludes HDW-1R2, -1.5R2, -2R2)	No Charge
HDW-CHIP	Chip Guard (excludes HDW-1R2, -1.5R2, -2R2)	per drawer 79
RD-NOVENT	No Drawer Vents (HDW-1R2, -1.5R2, -2R2 only)	No Charge

ACCESSORIES (available for purchase at any time)

HDW-TRIVET	Custom trivet raises food product 1/2" off bottom of full size pan 17 1/2" x 9 1/2" x 1/2"	\$103
HDW 6" LEG	6" Adjustable Stainless Steel Legs, standard on HDW-4 (excludes HDW-1R2, -1.5R2, -2R2)	328
HDW-CASTER-2	2" Dia. Casters – all swivel, 2 lock – adds 2 1/4" to height of unit, HDW-1, -2, -3 models only (excludes HDW-1R2, -1.5R2, -2R2)	401
HDW-CASTER-3	3" Dia. Locking Casters – all swivel, all lock – adds 4 1/4" to height of unit, HDW-1, -2, -3 models only (excludes HDW-1R2, -1.5R2, -2R2)	401
HDW-CASTER-5	5" Dia. Locking Casters – all swivel, all lock – adds 6 1/4" to height of unit (excludes HDW-1R2, -1.5R2, -2R2)	481
HDW-SPILL	Water/Spillage Pan – one per drawer (excludes HDW-1R2, -1.5R2, -2R2 and BIS Drawer, and OS-Pan Options)	456
HDW-SPLASH	Splash Baffle – one per drawer (excludes HDW-1R2, -1.5R2, -2R2 and BIS Drawer, and OS-Pan Options)	96

FOOD PANS AND TRIVETS – PAGE 240

COLORS AND FINISHES – PAGE 241

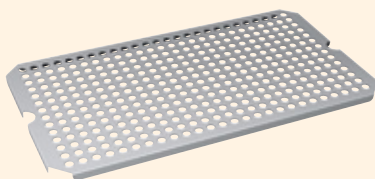

HDW-TRIVET



CASTERS

- HDW-CASTER-2** all swivel, 2 lock
- HDW-CASTER-3** all swivel, all lock
- HDW-CASTER-5** all swivel, all lock



HDW 6" LEG

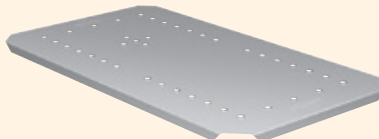

HDW-SPLASH

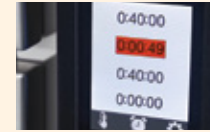

HDW-TTC Option

Shown: Temperature adjustment and timer touchscreen control



Biscuit Pan Drawer (pans not included) **BIS DRAWER** option

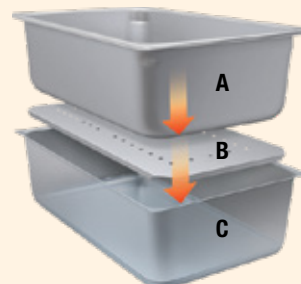

Additional Humidity

- A. Stainless Steel Food Pan
- B. Splash Baffle **HDW-SPLASH** accessory
- C. Water/Spillage Pan (add 1/4" of water) **HDW-SPILL** accessory

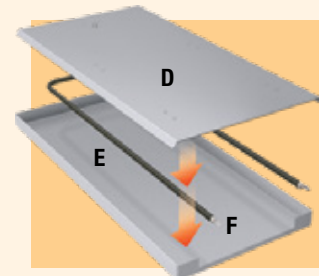

Prevents chips from reaching the element

- D. Heat Shield (included)
- E. Heating Element (included)
- F. Chip Guard **HDW-CHIP** option (Standard width shown)



Convected Drawer Warmer

This drawer warmer is designed to keep a variety of food products hot and flavor-fresh until served. With a single non-humidified cavity and a single electronic temperature control, this unit provides even, dry heat for food products that do not require humidity. With insulated top, sides and back, they provide excellent energy efficiency.

- Digital electronic controller for easy programming
- Low velocity convected air system provides even temperature throughout the cabinet
- Tough, durable chrome handles that are angled to avoid contact from passing carts
- Narrow width fits most kitchen footprints
- Heavy-duty drawer slides with nylon rollers
- Includes three full-size pans
- Provides even, dry heat for food products that do not require humidity.



CDW-3N

CONVECTED DRAWER WARMER

Model	Dimensions [↔] W x D x H	Voltage Single Phase	Watts	Approx. Ship Weight	List Price
CDW-3N	16 ⁵ / ₈ " x 28 ³ / ₃₂ " x 27 ¹ / ₂ "	120	1015	179 lbs.	\$8809

↔ Add 1³/₈" to depth for drawer handle. Height does not include casters, which add 2¹/₂" to height.

All Convected Drawer Warmer Models Feature:

Plug: NEMA 5-15P.

Models Shipped with: One 6" deep food pan per drawer, low profile 2" diameter casters, 6' cord and plug.

Cord Location: Back of unit, top right corner.

FOOD PANS AND TRIVETS – PAGE 240

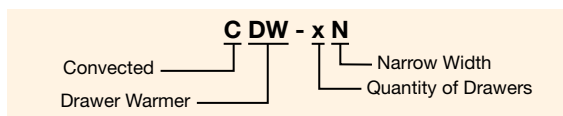



Heated Rice Drawer Warmers

Hatco's Heated Rice Drawer Warmers are designed to keep rice hot and at desired consistency until served. It holds rice in the same pot it's prepared in, reducing pan-to-pan transfer time and labor. With a digital electronic temperature control, this unit provides even heat throughout the holding cavity. With all around insulation, these drawer warmers provide excellent energy efficiency.

- Drawers accept Panasonic 23 cup rice pots (pots and lids not available)
- Drawers accept Town 30 cup rice pots with accessory Town 30 cup pot drawer adapters (pots and lids not available)
- Allows one pot per drawer of cooked rice for long term holding, with the option of serving from third pot in top heated well (HRDW-2U-1 only)

- Stainless steel construction, including back panel, handles the rigors of daily kitchen use
- Heavy-duty drawers and robust telescopic drawer slides makes pan removal easy and efficient
- Stainless steel utensil well and utensil pan included with HRDW-2U and HRDW-2U-1 models only
- Adjustable t-stat with knob for optimal rice holding in top well (HRDW-2U-1 only)
- Raised beveled edge on top of HRDW-2, HRDW-2U models only

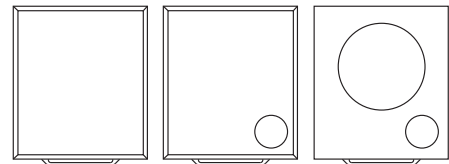

HRDW-2

HRDW-2U

HRDW-2U-1

HRDW-2U-1 with accessory hinged lid and standard utensil well and utensil pan

HEATED RICE DRAWER WARMERS

Model	Dimensions** W x D x H	Voltage Single Phase	Watts	Amps	Approx. Ship Weight	List Price
HRDW-2	20¼" x 22 ¹³ / ₁₆ " x 35 ¹ / ₈ "	120	700	5.8	153 lbs.	\$8466
HRDW-2U	20¼" x 22 ¹³ / ₁₆ " x 35 ¹ / ₈ "	120	700	5.8	150 lbs.	8817
HRDW-2U-1	20¼" x 22 ¹³ / ₁₆ " x 35 ¹ / ₈ "	120	1150	9.6	150 lbs.	9884

* Add 1³/₈" to depth for drawer handle. Height does not include casters - add 5" to height for standard 4" casters.

All Heated Rice Drawer Warmer Models Feature:

Plug: NEMA 5-15P.

Models Shipped with: Utensil pan (HRDW-2U and HRDW-2U-1 only), 4" casters, 6' cord and plug.

Cord Location: Back of unit, upper left corner.

ACCESSORIES (available for purchase at any time)

HRDW-LID	Hinged aluminum lid for top rice well (HRDW-2U-1 only)	\$384
HRDW-TOWN30	One Drawer Adapter for Town 30 cup rice pots (one per drawer required)	227



HRDW-LID

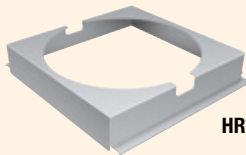

HRDW-TOWN30

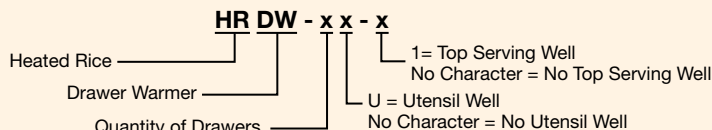

Merchandisers & Display Cases





Flav-R-Savor® Refrigerated Air Curtain Merchandisers

The Hatco Flav-R-Savor® Air Curtain Merchandiser is the ultimate solution for showcasing fresh, cold products while driving impulse sales. Designed for high-end merchandising, this sleek countertop unit offers easy accessibility and optimal temperature control. With even air distribution and superior product visibility, it not only preserves product freshness but also enhances the appeal of packaged foods and cold beverages — perfect for boosting profits and elevating foodservice offerings.

- Product temperature range between 31°F to 41°F (-1°C to 5°C)
- Simple, intuitive digital controls
- 3500K LED lights on the top, front and sides create balanced lighting that highlights food products and beverages
- Includes one adjustable, removable 13" (330 mm) deep shelf
- Doorless design allows for immediate access to products, prevents the spread of germs, and eliminates the need to wipe down handles and doors
- Swing-out, left-hinged rear door allows for loading the unit without blocking customer access
- Sleek black textured exterior with insulated glass end panels
- Uses eco-friendly R-290 refrigerant
- Comes standard with a night shade to conserve energy when unit is not in use and a magnetically attached sign holder [Sign dimensions: 23.875" W x 3.5" H x .25" D (606 x 89 x 6 mm)]
- Equipped with 4" (102 mm) legs and a 6' (1829 mm) cord

Merchandisers & Display Cases



FS3RAC-2726
In Designer Black with sign holder (Sign not included)



FS3RAC-2726
In Designer Black with night shade

FLAV-R-SAVOR REFRIGERATED AIR CURTAIN MERCHANDISERS

Model	Dimensions (W x D x H) height includes legs	Chamber Height	Voltage	Watts	Amps	Plugs	List Price
FS3RAC-2726	26 ⁵ / ₈ " x 26 ³ / ₄ " x 38 ¹ / ₈ "	16 ¹ / ₂₅ "	115	9.8	6.0	NEMA 5-15P	\$26433

All Heated Air Curtain Merchandisers Models Feature:

Models Shipped with: One, swing-out left hinged rear door, one removeable shelf with sign holder in front, crumb tray, 4" legs and a 6' cord and plug.
Cord Location: Servers side, bottom left.

OPTIONS (available at time of purchase only)

Designer Color – Non-standard colors are non-returnable – Designer Black standard
Gray Gray Granite No Charge

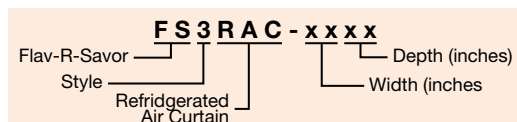



Flav-R-Savor® Heated Air Curtain Merchandisers

The newest models of our patented Flav-R-Savor® Heated Air Curtain Merchandisers has no front door, allowing customers easy access to fresh hot products. Heated air at the front of the cabinet is forced downward, forming a "curtain" of heated air. The heated air is then drawn toward the rear of the cabinet, warming each shelf gently and evenly.

- Perfect for wrapped or unwrapped food product.
- Consistent even temperatures result in longer quality hold times compared to traditional merchandisers
- The air temperature range is 70° - 175°F
- Easy to use digital controls
- Standard Designer Powercoat Black finish inside and outside for an uniform and sleek look to compliment any décor
- LED lighting on top front and sides, to create balanced lighting which showcases food product
- Removable shelves can be installed to be slanted or horizontal, with removable sign holders on each
- Front crumb tray lifts and pivots, and removable glass sides make for easy upkeep



FS3HAC-2426 with optional square side cut-outs and top sign holder (signs not included)



FS3HAC-3626 shelf signs not included



FS3HAC-4226 with optional tiered shelves

Merchandisers &
Display Cases

HEATED AIR CURTAIN MERCHANDISERS

Model	Dimensions (W x D x H) height includes legs	Shelf Dimensions W x D	Voltage	Watts	Amps	Plugs	Approx. Ship Weight	List Price
FS3HAC-2426	24" x 27 ³ / ₈ " x 38"	20 ¹ / ₈ " x 17"	120	1800	15.0	NEMA 5-20P	183 lbs.	\$16033
FS3HAC-3026	30" x 27 ³ / ₈ " x 38"	26 ¹ / ₈ " x 17"	120/208-240	3340	13.8	NEMA 14-20P	211 lbs.	17461
FS3HAC-3626	36" x 27 ³ / ₈ " x 38"	32 ¹ / ₈ " x 17"	120/208-240	3340	13.8	NEMA 14-20P	227 lbs.	18806
FS3HAC-4226	42" x 27 ³ / ₈ " x 38"	38" x 17"	120/208-240	3430	14.3	NEMA 14-20P	274 lbs.	20153

All Heated Air Curtain Merchandiser Models Feature:

Models Shipped with: **FS3HAC-2426, -3026:** One, swing-out left hinged rear door, three removeable shelves with sign holder in front, crumb tray, 4" legs and a 6' cord and plug.
FS3HAC-3626, -4226: Sliding glass rear door, three removeable shelves with sign holder in front, crumb tray, 4" legs and a 6' cord and plug.

Cord Location: Servers side, bottom left.

OPTIONS AND ACCESSORIES – PAGE 160

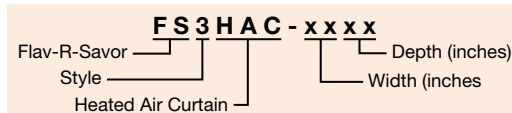



FS3HAC-2426 with optional square side cut-outs and top sign holder (signs not included)

OPTIONS (available at time of purchase only)

SIDECONTROL	Right- or Left-Hand Side Controls - must specify side at time of order	No Charge
RTHGDOOR	Right Hinged Access Door in lieu of Left Hinged Access Door (FS3HAC-2426, -3026 models only)	No Charge
TIERSHELVES	Tiered shelves in lieu of standard depth shelves	No Charge
PRODSTOP-STDSH	Side product stops for standard depth shelves	\$200
PRODSTOP-TIERSH	Side product stops for tiered shelves	22
SQSIDEPANEL	Square side cut-outs in lieu of curved side cut-outs	No Charge
SIGN24	Sign Holder for the FS3HAC-2426. Sign dimensions: 23 ⁷ / ₈ " x 6 ³ / ₄ "	73
SIGN30	Sign Holder for the FS3HAC-3026. Sign dimensions: 29 ⁷ / ₈ " x 6 ³ / ₄ "	76
SIGN36	Sign Holder for the FS3HAC-3626. Sign dimensions: 35 ⁷ / ₈ " x 6 ³ / ₄ "	79
SIGN42	Sign Holder for the FS3HAC-4226. Sign dimensions: 41 ⁷ / ₈ " x 6 ³ / ₄ "	81
LOCKPLUG	NEMA L14-20P Locking plug in lieu of NEMA 14-20P (FS3HAC-3026, -3626, -4226 units only)	281
Side Stops/Divider Rails – Kits for order at time of purchase only –		
RAIL-STD24	15 rails for 24 standard model (5 per shelf)	\$ 698
RAIL-STD30	18 rails for 30 standard model (6 per shelf)	837
RAIL-STD36	21 rails for 36 standard model (7 per shelf)	977
RAIL-STD42	24 rails for 42 standard model (8 per shelf)	1116
RAIL-TR24	15 rails for 24 tiered model (5 per shelf)	665
RAIL-TR30	18 rails for 30 tiered model (6 per shelf)	800
RAIL-TR36	21 rails for 36 tiered model (7 per shelf)	935
RAIL-TR42	24 rails for 42 tiered model (8 per shelf)	1070

ACCESSORIES (available for purchase at any time)

Side Stops/Divider Rails – sold individually –

RAIL-TOPT-BLACK	Top tiered shelf in <i>Designer Black</i>	each \$43
RAIL-MIDT-BLACK	Middle tiered shelf in <i>Designer Black</i>	each 44
RAIL-STD-BLACK	Standard shelf and tiered bottom shelf in <i>Designer Black</i>	each 45



RAIL-MIDT-BLACK Use as side stops or divider rails



Glo-Ray® Pizza Warmers

Convenient for self-serve and quick-serve areas. The Hatco Glo-Ray® Pizza Warmers with base heat only hold boxed or bagged pizzas. Available in one, two, three or four shelf configuration, perfect for high volume applications.

- Box stop doubles as the sign holder (signs not included), a standard feature (excluding base only unit)
- Constructed of aluminum and stainless steel with tempered glass side panels (excluding base only unit)
- Separate power switch for each thermostatically-controlled shelf
- Dual and Triple Shelf units have LED lights, Quadruple Shelf units have incandescent lights



GRPWS-2424
with base heat only



GRPWS-2418D
(signs not included)



GRPWS-2424T
with optional
Designer Black



GRPWS-2418Q
(signs not included)

Merchandisers &
Display Cases

SLANT DISPLAY WARMERS WITH BASE HEAT ONLY

Model	No. of Bulbs, Divider Rods	Dimensions (W x D x H) <i>Height includes legs</i>	Voltage Single Phase	Usable Heated Shelf Space (W x D)	Watts	Plug	Approx. Ship Weight	List Price
Base Only								
GRPWS-2424 ‡	0,5	23 ⁷ / ₈ " x 25" x 7 ⁷ / ₈ "	120	22 ¹ / ₂ " x 21"	345	NEMA 5-15P	40 lbs.	\$3501
GRPWS-3624 ‡	0,7	35 ¹ / ₈ " x 25" x 7 ⁷ / ₈ "	120	34 ¹ / ₂ " x 21"	505	NEMA 5-15P	45 lbs.	3861
GRPWS-4824	0,9	47 ¹ / ₈ " x 25" x 10 ⁷ / ₈ "	120	46 ¹ / ₂ " x 21"	660	NEMA 5-15P	60 lbs.	4322
Dual Shelf								
GRPWS-2418D	4,0	23 ⁷ / ₈ " x 20 ¹ / ₈ " x 22 ⁵ / ₈ "	120	22 ¹ / ₂ " x 17 ³ / ₄ "	960	NEMA 5-15P	76 lbs.	\$6993
GRPWS-3618D	6,0	35 ⁷ / ₈ " x 20 ¹ / ₈ " x 22 ⁵ / ₈ "	120	34 ¹ / ₂ " x 17 ³ / ₄ "	1440	NEMA 5-15P	91 lbs.	7901
GRPWS-4818D ✎	8,0	47 ⁷ / ₈ " x 20 ¹ / ₈ " x 22 ⁵ / ₈ "	120	46 ¹ / ₂ " x 17 ³ / ₄ "	1920	NEMA 5-20P	136 lbs.	8771
GRPWS-2424D	4,0	23 ⁷ / ₈ " x 26 ¹ / ₈ " x 23 ³ / ₈ "	120	22 ¹ / ₂ " x 23 ³ / ₄ "	1200	NEMA 5-15P	108 lbs.	7573
GRPWS-3624D	6,0	35 ⁷ / ₈ " x 26 ¹ / ₈ " x 23 ³ / ₈ "	120	34 ¹ / ₂ " x 23 ³ / ₄ "	1800	NEMA 5-20P	136 lbs.	8609
GRPWS-4824D	8,0	47 ⁷ / ₈ " x 26 ¹ / ₈ " x 23 ³ / ₈ "	120/208-240	46 ¹ / ₂ " x 23 ³ / ₄ "	2390	NEMA L14-20P	177 lbs.	9631
Triple Shelf								
GRPWS-2418T	6,0	23 ⁷ / ₈ " x 20 ¹ / ₈ " x 29 ³ / ₄ "	120	22 ¹ / ₂ " x 17 ³ / ₄ "	1440	NEMA 5-15P	98 lbs.	\$ 9001
GRPWS-3618T	9,0	35 ⁷ / ₈ " x 20 ¹ / ₈ " x 29 ³ / ₄ "	120/208-240	34 ¹ / ₂ " x 17 ³ / ₄ "	2160	NEMA L14-20P	136 lbs.	10318
GRPWS-4818T	12,0	47 ⁷ / ₈ " x 20 ¹ / ₈ " x 29 ³ / ₄ "	120/208-240	46 ¹ / ₂ " x 17 ³ / ₄ "	2880	NEMA L14-20P	175 lbs.	11913
GRPWS-2424T	6,0	23 ⁷ / ₈ " x 26 ¹ / ₈ " x 30 ³ / ₄ "	120	22 ¹ / ₂ " x 23 ³ / ₄ "	1800	NEMA 5-20P	116 lbs.	9847
GRPWS-3624T	9,0	35 ⁷ / ₈ " x 26 ¹ / ₈ " x 30 ³ / ₄ "	120/208-240	34 ¹ / ₂ " x 23 ³ / ₄ "	2700	NEMA L14-20P	167 lbs.	11679
GRPWS-4824T	12,0	47 ⁷ / ₈ " x 26 ¹ / ₈ " x 30 ³ / ₄ "	120/208-240	46 ¹ / ₂ " x 23 ³ / ₄ "	3585	NEMA L14-20P	227 lbs.	13176
Quadruple Shelf								
GRPWS-2418Q	8,0	23 ⁷ / ₈ " x 20 ¹ / ₈ " x 36 ⁷ / ₈ "	120/208-240	22 ¹ / ₂ " x 17 ³ / ₄ "	1920	NEMA L14-20P	119 lbs.	\$11098
GRPWS-3618Q	12,0	35 ⁷ / ₈ " x 20 ¹ / ₈ " x 36 ⁷ / ₈ "	120/208-240	34 ¹ / ₂ " x 17 ³ / ₄ "	2880	NEMA L14-20P	157 lbs.	13168
GRPWS-4818Q	16,0	47 ⁷ / ₈ " x 20 ¹ / ₈ " x 36 ⁷ / ₈ "	120/208-240	46 ¹ / ₂ " x 17 ³ / ₄ "	3840	NEMA L14-20P	214 lbs.	14937
GRPWS-2424Q	8,0	23 ⁷ / ₈ " x 26 ¹ / ₈ " x 37 ⁷ / ₈ "	120/208-240	22 ¹ / ₂ " x 23 ³ / ₄ "	2400	NEMA L14-20P	151 lbs.	12180
GRPWS-3624Q	12,0	35 ⁷ / ₈ " x 26 ¹ / ₈ " x 37 ⁷ / ₈ "	120/208-240	34 ¹ / ₂ " x 23 ³ / ₄ "	3600	NEMA L14-20P	214 lbs.	14503
GRPWS-4824Q	16,0	47 ⁷ / ₈ " x 26 ¹ / ₈ " x 37 ⁷ / ₈ "	120/208-240	46 ¹ / ₂ " x 23 ³ / ₄ "	4780	NEMA L14-30P	277 lbs.	16836

‡ Height includes 1" legs. Other models ship with 4" legs.

✎ Also available in 120/208-240V.

All Slant Models Feature:

Cord Location: Server side, bottom right corner

OPTIONS AND ACCESSORIES – PAGE 162

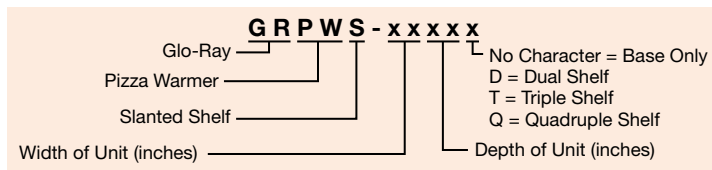



GRPWS-4818T (signs not included)

OPTIONS (available at time of purchase only)

Designer Colors – Non-standard colors are non-returnable – Stainless Steel standard –

RED	Warm Red	\$748
BLACK	Black	748
GRAY	Gray Granite	748
WHITE	White Granite	748
NAVY	Navy Blue	748
GREEN	Hunter Green	748
COPPER	Antique Copper	748
HAL	60 Watt Halogen Bulb in lieu of Standard Display Light	each \$102

LED Lights in lieu of Standard Display Lights – Dual and Triple Shelf models only –

LED-WW-24	Warm White LED lighting for 24 width models	No Charge
LED-WW-36	Warm White LED lighting for 36 width models	No Charge
LED-WW-48	Warm White LED lighting for 48 width models	No Charge

ACCESSORIES (available for purchase at any time)

Chef LED 120V adjustable bulb – bulbs must be rotated down –

CLED-3000-120	Similar to warm Halogen light	
CLED-4000-120	Similar to cool Fluorescent light	each \$205

COLORS AND FINISHES – PAGE 241

RECOMMENDED SIGN DIMENSIONS

- Excluding base only units -

GRPWS-24's: 22¼" x 2¾" x 1/8"

GRPWS-36's: 34¼" x 2¾" x 1/8"

GRPWS-48's: 46¼" x 2¾" x 1/8"

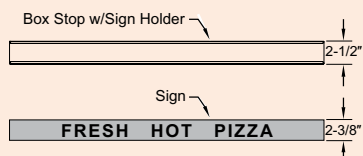



Glo-Ray® Merchandising Warmers

Designed with both a slanted and horizontal shelf, Glo-Ray® Merchandising Warmers offer the convenience of customer self-serve with the efficiency of preparing and holding product in advance for peak serving periods.

- Warmer includes a slant and horizontal shelf for merchandising a variety of products
- Standard Indicating Temperature Control (ITC) enhances accuracy and provides digital readout of temperatures
- Thermostatically-controlled hardcoated heated base to extend holding times
- Pre-focused infrared top heat directs heat to the outer edges where heat loss is greatest
- Product divider rods and 4" legs included
- Shatter-resistant incandescent lights illuminate the holding areas and emphasize the product
- Low watt models feature low watt overhead heat on the top shelf to hold popcorn. For fried food holding - select high watt models
- High watt models feature high watt overhead heat on top shelf to hold fried foods. For popcorn holding - select the lower watt models



GRSDS/H-36D with lower slant and upper horizontal shelf. Shown with optional 15" clearance - standard clearance is 12".



GRSDS/H-36DHW with lower slant and upper horizontal shelf. Shown with standard clearance of 12".

Merchandisers & Display Cases

SLANT/HORIZONTAL DISPLAY WARMERS – DUAL SHELVES

Model	No. of Bulbs, Divider Rods	Dimensions W x D x H	Voltage Single Phase	Watts	Plug	Approx. Ship Weight	List Price
Low Watt - Top shelf overhead heat is designed to hold popcorn.							
GRSDS/H-30D	4, 12	30" x 24¼" x 33½"	120	1530	NEMA 5-20P	140 lbs.	\$11225
GRSDS/H-36D	4, 14	36" x 24¼" x 33½"	120	1810	NEMA 5-20P	158 lbs.	11844
GRSDS/H-41D	6, 16	41" x 24¼" x 33½"	120/208-240	2120	NEMA L14-20P	178 lbs.	12678
High Watt - Top shelf overhead heat is designed to hold fries and sandwiches.							
GRSDS/H-30DHW [▲]	4, 12	30" x 24¼" x 33½"	120/208-240	2450	NEMA L14-20P	140 lbs.	\$11718
GRSDS/H-36DHW [▲]	4, 14	36" x 24¼" x 33½"	120/208-240	2910	NEMA L14-20P	158 lbs.	12339
GRSDS/H-41DHW [▲]	6, 16	41" x 24¼" x 33½"	120/208-240	3360	NEMA L14-20P	178 lbs.	13171

▲ High wattage on top shelf only.

All Slant/Horizontal Display Warmer Models Feature:

Cord Location – Back Counter Display Models: Server side, bottom right corner.

OPTIONS (available at time of purchase only)

Designer Colors – Non-standard colors are non-returnable

– Glossy Gray standard –

RED	Warm Red	\$748
BLACK	Black	748
GRAY	Gray Granite	748
WHITE	White Granite	748
NAVY	Navy Blue	748
GREEN	Hunter Green	748
COPPER	Antique Copper	748
15SPACE	15" clearance top shelf in lieu of standard 12" clearance (add 3" to height of unit)	\$218
HAL	60 Watt Halogen Bulb in lieu of Standard Display Light	each 102

ACCESSORIES (available for purchase at any time)

GRSDS-DIV	Additional Stainless Steel Divider Rods (Bottom shelf only)	each \$44
GRSDH-DIV	Additional Stainless Steel Divider Rods (Top shelf only)	each 44

COLORS AND FINISHES – PAGE 241

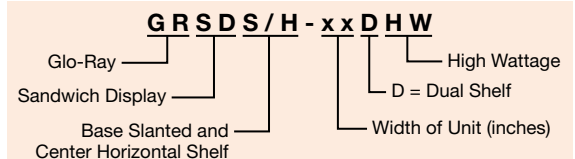



Glo-Ray® Merchandising Warmers

Designed specifically for showcasing wrapped or boxed product, the Hatco Glo-Ray® Merchandising Warmers hold hot food safely at proper serving temperatures. These warmers offer the convenience of self-serve and the efficiency of kitchen-to-server holding.

- Available in single- or two-tier models (slant models available in three-tier)
- Product divider rods sort food displays
- Thermostatically-controlled hardcoated heated base, with a temperature range of 185°- 200°F, to extend holding times
- Horizontal or slant shelves

- Pre-focused infrared top heat directs heat to the outer edges where heat loss is greatest
- Shatter-resistant incandescent lights illuminate the holding areas and emphasize the product



GRSDS-30 with accessory 4" legs



GRSDH-30D



GRSDS-36T with optional Designer Black

Quick-Ship Program Information Inside Back Cover

Merchandisers & Display Cases

HORIZONTAL MERCHANDISING WARMERS

Model	No. of Bulbs, Divider Rods	Dimensions (W x D x H) Height includes legs	Voltage	Usable Heated Shelf Space (W x D)	Watts	Plug	Approx. Ship Weight	List Price
Single Shelf								
GRSDH-24	2, 5	24" x 19½" x 12"	120	22¾" x 16½"	830	NEMA 5-15P	48 lbs.	\$5003
GRSDH-30	2, 6	30" x 19½" x 12"	120	28¾" x 16½"	970	NEMA 5-15P	56 lbs.	5455
GRSDH-36	2, 7	36" x 19½" x 12"	120	34¾" x 16½"	1170	NEMA 5-15P	66 lbs.	5909
GRSDH-41	3, 8	41" x 19½" x 15"	120	39¾" x 16½"	1340	NEMA 5-15P	74 lbs.	6435
GRSDH-52	4, 10	52" x 19½" x 15"	120	50¾" x 16½"	1760	NEMA 5-20P	86 lbs.	7512
GRSDH-60	5, 12	60" x 19½" x 15"	120/208-240	58¾" x 16½"	2100	NEMA L14-20P	133 lbs.	8463
Dual Shelf								
GRSDH-24D	4, 10	24" x 19½" x 25⅝"	120	22¾" x 16½"	1660	NEMA 5-20P	88 lbs.	\$ 8774
GRSDH-30D♣	4, 12	30" x 19½" x 28⅝"	120	28¾" x 16½"	1920	NEMA 5-20P	100 lbs.	9101
GRSDH-36D	4, 14	36" x 19½" x 25⅝"	120/208-240	34¾" x 16½"	2340	NEMA L14-20P	120 lbs.	9635
GRSDH-41D	6, 16	41" x 19½" x 25⅝"	120/208-240	39¾" x 16½"	2680	NEMA L14-20P	137 lbs.	10238
GRSDH-52D	8, 20	52" x 19½" x 25⅝"	120/208-240	50¾" x 16½"	3520	NEMA L14-20P	172 lbs.	11795
GRSDH-60D♣	10, 24	60" x 19½" x 28⅝"	120/208-240	58¾" x 16½"	4200	NEMA L14-30P	197 lbs.	13001

SLANT MERCHANDISING WARMERS

Model	No. of Bulbs, Divider Rods	Dimensions (W x D x H) Height includes legs	Voltage	Usable Heated Shelf Space (W x D)	Watts	Plug	Approx. Ship Weight	List Price
Single Shelf								
✓ GRSDS-24	2, 5	24" x 24¼" x 18½"	120	22½" x 21"	695	NEMA 5-15P	79 lbs.	\$6018
GRSDS-30	2, 6	30" x 24¼" x 18½"	120	28½" x 21"	790	NEMA 5-15P	80 lbs.	6452
GRSDS-36	2, 7	36" x 24¼" x 21½"	120	34½" x 21"	935	NEMA 5-15P	92 lbs.	6950
GRSDS-41	3, 8	41" x 24¼" x 21½"	120	39½" x 21"	1090	NEMA 5-15P	96 lbs.	7459
GRSDS-52	4, 10	52" x 24¼" x 21½"	120	50½" x 21"	1400	NEMA 5-15P	110 lbs.	8559
GRSDS-60	5, 12	60" x 24¼" x 21½"	120	58½" x 21"	1715	NEMA 5-20P	167 lbs.	9247
Dual Shelf								
GRSDS-24D	4, 10	24" x 24¼" x 32⅝"	120	22½" x 21"	1355	NEMA 5-15P	115 lbs.	\$ 9406
✓ GRSDS-30D	4, 12	30" x 24¼" x 32⅝"	120	28½" x 21"	1530	NEMA 5-20P	140 lbs.	9981
✓ GRSDS-36D	4, 14	36" x 24¼" x 32⅝"	120	34½" x 21"	1810	NEMA 5-20P	160 lbs.	10632
GRSDS-41D	6, 16	41" x 24¼" x 32⅝"	120/208-240	39½" x 21"	2120	NEMA L14-20P	180 lbs.	11433
GRSDS-52D	8, 20	52" x 24¼" x 32⅝"	120/208-240	50½" x 21"	2725	NEMA L14-20P	215 lbs.	13280
GRSDS-60D	10, 24	60" x 24¼" x 32⅝"	120/208-240	58½" x 21"	3340	NEMA L14-20P	238 lbs.	14106
Triple Shelf								
GRSDS-36T	6, 21	35⅝" x 24¼" x 43⅞"	120/208-240	34½" x 21"	2685	NEMA L14-20P	219 lbs.	\$13028

♣ Includes external fuse box on top of unit.
 ♣ Requires 2, 120V power cords.

All Merchandising Warmer Models Feature:
 Cord Location: **Horizontal Models:** Left rear corner toward server side.
Slant Models: Server side, bottom right corner.

OPTIONS AND ACCESSORIES – PAGE 165

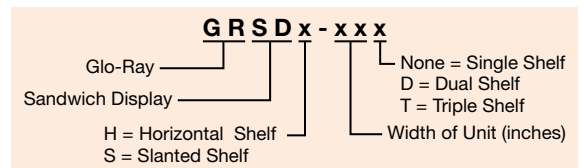



Two GRSDH-36D with dual horizontal shelves

Merchandisers & Display Cases

OPTIONS (available at time of purchase only)

ITC-S	Indicating Temperature Control (LED) for single shelf	\$545
ITC-D	Indicating Temperature Control (LED) for dual shelf	941
SSEND	Stainless Steel End Panels in lieu of Glass End Panels	per shelf 76
5" Sneeze Guard (GRSDS one side, GRSDH two sides) –		
GRSD24BP	24" wide models	per shelf \$248
GRSD30BP	30" wide models	per shelf 296
GRSD36BP	36" wide models	per shelf 346
GRSD41BP	41" wide models	per shelf 397
GRSD52BP	52" wide models	per shelf 452
GRSD60BP	60" wide models	per shelf 638
HAL	60 Watt Halogen Bulb in lieu of Standard Display Light	each \$102
GRSDFLILOCK1	Flip-Up Door Locking Plate (for GRSDS, GRSDS-xxD, and GRSDS-xxT 24" to 41" wide models)	per shelf 33
GRSDFLILOCK2	Flip-up Door Locking Plates (for GRSDS and GRSDS-xxD 52" to 60" wide models)	per shelf 74

Display Sign Holder (Signs not included) – Color Matches Unit Color – Top or Intermediate Shelf (Slant or Horizontal models) –

GRSD-24SIGN	24" width. Requires 22 $\frac{5}{8}$ "W x 3 $\frac{7}{8}$ "H x $\frac{1}{16}$ "D sign	each \$227
GRSD-30SIGN	30" width. Requires 28 $\frac{5}{8}$ "W x 3 $\frac{7}{8}$ "H x $\frac{1}{16}$ "D sign	each 237
GRSD-36SIGN	36" width. Requires 34 $\frac{5}{8}$ "W x 3 $\frac{7}{8}$ "H x $\frac{1}{16}$ "D sign	each 247
GRSD-41SIGN	41" width. Requires 39 $\frac{5}{8}$ "W x 3 $\frac{7}{8}$ "H x $\frac{1}{16}$ "D sign	each 258
GRSD-52SIGN	52" width. Requires 50 $\frac{5}{8}$ "W x 3 $\frac{7}{8}$ "H x $\frac{1}{16}$ "D sign	each 278
GRSD-60SIGN	60" width. Requires 58 $\frac{5}{8}$ "W x 3 $\frac{7}{8}$ "H x $\frac{1}{16}$ "D sign	each 303

Plexi-Glass Flip-Up Doors on one side for GRSDS models – Not compatible with optional Sneeze Guards or Display Sign Holders in same opening –

SDS24FLIP	24" wide models	per shelf \$453
SDS30FLIP	30" wide models	per shelf 453
SDS36FLIP	36" wide models	per shelf 453
SDS41FLIP	41" wide models	per shelf 453
SDS52FLIP	52" wide models	per shelf 771
SDS60FLIP	60" wide models	per shelf 771

Plexi-Glass Flip-Up Doors on one side for GRSDH models – Not compatible with optional Sneeze Guards or Display Sign Holders in same opening –

GRSDH24FLIP	24" wide models	per shelf \$453
GRSDH30FLIP	30" wide models	per shelf 453
GRSDH36FLIP	36" wide models	per shelf 453
GRSDH41FLIP	41" wide models	per shelf 453
GRSDH52FLIP	52" wide models	per shelf 771
GRSDH60FLIP	60" wide models	per shelf 771

ACCESSORIES (available for purchase at any time)

4"LEGS	4" Adjustable Legs (standard on units GRSDH-41 and larger, GRSDS-36 and larger and all duals)	Set of 4 \$ 98
Chef LED 120V adjustable bulb – bulbs must be rotated down –		
	CLED-3000-120 Similar to warm Halogen light	
	CLED-4000-120 Similar to cool Fluorescent light	each 205
GRSDH-DIV	Additional Stainless Steel Divider Rods – Horizontal model	each \$44
GRSDS-DIV	Additional Stainless Steel Divider Rods – Slant model	each 44

OPTIONS (available at time of purchase only)

Designer Colors – Non-standard colors are non-returnable – Glossy Gray standard –

RED	Warm Red	\$748
BLACK	Black	748
GRAY	Gray Granite	748
WHITE	White Granite	748
NAVY	Navy Blue	748
GREEN	Hunter Green	748
COPPER	Antique Copper	748

COLORS AND FINISHES – PAGE 241

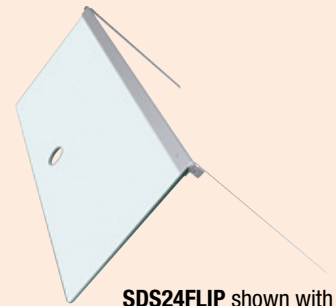

SDS24FLIP shown with brackets for retrofit



CLED-3000 and -4000 Accessory



Glo-Ray® Designer Merchandising Warmers

Boost impulse sales by showcasing your hot foods in the Hatco Glo-Ray® Designer Merchandising Warmers. Designed specifically for displaying wrapped or boxed product, these warmers hold hot food safely at proper serving temperatures.

- Constructed of aluminum and stainless steel with tempered glass side panels
- Pre-focused infrared top heat directs heat to the outer edges where heat loss is greatest
- Convenient for self-serve or quick-serve areas
- Available in single- or two-tier models
- Horizontal or slant shelves
- Thermostatically-controlled hardcoated heated base extends holding times

- Product divider rods sort food displays
- Shatter-resistant incandescent lights illuminate the holding areas and emphasize the product



GR2SDH-30 with standard Designer Black inset panels and accessory flip-up plexi-glass door

NOTE: Designer Series width dimensions are 6¼" greater than the number listed in model.

Quick-Ship Program Information Inside Back Cover

DESIGNER HORIZONTAL DISPLAY WARMERS

Model [Ⓢ]	No. of Bulbs, Divider Rods	Dimensions W x D x H (Height includes legs)	Voltage	Usable Heated Shelf Space (W x D)	Watts	Plug	Approx. Ship Weight	List Price
Single Shelf								
GR2SDH-24	2, 5	30¼" x 27" x 18½"	120	23⅞" x 22"	820	NEMA 5-15P	87 lbs.	\$6645
GR2SDH-30	2, 6	36¼" x 27" x 18½"	120	29⅞" x 22"	1020	NEMA 5-15P	120 lbs.	7154
GR2SDH-36	2, 7	42¼" x 27" x 18½"	120	35⅞" x 22"	1220	NEMA 5-15P	129 lbs.	7676
GR2SDH-42	4, 8	48¼" x 27" x 18½"	120	41⅞" x 22"	1490	NEMA 5-20P	138 lbs.	8514
GR2SDH-48	4, 9	54¼" x 27" x 18½"	120	47⅞" x 22"	1690	NEMA 5-20P	160 lbs.	9357
GR2SDH-54	4, 10	60¼" x 27" x 18½"	120	53⅞" x 22"	1890	NEMA 5-20P	172 lbs.	10216
GR2SDH-60	6, 12	66¼" x 27" x 18½"	120	59⅞" x 22"	2210	NEMA 5-30P	200 lbs.	11003
Dual Shelf								
GR2SDH-24D	4, 10	30¼" x 27" x 29"	120	23⅞" x 22"	1640	NEMA 5-20P	125 lbs.	\$10996
GR2SDH-30D	4, 12	36¼" x 27" x 29"	120/208-240	29⅞" x 22"	2040	NEMA L14-20P	158 lbs.	11634
GR2SDH-36D	4, 14	42¼" x 27" x 29"	120/208-240	35⅞" x 22"	2440	NEMA L14-20P	205 lbs.	12234
GR2SDH-42D	8, 16	48¼" x 27" x 29"	120/208-240	41⅞" x 22"	2980	NEMA L14-20P	225 lbs.	13397
GR2SDH-48D	8, 18	54¼" x 27" x 29"	120/208-240	47⅞" x 22"	3380	NEMA L14-20P	254 lbs.	14544
GR2SDH-54D	8, 20	60¼" x 27" x 29"	120/208-240	53⅞" x 22"	3780	NEMA L14-20P	274 lbs.	15727
GR2SDH-60D	12, 24	66¼" x 27" x 29"	120/208-240	59⅞" x 22"	4420	NEMA L14-30P	328 lbs.	16848

DESIGNER SLANT DISPLAY WARMERS

Model [Ⓢ]	No. of Bulbs, Divider Rods	Dimensions W x D x H (Height includes legs)	Voltage	Usable Heated Shelf Space (W x D)	Watts	Plug	Approx. Ship Weight	List Price
Single Shelf								
GR2SDS-24	2, 5	30¼" x 26¾" x 22⅞"	120	23⅞" x 22"	820	NEMA 5-15P	102 lbs.	\$ 7178
GR2SDS-30	2, 6	36¼" x 26¾" x 22⅞"	120	29⅞" x 22"	1020	NEMA 5-15P	110 lbs.	7576
GR2SDS-36	2, 7	42¼" x 26¾" x 22⅞"	120	35⅞" x 22"	1220	NEMA 5-15P	136 lbs.	8241
GR2SDS-42	4, 8	48¼" x 26¾" x 22⅞"	120	41⅞" x 22"	1490	NEMA 5-20P	155 lbs.	9076
GR2SDS-48	4, 9	54¼" x 26¾" x 22⅞"	120	47⅞" x 22"	1690	NEMA 5-20P	164 lbs.	9897
GR2SDS-54	4, 10	60¼" x 26¾" x 22⅞"	120	53⅞" x 22"	1890	NEMA 5-20P	182 lbs.	10736
GR2SDS-60	6, 12	66¼" x 26¾" x 22⅞"	120	59⅞" x 22"	2210	NEMA 5-30P	202 lbs.	11503
Dual Shelf								
✓ GR2SDS-24D	4, 10	30¼" x 26¾" x 33⅞"	120	23⅞" x 22"	1640	NEMA 5-20P	160 lbs.	\$11194
✓ GR2SDS-30D	4, 12	36¼" x 26¾" x 33⅞"	120/208-240	29⅞" x 22"	2040	NEMA L14-20P	184 lbs.	11983
✓ GR2SDS-36D	4, 14	42¼" x 26¾" x 33⅞"	120/208-240	35⅞" x 22"	2440	NEMA L14-20P	200 lbs.	12740
GR2SDS-42D	8, 16	48¼" x 26¾" x 33⅞"	120/208-240	41⅞" x 22"	2980	NEMA L14-20P	218 lbs.	13924
GR2SDS-48D	8, 18	54¼" x 26¾" x 33⅞"	120/208-240	47⅞" x 22"	3380	NEMA L14-20P	255 lbs.	15067
GR2SDS-54D	8, 20	60¼" x 26¾" x 33⅞"	120/208-240	53⅞" x 22"	3780	NEMA L14-20P	265 lbs.	16244
GR2SDS-60D	12, 24	66¼" x 26¾" x 33⅞"	120/208-240	59⅞" x 22"	4420	NEMA L14-30P	296 lbs.	17365

Ⓢ When no color is specified, color inset panels and corner caps will be Black.

All Designer Display Warmer Models Feature:
Cord Location: Server side, bottom center.

OPTIONS AND ACCESSORIES – PAGE 167

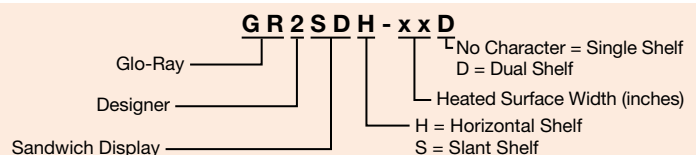



GR2SDS-24D with optional Designer color inset panels

FSDT-1 with accessory food pans

Merchandisers & Display Cases

OPTIONS (available at time of purchase only)

Designer Corner Caps – Black standard –		
DKGRAY	Dark Gray Corner Caps	No Charge
5" Sneeze Guard – Customer side only on Slant models –		
GR2SD24BP	30 1/4" wide models	per shelf \$201
GR2SD30BP	36 1/4" wide models	per shelf 252
GR2SD36BP	42 1/4" wide models	per shelf 302
GR2SD42BP	48 1/4" wide models	per shelf 353
GR2SD48BP	54 1/4" wide models	per shelf 402
GR2SD54BP	60 1/4" wide models	per shelf 453
GR2SD60BP	66 1/4" wide models	per shelf 503
Plexi-Glass Flip-up Doors – on Control or Customer Side –		
2SDS24FLIP	30 1/8" wide models	per shelf \$337
2SDS30FLIP	36 1/8" wide models	per shelf 386
2SDS36FLIP	42 1/8" wide models	per shelf 439
2SDS42FLIP	48 1/8" wide models	per shelf 499
2SDS48FLIP	54 1/8" wide models - split doors	per shelf 584
2SDS54FLIP	60 1/8" wide models - split doors	per shelf 679
2SDS60FLIP	66 1/8" wide models - split doors	per shelf 780
2SDHRTGLS	Front Glass in lieu of Channel Dividers and Divider Rods. Cannot have Sneeze Guards or Flip-Up Doors (GR2SDH series, single models only)	\$183
2SDHRTGLS-D	Front Glass in lieu of Channel Dividers and Divider Rods. Cannot have Sneeze Guards or Flip-Up Doors (GR2SDH series, dual models only)	368
HAL	60 Watt Halogen Bulb in lieu of Standard Display Light	each 102
SS-ITC	Indicating Temperature Control (LED) for single shelf (adds 1 1/8" to Horizontal model depth and 1 3/4" to Slant model depth)	545
DS-ITC	Indicating Temperature Control (LED) for dual shelf (adds 1 1/8" to Horizontal model depth and 1 3/4" to Slant model depth)	941

ACCESSORIES (available for purchase at any time)

2SD-DIV	Additional Stainless Steel Divider Rods	each \$ 44
Chef LED 120V adjustable bulb – bulbs must be rotated down –		
	CLED-3000-120 Similar to warm Halogen light	
	CLED-4000-120 Similar to cool Fluorescent light	each 205

COLORS AND FINISHES – PAGE 241

CLED-3000 and -4000 Accessory



OPTIONS

(available at time of purchase only)

Designer Colors –		
Non-standard colors are non-returnable		
– Clear Anodized Aluminum standard –		
RED	Warm Red	\$748
BLACK	Black	748
GRAY	Gray Granite	748
WHITE	White Granite	748
NAVY	Navy Blue	748
GREEN	Hunter Green	748
COPPER	Antique Copper	748

Designer Inset Panel Colors –		
Non-standard colors are non-returnable		
– Black standard –		
RED	Warm Red	No Charge
GRAY	Gray Granite	No Charge
WHITE	White Granite	No Charge
NAVY	Navy Blue	No Charge
GREEN	Hunter Green	No Charge
COPPER	Antique Copper	No Charge



SS-ITC Optional



DS-ITC Optional



Heated LED Merchandisers

The Heated Merchandiser with LED lighting is sleekly designed to safely hold hot packaged food to attract your grab-and-go customers. Available in slant or horizontal shelves, the Heated LED Merchandising Warmers are offered in both single and dual shelf models.

- Choose from slant or horizontal, single or dual shelf models
- Infrared heat safely holds hot packaged product for hours
- High efficiency LED lighting creates better illumination of food product in the holding area
- Feature a thermostatically-controlled hardcoated heated base shelf
- Hinged glass side panels are held in place magnetically and swing out for easy cleaning

- An optional Indicating Temperature Control (ITC) enhances accurate control of temperature



HXMS-36D
in standard
Designer Black

Merchandisers & Display Cases

HORIZONTAL HEATED LED MERCHANDISING WARMERS

Model	Divider Rods	Dimensions (W x D x H) <i>Height includes legs</i>	Heated Shelf Space (W x D)	Voltage	Watts	Amps	Plugs	Approx. Ship Weight	List Price
Horizontal Single Shelf									
HXMH-24	5	28" x 28 $\frac{1}{8}$ " x 21 $\frac{1}{8}$ "	22 $\frac{3}{8}$ " x 21 $\frac{3}{4}$ "	120	700	5.8	NEMA 5-15P	120 lbs.	\$ 7434
HXMH-30	6	34" x 28 $\frac{1}{8}$ " x 21 $\frac{1}{8}$ "	28 $\frac{3}{8}$ " x 21 $\frac{3}{4}$ "	120	900	7.5	NEMA 5-15P	133 lbs.	7975
HXMH-36	7	40" x 28 $\frac{1}{8}$ " x 21 $\frac{1}{8}$ "	34 $\frac{3}{8}$ " x 21 $\frac{3}{4}$ "	120	1100	9.2	NEMA 5-15P	145 lbs.	8514
HXMH-42	8	46" x 28 $\frac{1}{8}$ " x 21 $\frac{1}{8}$ "	40 $\frac{3}{8}$ " x 21 $\frac{3}{4}$ "	120	1200	10.0	NEMA 5-15P	161 lbs.	9397
HXMH-48	9	52" x 28 $\frac{1}{8}$ " x 21 $\frac{1}{8}$ "	46 $\frac{3}{8}$ " x 21 $\frac{3}{4}$ "	120	1450	12.1	NEMA 5-20P	190 lbs.	10282
HXMH-54	10	58" x 28 $\frac{1}{8}$ " x 21 $\frac{1}{8}$ "	52 $\frac{3}{8}$ " x 21 $\frac{3}{4}$ "	120	1650	13.8	NEMA 5-20P	200 lbs.	11165
HXMH-60	12	64" x 28 $\frac{1}{8}$ " x 21 $\frac{1}{8}$ "	58 $\frac{3}{8}$ " x 21 $\frac{3}{4}$ "	120	1850	15.4	NEMA 5-20P	206 lbs.	11977
Horizontal Dual Shelf									
HXMH-24D	10	28" x 28 $\frac{1}{8}$ " x 32 $\frac{3}{4}$ "	22 $\frac{3}{8}$ " x 21 $\frac{3}{4}$ "	120	1400	11.7	NEMA 5-15P	160 lbs.	\$12110
HXMH-30D	12	34" x 28 $\frac{1}{8}$ " x 32 $\frac{3}{4}$ "	28 $\frac{3}{8}$ " x 21 $\frac{3}{4}$ "	120/208-240	1800	7.5	NEMA L14-20P	185 lbs.	12949
HXMH-36D	14	40" x 28 $\frac{1}{8}$ " x 32 $\frac{3}{4}$ "	34 $\frac{3}{8}$ " x 21 $\frac{3}{4}$ "	120/208-240	2200	9.2	NEMA L14-20P	205 lbs.	13544
HXMH-42D	16	46" x 28 $\frac{1}{8}$ " x 32 $\frac{3}{4}$ "	40 $\frac{3}{8}$ " x 21 $\frac{3}{4}$ "	120/208-240	2400	10.0	NEMA L14-20P	220 lbs.	14778
HXMH-48D	18	52" x 28 $\frac{1}{8}$ " x 32 $\frac{3}{4}$ "	46 $\frac{3}{8}$ " x 21 $\frac{3}{4}$ "	120/208-240	2900	12.1	NEMA L14-20P	244 lbs.	15977
HXMH-54D	20	58" x 28 $\frac{1}{8}$ " x 32 $\frac{3}{4}$ "	52 $\frac{3}{8}$ " x 21 $\frac{3}{4}$ "	120/208-240	3300	13.8	NEMA L14-20P	271 lbs.	17198
HXMH-60D	24	64" x 28 $\frac{1}{8}$ " x 32 $\frac{3}{4}$ "	58 $\frac{3}{8}$ " x 21 $\frac{3}{4}$ "	120/208-240	3700	15.4	NEMA L14-20P	300 lbs.	18326

SLANT HEATED LED MERCHANDISING WARMERS

Model	Divider Rods	Dimensions (W x D x H) <i>Height includes legs</i>	Heated Shelf Space (W x D)	Voltage	Watts	Amps	Plugs	Approx. Ship Weight	List Price
Slant Single Shelf									
HXMS-24	5	28" x 28 $\frac{1}{8}$ " x 21 $\frac{1}{4}$ "	22 $\frac{3}{8}$ " x 21 $\frac{3}{4}$ "	120	700	5.8	NEMA 5-15P	112 lbs.	\$ 7738
HXMS-30	6	34" x 28 $\frac{1}{8}$ " x 21 $\frac{1}{4}$ "	28 $\frac{3}{8}$ " x 21 $\frac{3}{4}$ "	120	900	7.5	NEMA 5-15P	133 lbs.	8167
HXMS-36	7	40" x 28 $\frac{1}{8}$ " x 21 $\frac{1}{4}$ "	34 $\frac{3}{8}$ " x 21 $\frac{3}{4}$ "	120	1100	9.2	NEMA 5-15P	150 lbs.	8884
HXMS-42	8	46" x 28 $\frac{1}{8}$ " x 21 $\frac{1}{4}$ "	40 $\frac{3}{8}$ " x 21 $\frac{3}{4}$ "	120	1200	10.0	NEMA 5-15P	161 lbs.	9775
HXMS-48	9	52" x 28 $\frac{1}{8}$ " x 21 $\frac{1}{4}$ "	46 $\frac{3}{8}$ " x 21 $\frac{3}{4}$ "	120	1450	12.1	NEMA 5-20P	188 lbs.	10665
HXMS-54	10	58" x 28 $\frac{1}{8}$ " x 21 $\frac{1}{4}$ "	52 $\frac{3}{8}$ " x 21 $\frac{3}{4}$ "	120	1650	13.8	NEMA 5-20P	205 lbs.	11569
HXMS-60	12	64" x 28 $\frac{1}{8}$ " x 21 $\frac{1}{4}$ "	58 $\frac{3}{8}$ " x 21 $\frac{3}{4}$ "	120	1850	15.4	NEMA 5-20P	205 lbs.	12399
Slant Dual Shelf									
HXMS-24D	10	28" x 28 $\frac{1}{8}$ " x 32 $\frac{3}{4}$ "	22 $\frac{3}{8}$ " x 21 $\frac{3}{4}$ "	120	1400	11.7	NEMA 5-15P	160 lbs.	\$12110
HXMS-30D	12	34" x 28 $\frac{1}{8}$ " x 32 $\frac{3}{4}$ "	28 $\frac{3}{8}$ " x 21 $\frac{3}{4}$ "	120/208-240	1800	7.5	NEMA L14-20P	187 lbs.	12949
HXMS-36D	14	40" x 28 $\frac{1}{8}$ " x 32 $\frac{3}{4}$ "	34 $\frac{3}{8}$ " x 21 $\frac{3}{4}$ "	120/208-240	2200	9.2	NEMA L14-20P	208 lbs.	13726
HXMS-42D	16	46" x 28 $\frac{1}{8}$ " x 32 $\frac{3}{4}$ "	40 $\frac{3}{8}$ " x 21 $\frac{3}{4}$ "	120/208-240	2400	10.0	NEMA L14-20P	232 lbs.	14994
HXMS-48D	18	52" x 28 $\frac{1}{8}$ " x 32 $\frac{3}{4}$ "	46 $\frac{3}{8}$ " x 21 $\frac{3}{4}$ "	120/208-240	2900	12.1	NEMA L14-20P	245 lbs.	16241
HXMS-54D	20	58" x 28 $\frac{1}{8}$ " x 32 $\frac{3}{4}$ "	52 $\frac{3}{8}$ " x 21 $\frac{3}{4}$ "	120/208-240	3300	13.8	NEMA L14-20P	270 lbs.	17506
HXMS-60D	24	64" x 28 $\frac{1}{8}$ " x 32 $\frac{3}{4}$ "	58 $\frac{3}{8}$ " x 21 $\frac{3}{4}$ "	120/208-240	3700	15.4	NEMA L14-20P	291 lbs.	18709

All Heated LED Merchandising Warmer Models Feature:
Cord Location: Server side, bottom center on left side of control box.

OPTIONS AND ACCESSORIES – PAGE 170

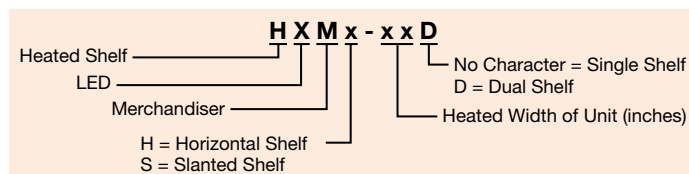



Heated Zone Merchandisers

The energy-efficient Hatco Heated Zone Merchandiser safely holds hot packaged food in eye catching design to draw in your customers, while LED lighting showcases your food product. Hatco's Spot-On® Technology will reduce your energy consumption while keeping your foods at the desired temperature.

- Spot-On technology turns overhead heat on only when product is present in that zone, while base heat goes from energy saving mode to the temperature you set
- Our fast action ribbon elements will be up to temperature in less than 10 seconds
- Choose from slant or horizontal shelves, single or dual shelf models, and in 2 to 12 zones depending on the model size
- LCD display scans and displays the various zone settings

- Hinged glass side panels swing out for easy cleaning
- Channel dividers are held in place by magnets, giving the unit more heated surface



HZMH-24 in standard Designer Black



Merchandisers & Display Cases

HORIZONTAL HEATED ZONE MERCHANDISING WARMERS

Model	Zones per Shelf	Divider Rods	Dimensions (W x D x H) <i>Height includes legs</i>	Usable Heated Surface per Zone (W x D)	Voltage Single Phase	Watts	Plug	Approx. Ship Weight	List Price
Horizontal Single Shelf									
HZMH-24	2	3	28" x 28 ⁵ / ₈ " x 21 ³ / ₄ "	20" x 21 ³ / ₄ "	120	750	NEMA 5-15P	125 lbs	\$ 9657
HZMH-30	4	4	34" x 28 ⁵ / ₈ " x 21 ³ / ₄ "	12 ³ / ₈ " x 21 ³ / ₄ "	120	1350	NEMA 5-15P	141 lbs	10339
HZMH-36	4	4	40" x 28 ⁵ / ₈ " x 21 ³ / ₄ "	15 ³ / ₈ " x 21 ³ / ₄ "	120	1400	NEMA 5-15P	159 lbs	11030
HZMH-42	4	6	46" x 28 ⁵ / ₈ " x 21 ³ / ₄ "	18 ³ / ₈ " x 21 ³ / ₄ "	120	1450	NEMA 5-20P	172 lbs	12156
HZMH-48	4	6	52" x 28 ⁵ / ₈ " x 21 ³ / ₄ "	21 ³ / ₈ " x 21 ³ / ₄ "	120	1500	NEMA 5-20P	182 lbs	13271
HZMH-54	6	6	58" x 28 ⁵ / ₈ " x 21 ³ / ₄ "	15 ¹ / ₁₆ " x 21 ³ / ₄ "	120	2100	NEMA 5-30P	202 lbs	14406
HZMH-60	6	9	64" x 28 ⁵ / ₈ " x 21 ³ / ₄ "	17 ¹ / ₁₆ " x 21 ³ / ₄ "	120	2150	NEMA 5-30P	216 lbs	15467
Horizontal Dual Shelf									
HZMH-24D	2	6	28" x 28 ⁵ / ₈ " x 32 ³ / ₄ "	20" x 21 ³ / ₄ "	120	1500	NEMA 5-20P	176 lbs	\$16041
HZMH-30D	4	8	34" x 28 ⁵ / ₈ " x 32 ³ / ₄ "	12 ³ / ₈ " x 21 ³ / ₄ "	120/208-240	2700	NEMA L14-20P	204 lbs	16884
HZMH-36D	4	8	40" x 28 ⁵ / ₈ " x 32 ³ / ₄ "	15 ³ / ₈ " x 21 ³ / ₄ "	120/208-240	2800	NEMA L14-20P	228 lbs	17665
HZMH-42D	4	12	46" x 28 ⁵ / ₈ " x 32 ³ / ₄ "	18 ³ / ₈ " x 21 ³ / ₄ "	120/208-240	2900	NEMA L14-20P	246 lbs	19846
HZMH-48D	4	12	52" x 28 ⁵ / ₈ " x 32 ³ / ₄ "	21 ³ / ₈ " x 21 ³ / ₄ "	120/208-240	3000	NEMA L14-20P	265 lbs	20785
HZMH-54D	6	12	58" x 28 ⁵ / ₈ " x 32 ³ / ₄ "	15 ¹ / ₁₆ " x 21 ³ / ₄ "	120/208-240	4200	NEMA L14-30P	308 lbs	22339
HZMH-60D	6	18	64" x 28 ⁵ / ₈ " x 32 ³ / ₄ "	17 ¹ / ₁₆ " x 21 ³ / ₄ "	120/208-240	4300	NEMA L14-30P	331 lbs	23843

SLANT HEATED ZONE MERCHANDISING WARMERS

Model	Zones per Shelf	Divider Rods	Dimensions (W x D x H) <i>Height includes legs</i>	Usable Heated Surface per Zone (W x D)	Voltage Single Phase	Watts	Plug	Approx. Ship Weight	List Price
Slant Single Shelf									
HZMS-24	2	3	28" x 28 ⁵ / ₈ " x 21 ³ / ₄ "	20" x 21 ³ / ₄ "	120	750	NEMA 5-15P	120 lbs	\$10461
HZMS-30	4	4	34" x 28 ⁵ / ₈ " x 21 ³ / ₄ "	12 ³ / ₈ " x 21 ³ / ₄ "	120	1350	NEMA 5-15P	145 lbs	10997
HZMS-36	4	4	40" x 28 ⁵ / ₈ " x 21 ³ / ₄ "	15 ³ / ₈ " x 21 ³ / ₄ "	120	1400	NEMA 5-15P	159 lbs	11894
HZMS-42	4	6	46" x 28 ⁵ / ₈ " x 21 ³ / ₄ "	18 ³ / ₈ " x 21 ³ / ₄ "	120	1450	NEMA 5-20P	172 lbs	13010
HZMS-48	4	6	52" x 28 ⁵ / ₈ " x 21 ³ / ₄ "	21 ³ / ₈ " x 21 ³ / ₄ "	120	1500	NEMA 5-20P	187 lbs	14109
HZMS-54	6	6	58" x 28 ⁵ / ₈ " x 21 ³ / ₄ "	15 ¹ / ₁₆ " x 21 ³ / ₄ "	120	2100	NEMA 5-30P	202 lbs	15240
HZMS-60	6	9	64" x 28 ⁵ / ₈ " x 21 ³ / ₄ "	17 ¹ / ₁₆ " x 21 ³ / ₄ "	120	2150	NEMA 5-30P	216 lbs	16267
Slant Dual Shelf									
HZMS-24D	2	6	28" x 28 ⁵ / ₈ " x 32 ³ / ₄ "	20" x 21 ³ / ₄ "	120	1500	NEMA 5-20P	176 lbs	\$16433
HZMS-30D	4	8	34" x 28 ⁵ / ₈ " x 32 ³ / ₄ "	12 ³ / ₈ " x 21 ³ / ₄ "	120/208-240	2700	NEMA L14-20P	209 lbs	17503
HZMS-36D	4	8	40" x 28 ⁵ / ₈ " x 32 ³ / ₄ "	15 ³ / ₈ " x 21 ³ / ₄ "	120/208-240	2800	NEMA L14-20P	223 lbs	18525
HZMS-42D	4	12	46" x 28 ⁵ / ₈ " x 32 ³ / ₄ "	18 ³ / ₈ " x 21 ³ / ₄ "	120/208-240	2900	NEMA L14-20P	248 lbs	20112
HZMS-48D	4	12	52" x 28 ⁵ / ₈ " x 32 ³ / ₄ "	21 ³ / ₈ " x 21 ³ / ₄ "	120/208-240	3000	NEMA L14-20P	263 lbs	21756
HZMS-54D	6	12	58" x 28 ⁵ / ₈ " x 32 ³ / ₄ "	15 ¹ / ₁₆ " x 21 ³ / ₄ "	120/208-240	4200	NEMA L14-30P	298 lbs	23238
HZMS-60D	6	18	64" x 28 ⁵ / ₈ " x 32 ³ / ₄ "	17 ¹ / ₁₆ " x 21 ³ / ₄ "	120/208-240	4300	NEMA L14-30P	332 lbs	24740

All Heated Zone Merchandising Warmer Models Feature:

Cord Location: Server side, bottom center on left side of control box.

OPTIONS AND ACCESSORIES – PAGE 170

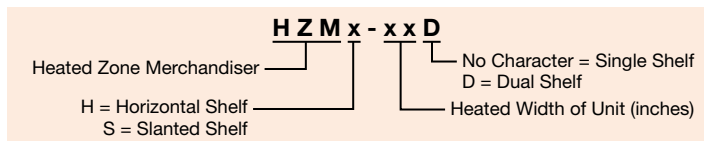



HZMS-48D in standard *Designer Black* with optional LED accent lighting in support posts

OPTIONS (available at time of purchase only)

Designer Colors – Non-standard colors are non-returnable – Black standard –

RED	Warm Red	\$748
GRAY	Gray Granite	748
WHITE	White Granite	748
NAVY	Navy Blue	748
GREEN	Hunter Green	748
COPPER	Antique Copper	748

HZM-LP	Red LED Accent Lighting in support post (HXM and HZM models)	\$1139
---------------	--	---------------

Wire Guards – Single shelf, Slant and Horizontal models – HZM models only –

HZMWG-24	Wire Guard on -24 models	\$139
HZMWG-30 -36 -42 -48	Wire Guard on -30, -36, -42 or -48 models	278
HZMWG-54 -60	Wire Guard on -54 or -60 models	417

Wire Guards – Dual shelf, Slant and Horizontal models – HZM models only –

HZMWG-24D	Wire Guard on -24D Models	\$278
HZMWG-30D -36D -42D -48D	Wire Guard on -30D, -36D, -42D or -48D Models	557
HZMWG-54D -60D	Wire Guard on -54D or -60D Models	835

SS-ITC	Indicating Temperature Control (LED) for single shelf (for HXM models only)	\$545
---------------	---	--------------

DS-ITC	Indicating Temperature Control (LED) for dual shelf (for HXM models only)	941
---------------	---	------------

Sneeze Guards – HXM and HZM models – Not compatible with Flip-Up Doors in same opening –

HZM24BP	5" Sneeze Guard on Customer Side on -24 models	per shelf \$419
HZM30BP	5" Sneeze Guard on Customer Side on -30 models	per shelf 456
HZM36BP	5" Sneeze Guard on Customer Side on -36 models	per shelf 493
HZM42BP	5" Sneeze Guard on Customer Side on -42 models	per shelf 543
HZM48BP	5" Sneeze Guard on Customer Side on -48 models	per shelf 592
HZM54BP	5" Sneeze Guard on Customer Side on -54 models	per shelf 645
HZM60BP	5" Sneeze Guard on Customer Side on -60 models	per shelf 697

Flip-Up Doors – HXM and HZM models – Not compatible with Sneeze Guards in same opening, one side only –

HZM24FLIP	Plexi-Glass Flip-up Doors on Control or Customer side on -24 models	per shelf \$420
HZM30FLIP	Plexi-Glass Flip-up Doors on Control or Customer side on -30 models	per shelf 456
HZM36FLIP	Plexi-Glass Flip-up Doors on Control or Customer side on -36 models	per shelf 497
HZM42FLIP	Plexi-Glass Flip-up Doors on Control or Customer side on -42 models	per shelf 541
HZM48FLIP	Plexi-Glass Flip-up Doors on Control or Customer side on -48 models	per shelf 588
HZM54FLIP	Plexi-Glass Flip-up Doors on Control or Customer side on -54 models	per shelf 645
HZM60FLIP	Plexi-Glass Flip-up Doors on Control or Customer side on -60 models	per shelf 702

ACCESSORIES (available for purchase at any time)

HZM-DIV	Additional Stainless Steel Divider Rods (HXM and HZM models)	each \$47
----------------	--	------------------

COLORS AND FINISHES – PAGE 241

Merchandisers & Display Cases



Glo-Ray® Heated Glass Merchandisers

Hatco's patented heated glass shelves provide maximum product visibility while increasing product capacity. All models are available in *Designer* colors or stainless steel, with tempered glass end panels, a thermostatically-controlled heated base, product divider rods and 2½" legs.

- The heated glass shelves make these self-serve merchandisers uniquely visual
- Patented heated glass shelf provides an even heat source for top and bottom heat to safely hold product
- Thermostatically-controlled, hardcoated heated base
- Standard 2½" adjustable legs (adds 2¾" to height of unit)
- Available in horizontal or slanted versions to meet your needs or style
- *Designer* color models, posts, base panels and sign holder for top and middle shelves optional. Non-standard colors are non-returnable
- Flip-up doors and 4" legs available
- LED lights showcase food product and saves energy and money
- Modular design accommodates side-by-side expansion



GR3SDH-39
in optional
Stainless Steel finish



GR3SDS-39D
in optional
Designer Navy Blue

Merchandisers &
Display Cases

HORIZONTAL DISPLAY WARMER WITH HEATED GLASS

Model	No. of Rods	Dimensions W x D x H †	Usable Heated Shelf Space (W x D)	Voltage	Watts	Plug	Approx. Ship Weight	List Price
Single Shelf								
GR3SDH-27	10	27¼" x 27¼" x 13¾"	22 ¹⁶ / ₂₅ " x 20 ¹⁶ / ₂₅ "	120	997	NEMA 5-15P	108 lbs.	\$7664
GR3SDH-33	12	33¼" x 27¼" x 13¾"	28 ¹⁶ / ₂₅ " x 20 ¹⁶ / ₂₅ "	120	1251	NEMA 5-15P	120 lbs.	8262
GR3SDH-39	14	39¼" x 27¼" x 13¾"	34 ¹⁶ / ₂₅ " x 20 ¹⁶ / ₂₅ "	120	1505	NEMA 5-20P	133 lbs.	8877
Dual Shelf								
GR3SDH-27D	15	27¼" x 27¼" x 23½"	22 ¹⁶ / ₂₅ " x 20 ¹⁶ / ₂₅ "	120	1769	NEMA 5-20P	147 lbs.	\$12711
GR3SDH-33D	18	33¼" x 27¼" x 23½"	28 ¹⁶ / ₂₅ " x 20 ¹⁶ / ₂₅ "	120/208-240	2227	NEMA L14-20P	166 lbs.	13431
GR3SDH-39D	21	39¼" x 27¼" x 23½"	34 ¹⁶ / ₂₅ " x 20 ¹⁶ / ₂₅ "	120/208-240	2685	NEMA L14-20P	194 lbs.	14116

SLANT DISPLAY WARMER WITH HEATED GLASS

Model	No. of Rods	Dimensions W x D x H †	Usable Heated Shelf Space (W x D)	Voltage	Watts	Plug	Approx. Ship Weight	List Price
Single Shelf								
GR3SDS-27	10	27¼" x 26 ⁷ / ₈ " x 18 ¹ / ₈ "	22 ¹⁶ / ₂₅ " x 20 ¹⁶ / ₂₅ "	120	997	NEMA 5-15P	115 lbs.	\$8277
GR3SDS-33	12	33¼" x 26 ⁷ / ₈ " x 18 ¹ / ₈ "	28 ¹⁶ / ₂₅ " x 20 ¹⁶ / ₂₅ "	120	1251	NEMA 5-15P	127 lbs.	8751
GR3SDS-39	14	39¼" x 26 ⁷ / ₈ " x 18 ¹ / ₈ "	34 ¹⁶ / ₂₅ " x 20 ¹⁶ / ₂₅ "	120	1505	NEMA 5-20P	156 lbs.	9512
Dual Shelf								
GR3SDS-27D	15	27¼" x 26 ⁷ / ₈ " x 28 ¹ / ₈ "	22 ¹⁶ / ₂₅ " x 20 ¹⁶ / ₂₅ "	120	1769	NEMA 5-20P	164 lbs.	\$12898
GR3SDS-33D	18	33¼" x 26 ⁷ / ₈ " x 28 ¹ / ₈ "	28 ¹⁶ / ₂₅ " x 20 ¹⁶ / ₂₅ "	120/208-240	2227	NEMA L14-20P	190 lbs.	13809
GR3SDS-39D	21	39¼" x 26 ⁷ / ₈ " x 28 ¹ / ₈ "	34 ¹⁶ / ₂₅ " x 20 ¹⁶ / ₂₅ "	120/208-240	2685	NEMA L14-20P	206 lbs.	14682

† Height does not include 2¾" legs.

All Heated Glass Display Warmer Models Feature:

Cord Location: Server side, bottom right corner.

OPTIONS AND ACCESSORIES – PAGE 172

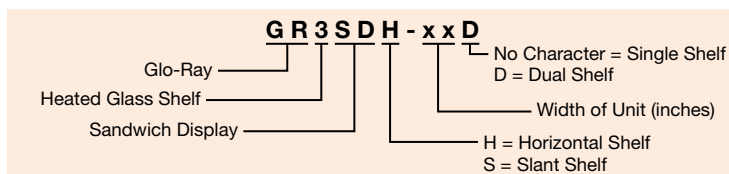



GR3SDS-39D in optional Designer Antique Copper

OPTIONS (available at time of purchase only)

Designer Colors – NNon-standard colors are non-returnable – Black standard –

RED	Warm Red	No Charge
GRAY	Gray Granite	No Charge
WHITE	White Granite	No Charge
NAVY	Navy Blue	No Charge
GREEN	Hunter Green	No Charge
COPPER	Antique Copper	No Charge
GR3-SS	Stainless Steel Body and Base (unpainted posts)	\$433
GR3SD27BP	5" Sneeze Guard on Customer side on 27¼" wide models	per shelf 354
GR3SD33BP	5" Sneeze Guard on Customer side on 33¼" wide models	per shelf 373
GR3SD39BP	5" Sneeze Guard on Customer side on 39¼" wide models	per shelf 397
3SD27FLIP	Plexi-Glass Flip-Up Doors on front or back on 27¼" wide models	per shelf 263
3SD33FLIP	Plexi-Glass Flip-Up Doors on front or back on 33¼" wide models	per shelf 322
3SD39FLIP	Plexi-Glass Flip-Up Doors on front or back on 39¼" wide models	per shelf 384
3SDEND	Plexi-Glass End Panels in lieu of Glass End Panels	per shelf 39

Painted Shelf Sign Holder (Signs not included) – Color matches unit color – Top or Intermediate Shelf – (Slant or Horizontal models) –

3SD27SIGN	27" width model. Requires 27"W x 2¼"H x ¼"D Sign	each \$158
3SD33SIGN	33" width model. Requires 33"W x 2¼"H x ¼"D Sign	each 171
3SD39SIGN	39" width model. Requires 39"W x 2¼"H x ¼"D Sign	each 182

ACCESSORIES (available for purchase at any time)

4" LEGS	4" Adjustable Legs	Set of 4 \$98
3SD-DIV	Additional Stainless Steel Divider Rods	each 44

COLORS AND FINISHES – PAGE 241



Glo-Ray® Heated Glass Merchandisers

Glo-Ray® Heated Glass Merchandising Warmers are perfect for self-serve operations, designed specifically to hold hot wrapped or boxed product at optimum serving temperatures. Increasing holding capacities and impulse sales with a beautiful curved design that compliments any décor.

- Unique, patented heated glass shelves with infinite controls conduct heat to food product above and below
- Blanket-style heating elements in the hardcoated base and canopy are thermostatically-controlled
- LED lighting allows for optimum food product display with energy saving

- Attractive curved top design includes a built-in top sign holder for your own custom signage, 26.75" W (679 mm) x 3" H (76 mm), at the top front of the unit
- Also comes with: tempered glass side panels, 2.5" legs, thermostatically-controlled heated base and upper canopy, divider rods and comes standard in *Designer Black*



GR3SDS-27TCT in optional *Designer Glossy Gray* and top sign holder (Sign not included)



GR3SDS-39DCT in standard *Designer Black* and top sign holder

Merchandisers & Display Cases

SLANT DISPLAY WARMERS WITH HEATED GLASS

Model	No. of Rods	Dimensions W x D x H †	Usable Heated Shelf Space (W x D)	Voltage	Watts	Plug	Approx. Ship Weight	List Price
Dual Shelf								
GR3SDS-27DCT	10	27 ¹ / ₄ " x 27 ⁷ / ₈ " x 26 ³ / ₈ "	22 ¹ / ₂₅ " x 20 ¹ / ₂₅ "	120	1340	NEMA 5-15P	155 lbs.	\$11982
GR3SDS-33DCT	12	33 ¹ / ₄ " x 27 ⁷ / ₈ " x 26 ³ / ₈ "	28 ¹ / ₂₅ " x 20 ¹ / ₂₅ "	120	1747	NEMA 5-20P	175 lbs.	13437
GR3SDS-39DCT	14	39 ¹ / ₄ " x 27 ¹ / ₂ " x 26 ¹ / ₂ "	34 ¹ / ₂₅ " x 20 ¹ / ₂₅ "	120/208-240	2130	NEMA L14-20P	186 lbs.	15833
Triple Shelf								
GR3SDS-27TCT	15	27 ¹ / ₄ " x 29" x 34 ³ / ₈ "	22 ¹ / ₂₅ " x 20 ¹ / ₂₅ "	120/208-240	2095	NEMA L14-20P	190 lbs.	\$15417
GR3SDS-33TCT	18	33 ¹ / ₄ " x 28" x 34 ³ / ₈ "	28 ¹ / ₂₅ " x 20 ¹ / ₂₅ "	120/208-240	2723	NEMA L14-20P	215 lbs.	17858
GR3SDS-39TCT	21	39 ¹ / ₄ " x 27 ¹ / ₂ " x 34 ³ / ₄ "	34 ¹ / ₂₅ " x 20 ¹ / ₂₅ "	120/208-240	3310	NEMA L14-20P	230 lbs.	19809

† Height includes 2.5" legs.

All Heated Glass Merchandiser Models Feature:
Cord Location: Server side, bottom right corner.

OPTIONS (available at time of purchase only)

Designer Colors – Non-standard colors are non-returnable – Black standard –		
RED	Warm Red	\$748
GRAY	Gray Granite	748
WHITE	White Granite	748
NAVY	Navy Blue	748
GREEN	Hunter Green	748
COPPER	Antique Copper	748
Gloss Finish – Non-standard colors are non-returnable – Black standard –		
GGRAY	Glossy Gray	\$748

ACCESSORIES (available for purchase at any time)

4" LEGS	4" Adjustable Legs	Set of 4 \$98
3SD-DIV	Additional Stainless Steel Divider Rods	each 44

COLORS AND FINISHES – PAGE 241

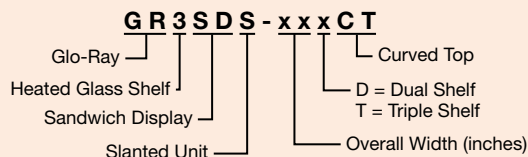



Glo-Ray® Designer Heated Display Cases

Our Designer series Glo-Ray® Heated Display Case with curved glass and incandescent lighting will display your offering with flare and elegance. We combine our thermostatically-controlled heated base and infrared overhead heating to blanket your offering at the perfect temperature.

- The tempered curved glass design offers a great line of sight to draw in your customers
- Hatco - exclusive cool base construction minimizes heat transfer, keeping the exterior base cool
- Rollerless sliding doors
- Available with or without controlled humidity (bottom shelf only)
- Constructed of aluminum and stainless steel with tempered glass
- Curved glass front tilts forward for easy cleaning

- Pre-focused infrared top heat directs heat to the outer edges where heat loss is greatest
- Shatter-resistant incandescent lights illuminate the food product



Humidified reservoir is located in between pans

Merchandisers & Display Cases



GRCD-2P with pan rail and optional Designer color, backlit sign holder (sign not included) and accessory food pans



GRCD-2PD with optional pan skirt, Designer Hunter Green and flip-up doors, and accessory food pans



GRCDH-1PD with pan skirt and new optional flip-up doors and accessory food pans. (top baking dish not available)



GRCDH-3PD shown in standard Stainless Steel with accessory food pans

DESIGNER DISPLAY CASES

Model	No. of Bulbs	Dimensions (W x D x H) <i>Height includes legs</i>	Voltage Single Phase	Watts	Plug	Approx. Ship Weight	List Price
Single Shelf							
GRCD-1P	2	20 ⁵ / ₈ " x 26" x 24"	120	410	NEMA 5-15P	95 lbs.	\$ 8320
GRCD-2P	3	32 ¹ / ₂ " x 26" x 24"	120	780	NEMA 5-15P	120 lbs.	9507
GRCD-3P	3	45 ¹ / ₂ " x 26" x 24"	120	1005	NEMA 5-15P	152 lbs.	10700
Dual Shelf							
GRCD-1PD	4	20 ⁵ / ₈ " x 26" x 31 ³ / ₄ "	120	860	NEMA 5-15P	98 lbs.	\$ 9725
GRCD-2PD	6	32 ¹ / ₂ " x 26" x 31 ³ / ₄ "	120	1210	NEMA 5-15P	170 lbs.	11083
GRCD-3PD	6	45 ¹ / ₂ " x 26" x 31 ³ / ₄ "	120	1710	NEMA 5-20P	210 lbs.	12778
Single Shelf with Humidity*							
GRCDH-1P	2	20 ⁵ / ₈ " x 26" x 24"	120	660	NEMA 5-15P	90 lbs.	\$ 9508
GRCDH-2P	3	32 ¹ / ₂ " x 26" x 24"	120	1030	NEMA 5-15P	124 lbs.	10702
GRCDH-3P	3	45 ¹ / ₂ " x 26" x 24"	120	1255	NEMA 5-20P	156 lbs.	11894
Dual Shelf with Humidity*							
GRCDH-1PD	4	20 ⁵ / ₈ " x 26" x 31 ³ / ₄ "	120	1110	NEMA 5-15P	120 lbs.	\$10915
GRCDH-2PD	6	32 ¹ / ₂ " x 26" x 31 ³ / ₄ "	120	1460	NEMA 5-20P	174 lbs.	12277
GRCDH-3PD Ⓞ	6	45 ¹ / ₂ " x 26" x 31 ³ / ₄ "	120	1960	NEMA 5-30P	220 lbs.	13971

* Humidity on bottom shelf only. Includes pan skirt on bottom shelf.
 Ⓞ Not available with Backlit Base Sign Holder.

All Designer Display Case Models Feature:
 Water Reservoir Capacity (Humidified models only): 3 quarts.
 Cord Location: Server side, bottom right corner.

OPTIONS – PAGE 175

WATER QUALITY REQUIREMENTS – PAGE 242

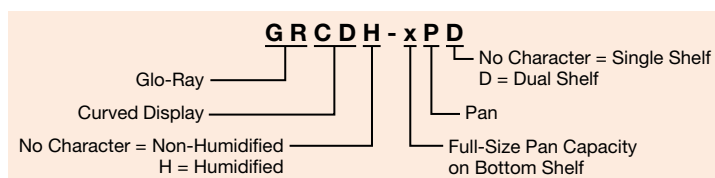

Usable Heated Shelf Space (W X D)

Model	Top Shelf	Bottom Shelf
GRCD-1P, GRCDH-1P	–	18 ¹ / ₈ " x 21"
GRCD-2P, GRCDH-2P	–	30" x 21"
GRCD-3P, GRCDH-3P	–	43" x 21"
GRCDH-1PD, GRCDH-1PD	18 ¹ / ₈ " x 15"	18 ¹ / ₈ " x 21"
GRCDH-2PD, GRCDH-2PD	30" x 15"	30" x 21"
GRCDH-3PD, GRCDH-3PD	43" x 15"	43" x 21"



GRCD-2PD with optional self-closing flip-up doors and Designer Warm Red

Merchandisers & Display Cases

OPTIONS (available at time of purchase only)

Backlit Base Sign Holder, 120V only (Sign not included) (Excluding GRCDH-3PD) –

BCKLIT SIGN 2-PAN	2-Pan Models (25 lbs.) Requires 32½"W x 5"H x ¼"D Translucent Sign	\$1135
BCKLIT SIGN 3-PAN	3-Pan Models (28 lbs.) Requires 45½"W x 5"H x ¼"D Translucent Sign	1260

Self-Closing Flip-Up Doors on both shelves on customer side in lieu of Glass Front (adds ½" depth to unit) –

CD1PDFLIP	1-Pan models	\$1314
CD2PDFLIP	2-Pan models	1406
CD3PDFLIP	3-Pan models	2482
HAL	60 Watt Halogen Bulb in lieu of Standard Display Light	each \$102

Pan Skirt on bottom shelf (accommodates 2½"D Pans – standard on humidified models) –

SKIRT-1P	1-Pan model in lieu of Pan Rail	\$ 91
SKIRT-2P	2-Pan model in lieu of Pan Rail	163
SKIRT-3P	3-Pan model in lieu of Pan Rail	233
UPPERSKIRT-2P	Pan Skirt for upper shelf of 2-Pan models	165
UPPERSKIRT-3P	Pan Skirt for upper shelf of 3-Pan models	333

Mirrored Glass Doors in lieu of Glass Doors (Server side only) –

Single Shelf Models –

MIRROR-1P	1-Pan single model	add \$142
MIRROR-2P	2-Pan single model	add 198
MIRROR-3P	3-Pan single model	add 255

Dual Shelf Models –

MIRROR-1PD	1-Pan dual model	add \$284
MIRROR-2PD	2-Pan dual model	add 397
MIRROR-3PD	3-Pan dual model	add 573

FOOD PANS AND TRIVETS – PAGE 240

OPTIONS (available at time of purchase only)

Designer Colors – Non-standard colors are non-returnable – Stainless Steel standard –

RED	Warm Red	\$748
BLACK	Black	748
GRAY	Gray Granite	748
WHITE	White Granite	748
NAVY	Navy Blue	748
GREEN	Hunter Green	748
COPPER	Antique Copper	748

COLORS AND FINISHES – PAGE 241

HEATED DISPLAY CASE MAXIMUM PAN CAPACITIES*

Model	Pan Capacity	Optional Pan Skirt Frames
GRCD-1P	1 Full-Size Pan	One SKIRT-1P
GRCD-2P	2 Full-Size Pans	One SKIRT-2P
GRCD-3P	3 Full-Size Pans	One SKIRT-3P
GRCD-1PD	Top Shelf 1 Half-Size Pan or 1-14" Pizza Pan	None
	Bottom Shelf 1 Full-Size Pan	One SKIRT-1P
GRCD-2PD	Top Shelf 1 Full-Size Pan and 1 Third-Size Pan or 2-14" Pizza Pans	One UPPERSKIRT-2P
	Bottom Shelf 2 Full-Size Pans	One SKIRT-2P
GRCD-3PD	Top Shelf 2 Full-Size Pans or 3-14" Pizza Pans	One UPPERSKIRT-3P
	Bottom Shelf 3 Full-Size Pans	One SKIRT-3P

* All pan capacities shown are for non-humidified models.
2½" deep pans recommended for bottom shelf of humidified models.



Flav-R-Savor® Convected Air, Curved Front Display Cases

This front-of-the-house curved glass merchandiser utilizes convected air technology for superior holding times. Maintaining peak serving temperatures for unwrapped foods makes this Hatco display case perfect for cafeteria and deli-style service.

- Perforated stainless steel shelf not only enhances air movement over food products, but looks great as well
- Focused lighting to enhance and merchandise your food products
- Easy to read, digitally-controlled temperature and humidity (FSCDH-2PD model only) display for precise control
- Standard sign holder promotes your product offering on bottom front of unit (sign not included). Recommended sign dimension: 33 1/8"W x 6"H
- Rear French doors for easy access
- Hinged, tempered front glass panel tilts forward for easy cleaning

- Optional glass shelf available
- Night Sky Simulated Stone panel on bottom shelf is standard, optional in Gray Granite or Bermuda Sand. Non-standard colors are non-returnable
- Models with Simulated Stone are Swanstone®



FSCDH-2PD in standard *Designer Black* with sign holder (sign not included), 3-sided skirt, perforated shelf and Night Sky Simulated Stone base. Also with accessory risers and food pans.

Merchandisers & Display Cases

CONVECTED AIR, CURVED FRONT DISPLAY CASES

Model	Dimensions W x D x H	Voltage single phase	Watts	Plug	Approx. Ship Weight	List Price
Non-Humidified						
FSCD-2PD	34 3/8" x 30 7/8" x 31 1/8"	120	1800	NEMA 5-20P	205 lbs.	\$13314
Humidified						
FSCDH-2PD	34 3/8" x 31 7/8" x 31 1/8"	120/208-240	2805	NEMA L14-20P	190 lbs.	\$14555

All Convected Air Display Case Models Feature:

Models Shipped With: Perforated upper shelf, heated Simulated stone base shelf, three-sided skirt and sign holder on bottom front. (sign not included) (recommended sign dimension: 33 1/8"W x 6"H).

Shelf Dimensions: **Upper:** 31 3/4"W x 16"D.
Lower: 32 1/4"W x 19 1/4"D.

Water Reservoir Capacity (Humidified model only): 7 quarts.

Cord Location: Server's side, back center of base, on right of control box.

WATER QUALITY REQUIREMENTS – PAGE 242

OPTIONS (available at time of purchase only)

Designer Colors – Non-standard colors are non-returnable – Black standard –

RED	Warm Red	No Charge
GRAY	Gray Granite	No Charge
WHITE	White Granite	No Charge
NAVY	Navy Blue	No Charge
GREEN	Hunter Green	No Charge
COPPER	Antique Copper	No Charge

Simulated Stone Colors – Non-standard colors are non-returnable – Night Sky standard –

SS-GGRAN	Gray Granite	No Charge
SS-BSAND	Bermuda Sand	No Charge

FSCDH-PLUMB	Valve Relocation allows draining from back of unit instead of directly under unit (Humidified model only)	\$344
FSCD-GLASS	Glass Center Shelf (in lieu of perforated metal shelf)	No Charge



1RISER10
Accessory

ACCESSORIES (available for purchase at any time)

1RISER10	10"D x 1 1/4"H Circular Perforated Riser in Stainless Steel	\$66
-----------------	---	-------------

* Our current Swanstone simulated stone options — Bermuda Sand, Gray Granite and Night Sky — will be discontinued at the end of 2025. We will introduce new Swanstone simulated stone options on January 1, 2026.

COLORS AND FINISHES – PAGE 241

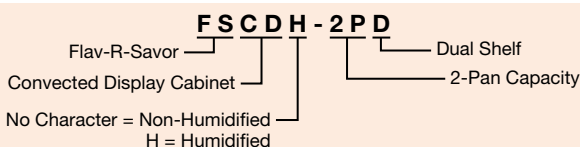



Glo-Ray® Heated Display Cases

Designed for “show and sell” areas in any foodservice operation, the Hatco Glo-Ray® Heated Display is perfect for hot food merchandising. Top and bottom heat combine to keep all food at that “just-made” taste and temperature longer.

- Thermostatically-controlled heated base (100° - 200°F) to extend holding times
- Pre-focused infrared top heat directs heat to the outer edges where heat loss is greatest
- Constructed of aluminum and stainless steel with tempered glass
- Shatter-resistant incandescent lights illuminate the food product
- Exclusive cool base construction minimizes heat transfer, keeping exterior base cool
- Rollerless sliding doors



GRHD-4PD with optional *Designer Antique Copper* and mirrored glass doors and accessory food pans



GRHDH-2P with standard pan skirt, optional double side opening, and accessory food pans

Quick-Ship Program Information Inside Back Cover

Merchandisers & Display Cases

DISPLAY CASES

Model	No. of Bulbs	Dimensions W x D x H (Height includes legs)	Voltage	Watts	Plug	Approx. Ship Weight	List Price
Single Shelf							
GRHD-2P	4	32½" x 26" x 25"	120	940	NEMA 5-15P	120 lbs.	\$7263
GRHD-3P	5	45½" x 26" x 25"	120	1350	NEMA 5-15P	143 lbs.	8311
GRHD-4P [✓]	6	58½" x 26" x 25"	120	1785	NEMA 5-20P	215 lbs.	9822
Dual Shelf							
GRHD-2PD	6	32½" x 26" x 30"	120	1310	NEMA 5-15P	150 lbs.	\$10021
✓ GRHD-3PD	8	45½" x 26" x 30"	120	1755	NEMA 5-20P	188 lbs.	11258
GRHD-4PD [✓]	8	58½" x 26" x 30"	120	2480	NEMA 5-30P	230 lbs.	12942
Single Shelf with Humidity							
GRHDH-2P	4	32½" x 26" x 25"	120	1190	NEMA 5-15P	125 lbs.	\$ 8503
GRHDH-3P	5	45½" x 26" x 25"	120	1600	NEMA 5-20P	162 lbs.	9552
GRHDH-4P [✓]	6	58½" x 26" x 25"	120	2285	NEMA 5-30P	215 lbs.	11942
Dual Shelf with Humidity							
GRHDH-2PD [♦]	6	32½" x 26" x 30"	120	1560	NEMA 5-20P	175 lbs.	\$11251
GRHDH-3PD [♦]	8	45½" x 26" x 30"	120	2005	NEMA 5-30P	188 lbs.	12488
GRHDH-4PD [♦]	8	58½" x 26" x 30"	120/208, 120/240	2980	NEMA L14-20P	240 lbs.	15055

[✓] Available in 120/208V or 120/240V.

[♦] Humidity on bottom shelf only. Includes pan skirt on bottom shelf.

All Display Case Models Feature:

Water Reservoir Capacity (Humidified models only): 2-Pan and 3-Pan: 3 quarts.
4-Pan: 6 quarts.

Doors: Separate rollerless sliding door per shelf.

Cord Location: Server side, bottom right corner.

OPTIONS AND ACCESSORIES – PAGE 178
WATER QUALITY REQUIREMENTS – PAGE 242

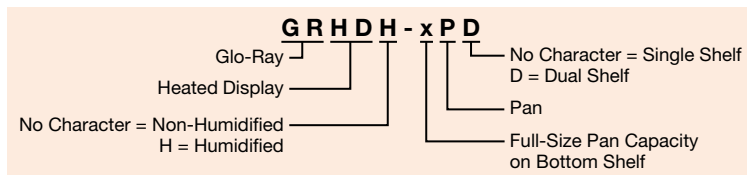

Usable Heated Shelf Space (W X D)

Model	Top Shelf	Bottom Shelf
GRHD-2P, GRHDH-2P	–	28" x 21½"
GRHD-3P, GRHDH-3P	–	41" x 21½"
GRHD-4P, GRHDH-4P	–	54" x 21½"
GRHD-2PD, GRHDH-2PD	28" x 16⅙"	28" x 21½"
GRHD-3PD, GRHDH-3PD	41" x 16⅙"	41" x 21½"
GRHD-4PD, GRHDH-4PD	54" x 16⅙"	54" x 21½"



GRHD-4PD with optional pan skirts
 Top shelf: one **UPPERSKIRT-4P**
 Bottom shelf: one **SKIRT-4P**

OPTIONS (available at time of purchase only)

SKIRT-2P	Pan Skirt on bottom shelf (standard on Humidified models) 2-Pan model in lieu of Pan Rail	\$172
SKIRT-3P	Pan Skirt on bottom shelf (standard on Humidified models) 3-Pan model in lieu of Pan Rail (consists of one SKIRT-1P and one SKIRT-2P)	240
SKIRT-4P	Pan Skirt on bottom shelf (standard on Humidified models) 4-Pan model in lieu of Pan Rail (consists of two SKIRT-2P)	342
UPPERSKIRT-2P	Pan Skirt for upper shelf of 2-Pan models in lieu of Pan Stop	172
UPPERSKIRT-3P	Pan Skirt for upper shelf of 3-Pan models in lieu of Pan Stop	342
UPPERSKIRT-4P	Pan Skirt for upper shelf of 4-Pan models in lieu of Pan Stop	342
HAL	60 Watt Halogen Bulb in lieu of Standard Display Light	each 102
FLIP	Flip-Up Doors on control side in lieu of Glass Sliding Doors	No Charge
Sliding Door in lieu of Fixed Glass customer panel –		
SLIDE-2P	Per opening	\$355
SLIDE-3P	Per opening	391
SLIDE-4P	Per opening	486
Flip-Up Door in lieu of Fixed Glass customer panel –		
FLIP-2P	Per opening	\$355
FLIP-3P	Per opening	391
FLIP-4P	Per opening	486
Mirror Glass Sliding Door in lieu of Glass Sliding Door (server side only) –		
MIRROR-2P	Per opening	\$204
MIRROR-3P	Per opening	260
MIRROR-4P	Per opening	322

OPTIONS (available at time of purchase only)

Designer Colors – Non-standard colors are non-returnable – Stainless Steel standard –		
RED	Warm Red	\$748
BLACK	Black	748
GRAY	Gray Granite	748
WHITE	White Granite	748
NAVY	Navy Blue	748
GREEN	Hunter Green	748
COPPER	Antique Copper	748

FOOD PANS AND TRIVETS – PAGE 240
COLORS AND FINISHES – PAGE 241

HEATED DISPLAY CASE MAXIMUM PAN CAPACITIES*

Model	Pan Capacity	Optional Pan Skirt Frames
GRHD-2P	2 Full-Size Pans	One SKIRT-2P
GRHD-3P	3 Full-Size Pans	One SKIRT-3P
GRHD-4P	4 Full-Size Pans	One SKIRT-4P
GRHD-2PD	Top Shelf 2 Half-Size Pans or 2-14" Pizza Pans	One UPPERSKIRT-2P
	Bottom Shelf 2 Full-Size Pans	One SKIRT-2P
GRHD-3PD	Top Shelf 3 Half-Size Pans or 3-14" Pizza Pans	One UPPERSKIRT-3P
	Bottom Shelf 3 Full-Size Pans	One SKIRT-3P
GRHD-4PD	Top Shelf 2 Full-Size Pans or 4 Half-Size Pans or 4-14" Pizza Pans	One UPPERSKIRT-4P
	Bottom Shelf 4 Full-Size Pans	One SKIRT-4P

* All pan capacities shown are for non-humidified models. 2½" deep pans recommended for bottom shelf of humidified models.



Non-Humidified Mini Display Warmers

The Hatco Mini Display Warmer is perfect for cookies, pastries, wrapped or boxed sandwiches or any other product that does not require humidity. Hot air circulates throughout the entire cabinet, keeping food at safe serving temperatures. The small footprint takes up little of your valuable counterspace while merchandising your breakfast, lunch or dinner offerings.

MDW-1X with standard *Designer Black* and optional Hood with backlit sign cutout on one side (sign included)

- Magnetically adjustable shelves allow horizontal or slanted displays
- Tempered glass sides and incandescent light
- Available as a 1- or 2-door pass-through model
- Doors may be field converted to any side
- Optional black hood with backlit graphic sign cutout that can be rotated in field to face any side (sign included)



Magnetically adjustable shelves are easy and offer quick adjustability for different food products

Merchandisers & Display Cases

MINI DISPLAY WARMERS – NON-HUMIDIFIED

Model	Description	Dimensions W x D x H	Voltage	Watts	Amps	Plug	Approx. Ship Weight	List Price
MDW-1X	1 Door w/3 Shelves	15¾" x 17" x 25½"	120	470	3.9	NEMA 5-15	46 lbs.	\$4168
MDW-2X	2 Doors w/3 Shelves	15¾" x 18¾" x 25½"	120	470	3.9	NEMA 5-15	53 lbs.	4332

All Mini Display Warmer Models Feature:

Cabinet Opening Dimensions: 12½"W x 15⅝"H.

Door Hinges: **Control Side:** Left-hand side.

Customer Side (two-door models only): Right-hand side.

Cord Location: Server side, lower right corner.

OPTIONS (available at time of purchase only)

Designer Color for Posts, Base, and Top Trim – Non-standard colors are non-returnable – Black Standard –

RED	Warm Red	No Charge
GRAY	Gray Granite	No Charge
WHITE	White Granite	No Charge
NAVY	Navy Blue	No Charge
GREEN	Hunter Green	No Charge
COPPER	Antique Copper	No Charge
BCKLIT-MDW	Hood with Backlit Sign cut out on one side - Black only (sign included)	\$213

COLORS AND FINISHES – PAGE 241

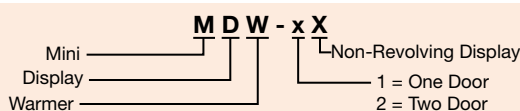



Flav-R-Fresh® Humidified Impulse Display Cabinets

A profitable way to create impulse food sales is with the small Flav-R-Fresh® Holding and Display Cabinet. Using controlled moisturized heat allows you to showcase your product longer using minimum counter space.

- Full-view display with tempered glass sides and door
- Controlled heat and humidity for longer holding times
- Accommodates half-size sheet pans
- Revolving or stationary display racks
- Single- or reversible double-sided opening models
- LED lights illuminate the holding areas and emphasize the product



FDWD-2 with accessory 4-tier circle rack

Quick-Ship Program Information *Inside Back Cover*

IMPULSE CABINETS

Model*	Description*	Dimensions W x D x H ‡	Cabinet Opening W x H	Voltage Single Phase	Watts	Approx. Ship Weight	List Price*
✓ FDWD-1	1 Door w/4-Tier Circle Rack w/Motor	19 3/8" x 20 7/8" x 28 7/8"	15 3/4" x 19 3/4"	120	1360	90 lbs.	\$6588
✓ FDWD-1X	1 Door w/4-Shelf Multi-Purpose Rack w/o Motor	19 3/8" x 20 7/8" x 28 7/8"	15 3/4" x 19 3/4"	120	1360	90 lbs.	6384
✓ FDWD-2	2 Doors w/4-Tier Circle Rack w/Motor	19 3/8" x 22" x 28 7/8"	15 3/4" x 19 3/4"	120	1360	90 lbs.	6795
FDWD-2X	2 Doors w/4-Shelf Multi-Purpose Rack w/o Motor	19 3/8" x 22" x 28 7/8"	15 3/4" x 19 3/4"	120	1360	90 lbs.	6580

- * Models FDWD-1 and FDWD-2 include rack motor. Models with "X" designator do not have revolving display and are NOT available for retrofit.
- ‡ Rack listed is included with unit. Other racks available – deduct price of included rack and add price of substituted rack to list price.
- ‡ Height includes standard 1" legs.
- * For non-humidified cabinet, deduct \$-289. Unit will only operate in dry mode.

All Impulse Cabinet Models Feature:

Voltage: 60 Hz, 11.3 amps, NEMA 5-15P plug.

Door Hinges – Control Side and Customer Side (two-door models only): Left-hand side.

Max. Pizza Size: 15" diameter with 4-Tier Circle Rack.

Water Tank Capacity for Humidity System: 1/2 gallon.

Cord Location: Facing controls, left-hand side panel, lower right corner.

WATER QUALITY REQUIREMENTS – PAGE 242

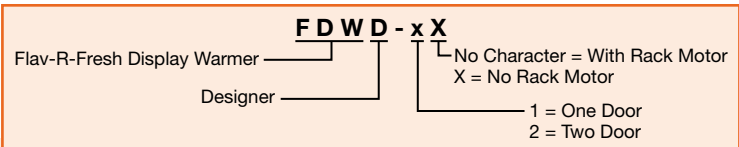

OPTIONS (available at time of purchase only)

Designer Colors – Non-standard colors are non-returnable – Clear Anodized Aluminum Standard –

RED	Warm Red	\$748
BLACK	Black	748
GRAY	Gray Granite	748
WHITE	White Granite	748
NAVY	Navy Blue	748
GREEN	Hunter Green	748
COPPER	Antique Copper	748
LED-NW18	Neutral White (cool) LED lighting (in lieu of standard Warm White)	No Charge
FDWD-SCD	Self Closing Door in lieu of standard door (left hinge only). Must upgrade both doors on FDWD-2, -2X (not field reversible)	per door \$134
FDWD-6FRT	6" Merchandising Display Sign Holder for Control Side only (Includes metal holder only). Available in all Designer Colors to match your unit (Black is standard). Adds 1 1/8" to height of unit. Requires (1) sign 19 3/16"W x 6 3/16"H x 1/16"D – not included	179
FDWD-DIS	3" One Sided Merchandising Display Sign Holder (includes metal holder and window) – one per side, three maximum. Available in all Designer Colors to match your unit (Black is standard). Adds 1 1/4" to height of unit. Requires (1) sign 19 1/16"W x 3 3/4"H x 1/16"D – not included	127
FDWD-6SIGN	6 3/8" One-Sided Merchandising Display Sign Holder (includes metal holder and window) – one per side, three maximum. Available in all Designer Colors to match your unit (Black is standard). Adds 1 1/4" to height of unit. Requires (1) sign 19 3/16"W x 6 1/4"H x 1/16"D – not included	139

ACCESSORIES (available for purchase at any time)

FDWD-LEGS	4" Adjustable Legs (4"-5")	\$132
COUPLING	Motorless Rack Coupling for FDWD-1X and FDWD-2X models (select Circle Rack or Pretzel Tree)	73
FDWD4TCRR	4-Tier Circle Rack with Pizza Pan Retainers (Requires Coupling for -1X or -2X models)	394
FDW4SMP	4-Shelf Multi-Purpose Rack (each shelf 13 3/8"W x 12 3/8"D)	445
FDW3TPT	3-Tier Pretzel Tree (requires Coupling for -1X or -2X models)	445

DECORATIVE KIT – PAGE 183

RACKS – PAGE 184

FOOD PANS AND TRIVETS – PAGE 240

COLORS AND FINISHES – PAGE 241



COUPLING Accessory



Flav-R-Savor® Humidified Holding & Display Cabinets

Balancing a precise combination of heat and humidity, the Hatco Flav-R-Savor® Cabinets provide an attractive showcase for hot food displays and generate impulse sales. A complete range of cabinet sizes, door options and rack types allows for perfect merchandising of food products such as pizza, fried foods, bakery items, sandwiches and more.

- Full-view display with tempered glass sides and door provide maximum heat retention
- Controlled heat and humidity for longer holding times
- ¾ gallon stainless water reservoir provides all day moisture
- Low-water protection prevents heating element burnout and alerts operator to low-water condition
- Revolving or stationary display racks
- Available in two heights with single-sided or double-sided openings
- Energy efficient LED lighting to illuminate your food display



FSD-1 with 3-tier pan rack and accessory food pans



FSDT-2 with 4-tier circle rack and 4" legs, optional Designer Black color and accessory food pans

Merchandisers &
Display Cases

Quick-Ship Program Information Inside Back Cover

DISPLAY CABINETS

Model*	Description*	Dimensions W x D x H	Approx. Ship Weight	List Price*
Standard				
✓ FSD-1	1 Door w/3-Tier Circle Rack w/Motor	22½" x 24½" x 27⅝"	129 lbs.	\$7969
✓ FSD-1X	1 Door w/3-Tier Pan Rack w/o Motor	22½" x 24½" x 27⅝"	126 lbs.	7730
FSD-2	2 Doors w/3-Tier Circle Rack w/Motor	22½" x 25⅝" x 27⅝"	126 lbs.	8511
FSD-2X	2 Doors w/3-Tier Pan Rack w/o Motor	22½" x 25⅝" x 27⅝"	126 lbs.	8276
Tall				
✓ FSDT-1	1 Door w/4-Tier Circle Rack w/Motor	22½" x 24½" x 32⅝"	128 lbs.	\$8104
✓ FSDT-1X	1 Door w/4-Tier Pan Rack w/o Motor	22½" x 24½" x 32⅝"	126 lbs.	7786
✓ FSDT-2	2 Doors w/4-Tier Circle Rack w/Motor	22½" x 25⅝" x 32⅝"	126 lbs.	8746
✓ FSDT-2X	2 Doors w/4-Tier Pan Rack w/o Motor	22½" x 25⅝" x 32⅝"	126 lbs.	8435

- ♦ Models FSD-1, FSD-2, FSDT-1 and FSDT-2 include rack motor. Models with "X" designator do not have revolving display and are NOT available for retrofit.
- ‡ Rack listed is included with unit. Other racks available – deduct price of included rack and add price of substituted rack to list price.
- * For non-humidified cabinet, deduct \$-289. Unit will only operate in dry mode.

All Display Cabinet Models Feature:

Voltage: 120, single phase, 60 Hz, 1414 watts, 11.8 amps, NEMA 5-15P plug.

Cabinet Opening Dimensions: Standard Models: 19"W x 18⅝"H.

Tall Models: 19"W x 23¾"H.

Door Hinges: Control Side: Left-hand side.

Customer Side (two-door models only): Right-hand side.

Max. Pan Size: 19" diameter with 4-Tier Circle Rack.

Water Tank Capacity for Humidity System: ¾ gallon.

Cord Location: Facing controls, left-hand side panel, lower right corner.

OPTIONS AND ACCESSORIES – PAGE 182

DECORATIVE KIT – PAGE 183

RACKS – PAGE 184

FOOD PANS AND TRIVETS – PAGE 240

WATER QUALITY REQUIREMENTS – PAGE 242

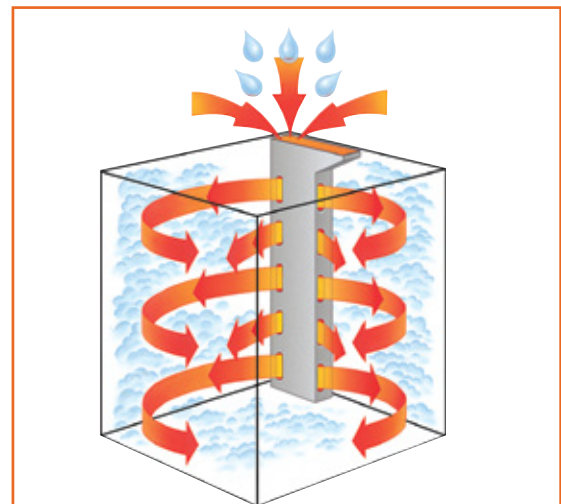

CONTROLLED MOISTURIZED HEAT KEEPS HOT FOODS FRESH LONGER Hatco's Flav-R-Savor® air flow pattern is designed to maintain consistent cabinet temperature without drying out foods. The precise combination of heat and humidity creates a "blanket" effect around the food. The air flow rate enables the cabinet to recover temperature rapidly after opening and closing the door.

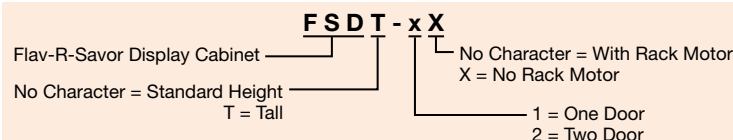



Two FSDT-1 with 4-tier circle racks, optional sign holders (signs not included) and accessory food pans

OPTIONS (available at time of purchase only)

LED-NW18	Neutral White (cool) LED lighting (in lieu of standard Neutral White)	No Charge
THERM	Mechanical Controls	No Charge
FSD7SIGN	7½" Merchandising Display Sign Holder (includes metal holder and window) – one per side , three maximum. Available in all <i>Designer Colors</i> to match your unit (Black is standard). Adds 1¼" to height of unit. Requires (1) sign 22½"W x 7½"H x 1/16"D – not included	\$145

ACCESSORIES (available for purchase at any time)

F-LEGS-4	4" Adjustable Legs	\$132
COUPLING	Motorless Rack Coupling for FSD-1X, FSD-2X, FSDT-1X and FSDT-2X models (select appropriate Circle Rack or Pretzel Tree)	73

RACKS – FSD ONLY –

FSD5SMP	5-Shelf Multi-Purpose Rack (each shelf - 18"W x 16"D)	\$599
FSD3TCR	3-Tier Circle Rack with Pizza Pan Retainers (requires Coupling for -1X or -2X models)	366
FSD3TPR	3-Tier Pan Rack (accommodates Half-Size Sheet Pans, not included)	529

RACKS – FSDT ONLY –

FSDT7SMP	7-Shelf Multi-Purpose Rack (each shelf - 18"W x 16"D)	\$ 734
FSDT4TCR	4-Tier Circle Rack with Pizza Pan Retainers (requires Coupling for -1X or -2X models)	391
FSDT5TCR	5-Tier Circle Rack with Pizza Pan Retainers (requires Coupling for -1X or -2X models)	594
FSDT4TPR	4-Tier Pan Rack (accommodates Half-Size Sheet Pans, not included)	468
FSDT3SAR	3-Shelf Angle Rack (15° angle shelves) (each shelf - 18"W x 16¼"D)	1354
FSDT3TPT	3-Tier Pretzel Tree (requires Coupling for -1X or -2X models)	639

DECORATIVE KIT – PAGE 183

RACKS – PAGE 184

FOOD PANS AND TRIVETS – PAGE 240

COLORS AND FINISHES – PAGE 241

OPTIONS (available at time of purchase only)

Designer Colors

– **Non-standard colors are non-returnable**

– **Clear Anodized Aluminum Standard –**

RED	Warm Red	\$748
BLACK	Black	748
GRAY	Gray Granite	748
WHITE	White Granite	748
NAVY	Navy Blue	748
GREEN	Hunter Green	748
COPPER	Antique Copper	748



Decorative Kit for FDWD, FSD, FSDT models only

Transform your Hatco Flav-R-Savor® Holding & Display Cabinet from a "heated box" into a *Designer Merchandiser* with a variety of simple accessory additions. Create a new look and feel to your decór.

- The curved hinged header allows easy access to controls and water fill cup, and gives a great area to brand your food product with a magnetic sign (sign not included)
- The base skirt completes the transformation and gives an additional branding area. Available in flat or curved panels for front and/or back of unit
- Signs can be decals or magnetic
- Signs not included

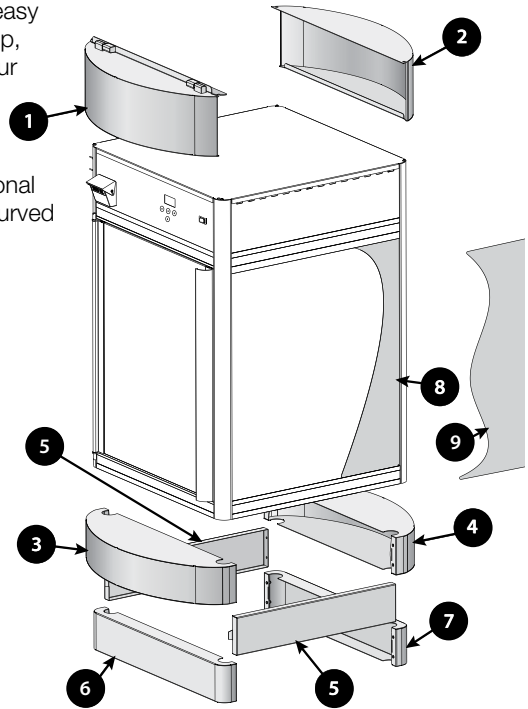

Merchandisers & Display Cases

OPTIONS (available at time of purchase only) (additional lead time required)

Designer Colors – Non-standard colors are non-returnable – Black Standard –			
RED	WR	Warm Red	No Charge
GRAY	GG	Gray Granite	No Charge
WHITE	WG	White Granite	No Charge
NAVY	NB	Navy Blue	No Charge
GREEN	HG	Hunter Green	No Charge
COPPER	AC	Antique Copper	No Charge

ACCESSORIES (available for purchase at any time)

Side Insets – Must choose Designer Color – Black Standard –

FSD-INSET1	Two Crescent Inset Panels for FSD models	\$143
FSD-INSET2	Two Wave Inset Panels for FSD models	143
FSDT-INSET1	Two Crescent Inset Panels for FSDT models	143
FSDT-INSET2	Two Wave Inset Panels for FSDT models	143
FDWD-INSET1	Two Crescent Inset Panels for FDWD models	143
FDWD-INSET2	Two Wave Inset Panels for FDWD models	143

Top Covers – Must choose Designer Color – Black Standard – Signs not Included –

FSD-CTLH	Curved Hinged Header on control side (Fits 24"W x 5 ⁷ / ₈ "H sign) for FSD and FSDT models	\$496
FDWD-CTLH	Curved Hinged Header on control side (Fits 20 ¹ / ₂ "W x 4 ⁷ / ₈ "H sign) for FDWD models	421
FSD-CUSH	Curved Header on non-control side (Fits 24"W x 5 ⁷ / ₈ "H sign) for FSD and FSDT models	361
FDWD-CUSH	Curved Header on non-control side (Fits 20 ¹ / ₂ "W x 4 ⁷ / ₈ "H sign) for FDWD models	309

Base Skirts – Requires 4" adjustable legs (not included) – Must choose Designer Color – Black Standard – Signs not Included –

FSD-SQB	One Flat Front Panel (Fits 20"W x 3 ³ / ₄ "H sign) and one Flat Back Panel (Fits 20"W x 3 ³ / ₄ "H sign) and two Flat Side Panels (Fits 18 ³ / ₈ "W x 3 ³ / ₄ "H sign) for FSD and FSDT models	\$ 427
FDWD-SQB	One Flat Front Panel (Fits 17 ¹ / ₄ "W x 3 ³ / ₄ "H sign) and one Flat Back Panel (Fits 17 ¹ / ₄ "W x 3 ³ / ₄ "H sign) and two Flat Side Panels (Fits 15 ¹ / ₂ "W x 3 ³ / ₄ "H sign) for FDWD models	556
FSD-1CB	One Curved Front Panel (Fits 25 ¹ / ₂ "W x 3 ³ / ₄ "H sign) and one Flat Back Panel (Fits 25 ¹ / ₂ "W x 3 ³ / ₄ "H sign) and two Flat Side Panels (Fits 18 ³ / ₈ "W x 3 ³ / ₄ "H sign) for FSD and FSDT models	766
FDWD-1CB	One Curved Front Panel (Fits 22 ¹ / ₄ "W x 3 ³ / ₄ "H sign) and one Flat Back Panel (Fits 22 ¹ / ₄ "W x 3 ³ / ₄ "H sign) and two Flat Side Panels (Fits 15 ¹ / ₂ "W x 3 ³ / ₄ "H sign) for FDWD models	745
FSD-2CB	One Curved Front Panel (Fits 25 ¹ / ₂ "W x 3 ³ / ₄ "H sign) and one Curved Back Panel (Fits 25 ¹ / ₂ "W x 3 ³ / ₄ "H sign) and two Flat Side Panels (Fits 18 ³ / ₈ "W x 3 ³ / ₄ "H sign) for FSD and FSDT models	1103
FDWD-2CB	One Curved Front Panel (Fits 22 ¹ / ₄ "W x 3 ³ / ₄ "H sign) and one Curved Back Panel (Fits 22 ¹ / ₄ "W x 3 ³ / ₄ "H sign) and two Flat Side Panels (Fits 15 ¹ / ₂ "W x 3 ³ / ₄ "H sign) for FDWD models	939
F-LEGS-4	4" Adjustable Legs for FSD and FSDT models	\$132
FDWD-LEGS	4" Adjustable Legs for FDWD models	132

COLORS AND FINISHES – PAGE 241



FSDT-1 with 4-tier circle rack and full Decorative Kit (signs not included)



Display Rack Selections

Racks For FDWD Models (Page 180)

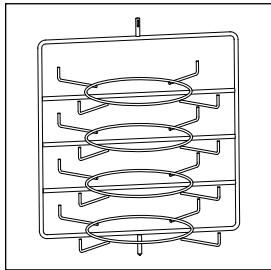

4-Tier Circle Rack
FDWD4TCRR
(Max. 15" dia. pans)
(3/4" between tiers)

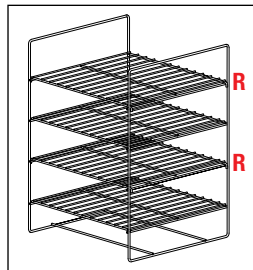

4-Shelf Multi-Purpose Rack
FDW4SMP
(Max. 18" x 13")
(3/4" between shelves)

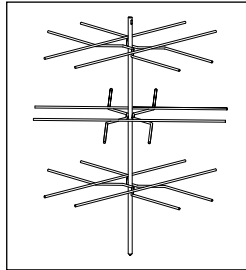

3-Tier Pretzel Tree
FDW3TPT
(5/8" between tiers)

Racks For FSD Models (Page 181)

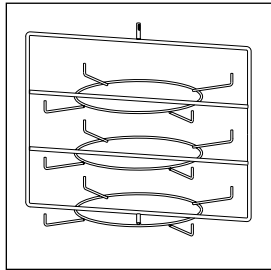

3-Tier Circle Rack
FSD3TCR
(4 5/8" between tiers)

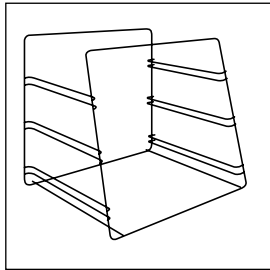

3-Tier Pan Rack
FSD3TPR
(3 1/2" between shelves)

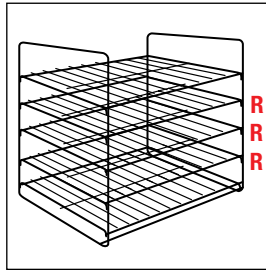

5-Shelf Multi-Purpose Rack
FSD5SMP
(2 1/2" between shelves)

Racks For FSDT Models (Page 181)

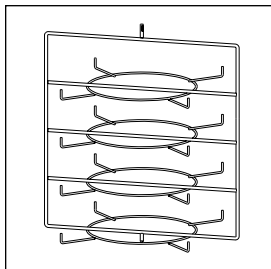

4-Tier Circle Rack
FSDT4TCR
(Max. 19" dia. pans)
(4 5/8" between tiers)

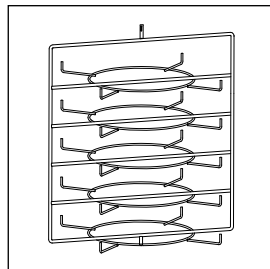

5-Tier Circle Rack
FSDT5TCR
(Max. 19" dia. pans)
(3 7/8" between tiers)

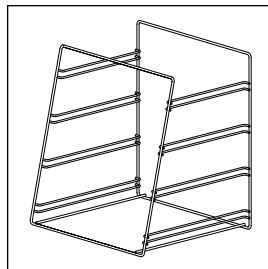

4-Tier Pan Rack
FSDT4TPR
(Max. 18" x 13" Half-Size Sheet
Pans) (3 1/2" between tiers)

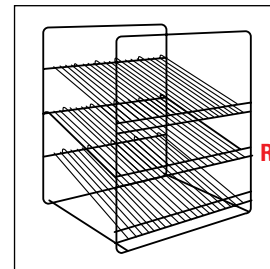

3-Shelf Angle Rack
FSDT3SAR
(3 1/2" between shelves)

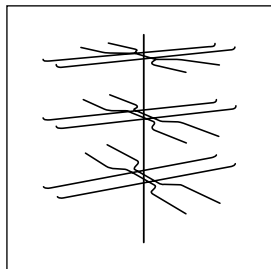

3-Tier Pretzel Tree
FSDT3TPT
(5 7/8" between tiers)

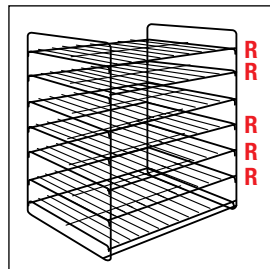

7-Shelf Multi-Purpose Rack
FSDT7SMP
(Max. 18" x 13" Half-Size Sheet
Pans) (2 1/2" between shelves)

R Removable Shelves



Macho Nacho® Chip Warmers

Keep your nacho chips hot, fresh and crisp with Hatco's Macho Nacho® Chip Warmer. This highly-visible heated merchandiser circulates air to prevent the loss of natural oils, eliminating the need to frequently replace stale chips.

- Keeps chips hot, fresh and crisp longer, reducing refill time and minimizing waste

- Specialty cabinets to hold and/or merchandise bulk nacho chips
- Special ductwork forces dry heat through chips from the bottom up
- Special two-door access for easy loading and serving
- 25 lb. or 40 lb. capacity
- Shatter-resistant incandescent lights illuminate the holding areas and emphasize the product



FDWD-1-MN



FST-1-MN shown in standard Bronze

Merchandisers & Display Cases

CHIP WARMERS – NON-HUMIDIFIED

Model	Dimensions W x D x H	Product Capacity	Voltage	Watts	Plug	Approx. Ship Weight	List Price
FDWD-1-MN	19 ³ / ₈ " x 24" x 28 ⁷ / ₈ "	25 lbs.	120	1080	NEMA 5-15P	101 lbs.	\$6530
FST-1-MN	22 ⁷ / ₈ " x 27" x 32 ⁷ / ₈ "	40 lbs.	120	1245	NEMA 5-15P	132 lbs.	9127

All Chip Warmer Models Feature:

Cabinet Opening: FDWD-1-MN: Upper Door: 16³/₈"W x 9³/₈"H.
 Lower Door: 16³/₈"W x 9³/₈"H.
 FST-1-MN: Upper Door: 18⁵/₈"W x 11¹/₄"H.
 Lower Door: 18⁵/₈"W x 9³/₈"H.

Decal Size: FDWD-1-MN: 16³/₈"W x 5¹/₂"H.
 FST-1-MN: 18⁵/₈"W x 6"H.

Cord Location: Facing controls, left-hand side panel, lower right corner.

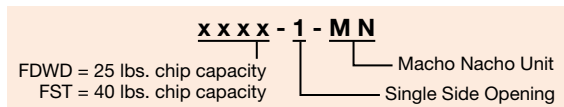



Flav-R-Savor® Humidified Large Capacity Display Cabinets

Hatco Large Capacity Holding Cabinets hold more product at proper serving temperatures than standard size models. This allows for food to be prepared in advance of peak serving periods, while placing product in full-view cabinets to increase impulse sales.

- Full-view display with tempered glass sides and LED lighting to illuminate holding area
- Optional self-closing sliding doors for self-serve applications
- Optional self-closing French doors,
- Optional cool LED lighting and 4" adjustable legs available
- Multi-purpose display racks included



WFST-2X with 4-shelf multi-purpose rack, optional *Designer Warm Red*, self-closing sliding doors and accessory food pans, and 4" legs



WFST-1X with 4-shelf multi-purpose rack. Decals and pans not included

Merchandisers & Display Cases

HUMIDIFIED LARGE CAPACITY CABINETS

Model	Description	Dimensions W x D x H	Voltage	Watts	Amps	Plugs	Approx. Ship Weight	List Price
WFST-1X	2 Doors w/4-Shelf Rack	32 $\frac{1}{8}$ " x 25 $\frac{1}{4}$ " x 32 $\frac{3}{4}$ "	120 or 120/208-240	1715 or 2315	14.3	NEMA 5-20P	182 lbs.	\$13941
WFST-2X	4 Doors w/4-Shelf Rack	32 $\frac{1}{8}$ " x 27 $\frac{3}{8}$ " x 32 $\frac{3}{4}$ "	120 or 120/208-240	1715 or 2315	14.3	NEMA 5-20P	188 lbs.	14899

All Humidified Large Capacity Cabinet Models Feature:

Cabinet Opening Dimensions: 28"W x 21 $\frac{1}{8}$ "H.
Available Shelf Space: 26 $\frac{1}{4}$ "W x 19 $\frac{3}{4}$ "D. Holds one full-size sheet pan per shelf.
Water Tank Capacity for Humidity System: $\frac{3}{4}$ gallon.
Cord Location: Server side, left-hand side panel, lower right corner.

WATER QUALITY REQUIREMENTS – PAGE 242

OPTIONS (available at time of purchase only)

Designer Colors – Non-standard colors are non-returnable –
– Clear Anodized Aluminum Standard –

RED	Warm Red	\$748
BLACK	Black	748
GRAY	Gray Granite	748
WHITE	White Granite	748
NAVY	Navy Blue	748
GREEN	Hunter Green	748
COPPER	Antique Copper	748
1SLIDE-DR	Self-closing Sliding Doors in lieu of standard Hinged Doors (WFST-2X only)	\$752
FRSELFCL	Self-Closing French Doors	per side 231
WFST-TTC	Temperature Control Timer - 6 channel control touchscreen display	891
LED-NW18	Neutral White (cool) LED lighting (in lieu of standard Warm White)	No Charge

ACCESSORIES (available for purchase at any time)

FSTCR-LEG	4" Adjustable Legs	\$127
------------------	--------------------	--------------

FOOD PANS AND TRIVETS – PAGE 240

COLORS AND FINISHES – PAGE 241

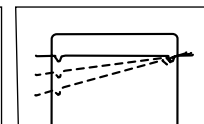
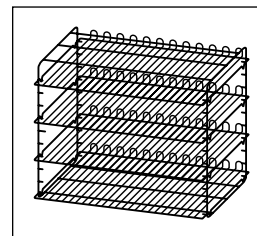

WFST 4-Shelf Multi-Purpose Rack
Adjustable Shelves in 2" increments

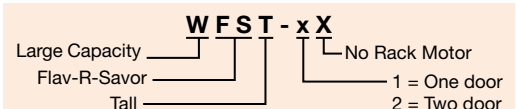



Flav-R-Savor® Non-Humidified Large Capacity Display Cabinets

When capacity is an issue, Hatco's Large Capacity Holding Cabinet is perfect for wrapped or bagged product. Designed to hold prepared foods for prolonged periods of time, while maintaining that "just-made" quality, allows for advanced preparation of peak serving periods.

- Countertop cabinets with self-closing French-style glass doors
- Standard sign holders on all four sides of the cabinet (signs not included)
- Full-view display with tempered glass sides and incandescent lights to illuminate holding area
- Multi-purpose display rack included
- Perfect for large quantities of wrapped or boxed food
- Holds two standard sheet pans side-by-side on three shelves for increased product visibility and easy accessibility

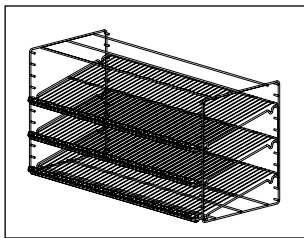

LFST 3-Shelf Multi-Purpose Rack with adjustable shelves in 2" increments

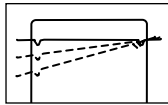

LFST-48-2X with 3-shelf multi-purpose rack, sign holders (signs not included) and optional *Designer Warm Red*

Merchandisers &
Display Cases

NON-HUMIDIFIED LARGE CAPACITY CABINETS

Model®	Bulbs	Description	Dimensions W x D x H	Plug	Approx. Ship Weight	List Price
LFST-48-1X	6	Front Glass, Back French Doors	48 ⁷ / ₈ " x 25 ³ / ₈ " x 30"	NEMA L14-20P	222 lbs.	\$18448
LFST-48-2X	6	Front and Back French Doors	48 ⁷ / ₈ " x 27 ¹ / ₈ " x 30"	NEMA L14-20P	230 lbs.	19488

Ⓜ When no color is specified, unit will be black.

All Non-Humidified Large Capacity Cabinet Models Feature:

Voltage: 120/208-240, 2150 watts, 14.6 amps.

Cabinet Opening Dimensions: 44"W x 22"H.

Available Shelf Space: 41³/₄"W x 17"D. Holds three, half-size sheet pans per shelf.

Cord Location: Server side, left-hand side panel, lower right corner.

OPTIONS (available at time of purchase only)

Designer Colors – Non-standard colors are non-returnable – Black Standard –

CLEAR	Clear Anodized Aluminum	No Charge
RED	Warm Red	No Charge
GRAY	Gray Granite	No Charge
WHITE	White Granite	No Charge
NAVY	Navy Blue	No Charge
GREEN	Hunter Green	No Charge
COPPER	Antique Copper	No Charge
HAL	60 Watt Halogen Bulb in lieu of Standard Display Light	each \$102

FOOD PANS AND TRIVETS – PAGE 240

COLORS AND FINISHES – PAGE 241

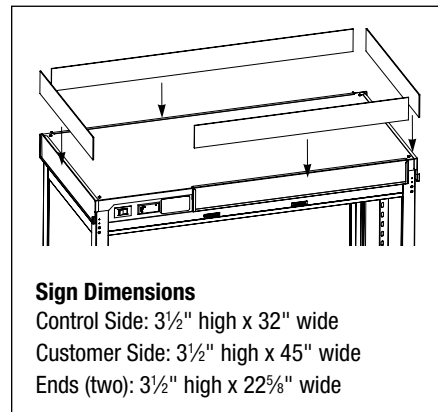

Sign Dimensions

Control Side: 3¹/₂" high x 32" wide
 Customer Side: 3¹/₂" high x 45" wide
 Ends (two): 3¹/₂" high x 22⁵/₈" wide

LFST Cabinet comes with sign holders attached on all four sides, with clear plastic inserts (signs not included)

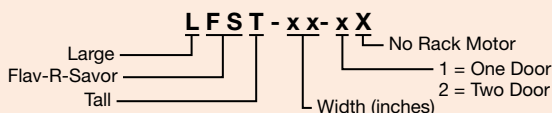



Intelligent Heated Display Cabinets with Humidity

Hatco's Intelligent Heated Display Cabinet Humidified is the perfect way to showcase your pizzas and more. Regulating air temperature while at the same time balancing the humidity levels provides the best environment for food products. With 360° viewing, your food is

guaranteed to get all the attention.

- Air flow pattern is designed to maintain consistent cabinet temperature without drying out food
- Air flow system enables the cabinet to recover temperature rapidly after opening and closing the door
- LCD touchscreen display on back of unit controls temperature, humidity and up to eight timers for each food location
- Energy efficient LED lighting to illuminate your food display
- USB port on back of unit makes it easy to update firmware
- Adjustable arms can move up and down the back supports
 - IHDCH-45 can hold up to six pizza arms, can be adjusted up to 19.5" and can hold up to 8.5 lbs.
 - IHDCH-28 arms will hold up to a 22" pizza pan

Merchandisers & Display Cases



IHDCH-45 shown with three optional shelves and French Front Doors



IHDCH-45 shown with accessory arms and risers



IHDCH-28 shown with accessory two arms and one shelf and optional front door

NOTE: Water filter, water strainer and plastic tubing are included with each cabinet to be installed on water supply connection.

INTELLIGENT HEATED DISPLAY CABINETS – HUMIDIFIED

Model	Dimensions W x D x H	Cabinet Opening Dimensions (W x H)	Voltage	Watts	Amps	Plugs	Approx. Ship Weight	List Price
IHDCH-28	28 ¹ / ₄ " x 28 ³ / ₄ " x 30 ¹ / ₄ "	22" x 20 ⁵ / ₈ "	208, 240	3090	14.9 or 12.9	NEMA 6-20P	220 lbs.	\$18494
IHDCH-45	45" x 28 ³ / ₄ " x 30 ¹ / ₄ "	18" x 20 ⁷ / ₈ "	208, 240	3090	14.9 or 12.9	NEMA 6-20P	270 lbs.	19758

All Intelligent Heated Display Cabinet Models Feature:

Models Shipped With: IHDCH-28: Stainless Steel unit with single french door, touchscreen controller, a lighted Power On/Off (I/O) switch, an air heating/circulation system, a humidity system, a USB port and LED display lights.

IHDCH-45: Stainless Steel unit with sliding glass doors, touchscreen controller, a lighted Power On/Off (I/O) switch, an air heating/circulation system, a humidity system, a USB port, LED display lights and four adjustable arms.

Cord Location: Server side, lower left corner.

OPTIONS AND ACCESSORIES – PAGE 189
WATER QUALITY REQUIREMENTS – PAGE 242

On all Intelligent Heated Display Cabinet Models customers must purchase arms and shelves separately to their own specifications.

Below are the options available to combine the shelves and arms

IHDCH-28

- 4 Arms**
- 3 Shelves**
- 1 Shelf with 1 Pizza Arm**
- 1 Shelf with 2 Pizza Arms**
- 2 Shelves with 1 Pizza Arm**

IHDCH-45

- 6 Arms**
- 3 Slanted Shelves**
- 1 Shelf with 2 Pizza Arms**
- 1 Shelf with 4 Pizza Arms**
- 2 Shelves with 2 Pizza Arms**

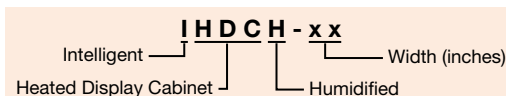



Merchandisers & Display Cases

IHDCH-45 shown with accessory arms, accessory risers and sign holders

OPTIONS (available at time of purchase only)

Designer Colors – Non-standard colors are non-returnable – Stainless Steel Standard –

IHDCH-BK	Unit in <i>Designer</i> Black in lieu of Stainless Steel unit	\$ 748
IHDCHBASE-BK-28	Inside base in <i>Designer</i> Black in lieu of Stainless Steel base for IHDCH-28	54
FRDTCR-28	Front, swing out door for IHDCH-28, left-hand hinge standard, matches unit color (adds 2" to depth)	1399
IHDCHBASE-BK-45	Inside base in <i>Designer</i> Black in lieu of Stainless Steel base for IHDCH-45	54
FRFRDTCR-45	Front, self-closing French doors for IHDCH-45, matches unit color (adds 2" to depth)	2652

ACCESSORIES (available for purchase at any time)

ADJARM-SS	Pizza Arm in Stainless Steel	each \$288
ADJARM-BK	Pizza Arm in <i>Designer</i> Black	each 348
SHELF-SS-28	Shelf in Stainless Steel for IHDCH-28	each 388
SHELF-BK-28	Shelf in <i>Designer</i> Black for IHDCH-28	each 388
SHELF-SS-45	Shelf in Stainless Steel for IHDCH-45	each 573
SHELF-BK-45	Shelf in <i>Designer</i> Black for IHDCH-45	each 993
RISER12-SS	12" diameter x 1½" H Riser in Stainless Steel	44
RISER12-BK	12" diameter x 1½" H Riser in <i>Designer</i> Black	63
DOORLOCKIHDCH	Front Door lock for IHDCH-28 only	40
REGKIT	Water Pressure Regulator Kit (regulator, gauge and shut-off valve)	606

SIGN HOLDERS (signs not included) – recommended sign size: 2" x 3.5" –

SGNHOLD-BASE-SS	Sits on base of unit in Stainless Steel	each \$28
SGNHOLD-BASE-BK	Sits on base of unit in <i>Designer</i> Black	each 52
SGNHOLD-LARM-SS	Customer left-hand side in Stainless Steel (clips onto Arm)	each 32
SGNHOLD-LARM-BK	Customer left-hand side in <i>Designer</i> Black (clips onto Arm)	each 61
SGNHOLD-RARM-SS	Customer right-hand side in Stainless Steel (clips onto Arm)	each 32
SGNHOLD-RARM-BK	Customer right-hand side in <i>Designer</i> Black (clips onto Arm)	each 61

FOOD PANS AND TRIVETS – PAGE 240

COLORS AND FINISHES – PAGE 241



Product Heated Shelves

Perfect for sliced pizza sales on the bottom, and boxed carry-out pizzas on the top. Durable stainless steel construction with blanket elements on all shelf bases make for easy cleaning. The bottom, three shelf PDH-55T has energy efficient LED lights to showcase food to customers and encouraging impulse sales. The top dual shelf PSH-55D holds the carry-out orders.

PDH-55T (bottom three-shelf unit)

- Holds up to nine, 18" diameter pizzas
- Base and overhead heat for consistent and accurate holding of unwrapped pizzas for impulse sales
- Optional front glass for easy viewing by the customer
- Single on/off switch to control temperature for all shelves
- Standard side panel glass swings out for easy cleaning

PSH-55D (top two-shelf unit)

- Enclosed except for operator side, with base heat only, for boxed carry out sales
- Single on/off switch to control temperature for all shelves
- Customer side can be used for magnetic signage (signs not included)
- Brackets and cord clips included to attach to the top of the PDH-55T



Customer side shown
PSH-55D top unit
PSD-55T bottom unit with optional front glass panels



Operator side shown
PSH-55D top unit
PSD-55T bottom unit with optional front glass panels

Merchandisers & Display Cases

PRODUCT HEATED SHELVES

Model	Dimensions W x D x H	Usable Heated Shelf Space (W x D)	Voltage	Watts	Amps	Plug	Approx. Ship Weight	List Price
Dual Shelf								
PSH-55D	54 ⁵ / ₈ " x 20" x 16"	51 ¹ / ₂ " x 18 ³ / ₄ "	120	300	2.54	NEMA 5-15P	193 lbs.	\$7202
Triple Shelf								
PDH-55T	54 ¹ / ₂ " x 20 ¹ / ₈ " x 31 ¹ / ₈ " ‡	51 ¹ / ₂ " x 18 ³ / ₄ "	120/208-240	4100	17.5	NEMA L14-30P	168 lbs.	\$16202

‡ Height includes 2.5" legs.

All Product Heated Shelf Models Feature:

Cord Location: PSH-55D: Server side, bottom right
PDH-55T: Server side, bottom right on base.

OPTIONS (available at time of purchase only)

PDHGLSSPNL Glass Panels on customer side on PDH-55T only **\$1433**

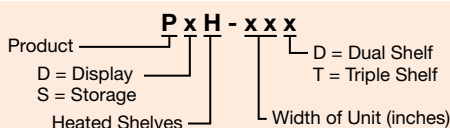

Holding Cabinets





Flav-R-Savor® Portable Holding Cabinets

Hatco's energy efficient Flav-R-Savor® Portable Holding Cabinets will keep prepared foods at optimum serving temperatures for hours. The thermostatically-controlled heat and humidity allows food to be prepared in advance of peak serving periods.

- Allows you to hold product longer while saving you money through increased energy efficiencies
- Electronic control with digital read out, temperature range of 80°- 200°F and humidity controller
- The lower temperature range of 80°-100°F can be used for proofing all types of breads
- All stainless steel interior
- No heating element in direct contact with water makes the unit easier to clean
- Accommodates Gastronorm pans
- Electrical components, controls and digital temperature readout are located at the top for easy access
- Stacking kit available
- Doors are field convertible from left to right



FSHC-7W1-EE shown in Designer Black, with optional bumper kit, and right-hand hinged door



PORTABLE HOLDING CABINETS

Model	Description	Dimensions			Voltage	Hz	Watts	Amps	Plug	Approx. Ship Weight	List Price
		W x D x H <small>Height includes standard casters</small>									
FSHC-5W1-EE	Single Door	26 1/8"	x 31 1/4"	x 36"	120	60	1118	9.3	NEMA 5-15P	250 lbs.	\$13282
FSHC-7W1-EE	Single Door	26 1/8"	x 31 1/4"	x 39"	120	60	1118	9.3	NEMA 5-15P	222 lbs.	13971
FSHC-7W2-EE	2-Door Pass-Through	26 1/8"	x 34 5/8"	x 39"	120	60	1118	9.3	NEMA 5-15P	232 lbs.	14763

All Portable Holding Cabinet Models Feature:

Interior Cabinet Capacity: 20 7/8"W x 26 7/8"D.

Top Surface Dimensions: 25 3/4"W x 28 1/2"D.

Models Shipped with: 6' cord and plug, 4" diameter casters (with 5 1/8" clearance), stainless steel heavy-duty door with left-hand door hinge, and adjustable rack slides (seven for the -7WX-EE units, and five for the -5W1-EE unit).

Pan Capacity: -5W1-EE: 10 full sized sheet pans or 2/1 Gastronorm pans on 1 3/8" spacing, 5 full sized sheet pans or 2/1 Gastronorm pans on 3/4" spacing, 10 full sized hotel pans or 1/1 Gastronorm pans on 1 3/8" spacing.
-7Wx-EE: 14 full sized sheet pans[□] or 2/1 Gastronorm pans on 1 3/8" spacing, 7 full sized sheet pans or 2/1 Gastronorm pans on 2 3/4" spacing, 14 hotel sized pans or 1/1 Gastronorm pans on 1 3/8" spacing.

Water Tank Capacity for Humidity System: 1 gallon.

Cord Location: Recessed, back of unit, upper right side.

[□] With purchase of extra pan slides.



FSHC-7W1-EE & FSHC-7W2-EE (120V models only) NOTE: Units equipped with a heavy-duty glass door(s) are not ENERGY STAR qualified

WATER QUALITY REQUIREMENTS – PAGE 242

OPTIONS (available at time of purchase only)

Colors (Side Panels) – Non-standard colors are non-returnable – Black Standard –		
SS	Stainless Steel	\$360
Colors (Top) – Non-standard colors are non-returnable – Black Standard –		
SS	Stainless Steel	360
EE-GLASS	Glass Door (in lieu of stainless steel door) (is not Energy Star qualified)	\$446
EE-LPCAST	Low Profile Casters (FSHC-5W1-EE model only) (deduct 2 1/4" from height)	No Charge
EE-PLATFORM	Platform for mounting directly on a counter (in lieu of casters) (deduct 4 1/8" from height)	No Charge
EE-STACK-BLK	Designer Black Powdercoated Stacking Hardware mounted to bottom of Cabinet for two FSHC-7W1 or two FSHC-5W1 units in lieu of casters (cannot have Legs on lower unit)	No Charge
EE-STACK-SS	Stainless Steel Stacking Hardware mounted to bottom of cabinet for two FSHC-7W1 or two FSHC-5W1 units in lieu of Casters (cannot have legs on lower unit)	No Charge
EE-BUMPER	Bumper Hardware (only for use with standard casters) (add 1/8" to height)	860
EE-4LEGS	4" Legs in lieu of Casters (deduct 1/2" from height)	No Charge
EE-6LEGS	6" Legs in lieu of Casters (add 1 1/4" to height)	No Charge

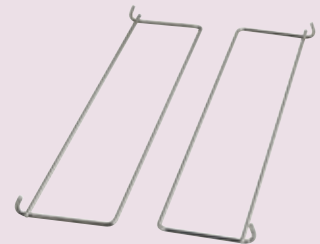

EE-1-SLIDE Accessory

ACCESSORIES (available for purchase at any time)

EE-1-SLIDE	Extra Pan Slides	pair \$165
------------	------------------	-------------------

FOOD PANS AND TRIVETS – PAGE 240

COLORS AND FINISHES – PAGE 241





Flav-R-Savor® Low Profile, Humidified, Portable Holding Cabinets

Prepare food in advance of peak serving periods and safely hold it at optimum serving temperatures with the Flav-R-Savor® Portable Holding Cabinet. Thermostatically-controlled heat and humidity allows you to hold product for hours.

- Thermostatically-controlled heat and humidity holds hot food at optimum serving temperatures longer
- Allows preparation of food in advance of peak serving periods
- Accommodates Gastronorm pans
- Electrical components, controls, water reservoir and digital temperature readout are located at the top for easy access
- Reduced height – less than 30" high, and wider footprint for increased capacity
- Insulated side walls, field reversible glass doors, large swivel casters with wheel locks and 6' recessed cord and plug are standard
- Stacking kit available



FSHC-6W1 with accessory food pans

Quick-Ship Program Information Inside Back Cover

LOW PROFILE HOLDING CABINETS – HUMIDIFIED

Model	Description	Dimensions (W x D x H) <i>Height includes standard casters</i>	Cabinet Opening (W x H)	Top Surface Dimensions (W x D)	Plug	Approx. Ship Weight	List Price
✓ FSHC-6W1	1 Door	25½" x 29¾" x 32⅞"	21½" x 19"	25⅝" x 25⅝"	NEMA 5-20P	167 lbs.	\$ 11233
FSHC-6W2	2 Doors	25½" x 32" x 32⅞"	21½" x 19"	25⅝" x 25⅝"	NEMA 5-20P	180 lbs.	12021

⚠ FSHC-6W2 is a two-door pass-through single cabinet, not two units stacked.

All Low Profile Holding Cabinet Models Feature:

Voltage: 120, 60 Hz, 1697 watts, 14.1 amps.

Models Shipped with: 6' cord and plug, 4" diameter casters (with 5⅞" clearance), six sets of adjustable angle slides.

Pan Capacity: Six 18"W x 26"D sheet pans or six 2/1 Gastronorm pans on 3" centers, eleven 18"W x 26"D sheet pans[⌘], eleven 2/1 Gastronorm pans on 1½" centers[⌘], or twelve 20"W x 12"D x 2½"H hotel pans[⌘].

Water Tank Capacity for Humidity System: ¾ gallon.

Cord Location: Recessed, back of unit, upper right side.

[⌘]With purchase of extra pan slides.

WATER QUALITY REQUIREMENTS – PAGE 242

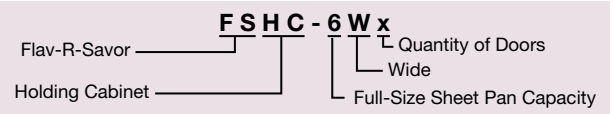

OPTIONS (available at time of purchase only)

Colors (Side Panels) – Non-standard colors are non-returnable – Silver Gray Standard –		
BLACK	Designer Black	\$360
SS	Stainless Steel	360
Colors (Top) – Non-standard colors are non-returnable – Silver Gray Standard –		
BLACK	Designer Black	\$360
SS	Stainless Steel	360
6W-SS-DR	Stainless Steel Door in lieu of Glass Door	\$156
HD-SS-DR	Heavy-Duty Stainless Steel Door with Positive Latch Handle	640
6W1-LPCAST	2" Low Profile Locking Casters in lieu of standard Casters (2" diameter with 3" clearance - Overall height is 29¾")	No Charge
6W1-STACK	Stacking Hardware mounted to top of Cabinet for two FSHC-6W1 Units in lieu of Casters (Silver Gray)	147
CORDWIND	Bracket for holding Cord during transport	59

ACCESSORIES (available for purchase at any time)

6W1-SLIDE	Extra Pan Slides	pair \$165
-----------	------------------	------------

FOOD PANS AND TRIVETS – PAGE 240

COLORS AND FINISHES – PAGE 241

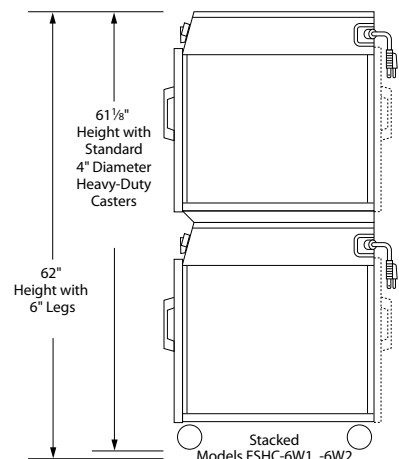
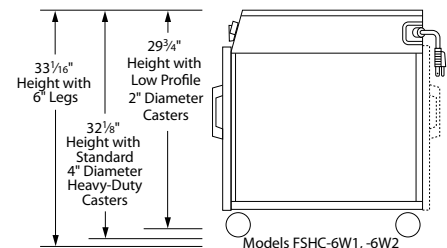



Flav-R-Savor® Humidified Portable Holding Cabinets

Prepare food in advance of peak serving periods and safely hold it at optimum serving temperatures with the Flav-R-Savor® Portable Holding Cabinet. Thermostatically-controlled heat and humidity allows you to hold product for hours.

- Thermostatically-controlled heat and humidity holds hot food at optimum serving temperatures longer
- Allows preparation of food in advance of peak serving periods
- Accommodates Gastronorm pans
- Electrical components, controls, water reservoir and digital temperature readout are located at the top for easy access
- Insulated side walls, field reversible glass doors, large swivel casters with wheel locks and 6" recessed cord and plug are standard
- Stacking kit available



FSHC-7-1 with standard 4" casters and accessory food pans

PORTABLE HOLDING CABINETS – HUMIDIFIED

Model	Description	Dimensions (W x D x H) <i>Height includes standard casters</i>	Cabinet Opening (W x H)	Top Surface Dimensions (W x D)	Plug	Approx. Ship Weight	List Price
FSHC-7-1	1 Door	22 ³ / ₄ " x 29 ⁵ / ₈ " x 35 ¹ / ₈ "	18 ¹ / ₂ " x 22"	22 ⁵ / ₈ "W x 25 ⁷ / ₈ "	NEMA 5-20P	175 lbs.	\$11335
FSHC-7-2 [†]	2 Doors	22 ³ / ₄ " x 32" x 35 ¹ / ₈ "	18 ¹ / ₂ " x 22"	22 ⁵ / ₈ "W x 25 ⁷ / ₈ "	NEMA 5-20P	180 lbs.	12129

[†] FSHC-7-2 is a two-door pass-through single cabinet, not two units stacked.

All Portable Holding Cabinet Models Feature:

Voltage: 120, 60 Hz, 1697 watts, 14.1 amps.

Models Shipped with: 6' cord and plug, 4" diameter casters (with 5¹/₈" clearance), seven sets of adjustable angle slides for 18" x 26" pans or 12" x 20" pans.

Pan Capacity: Seven 18" x 26" sheet pans on 3" centers, seven 20" x 12" x 2¹/₂" hotel pans or seven 1/1 Gastronorm pans.

Water Tank Capacity for Humidity System: 3/4 gallon.

Cord Location: Recessed, back of unit, upper right side.

WATER QUALITY REQUIREMENTS – PAGE 242

OPTIONS (available at time of purchase only)

Colors (Side Panels) – Non-standard colors are non-returnable – Silver Gray Standard –

BLACK	Designer Black	\$360
SS	Stainless Steel	360

Colors (Top) – Non-standard colors are non-returnable – Silver Gray Standard –

BLACK	Designer Black	\$360
SS	Stainless Steel	360

SS-DR Stainless Steel Door in lieu of Glass Door \$156

HD-SS-DR Heavy-Duty Stainless Steel Door with Positive Latch Handle 640

LWALARM Audible Low-Water Alarm 145

LPCAST 2" Low Profile Casters in lieu of Standard Casters (2" diameter with 3" clearance - Overall Height 32³/₄") 59

4LEGS 4" Adjustable Legs in lieu of standard Casters No Charge

6SS 6" Stainless Steel Legs in lieu of standard Casters No Charge

7-1-STACK Stacking Hardware mounted to top of cabinet for two FSHC-7-1 units in lieu of Casters (Silver Gray) 205

CORDWIND Bracket for holding cord during transport 59

ACCESSORIES (available for purchase at any time)

SLIDEWIRE	Wire Shelf	per shelf \$218
-----------	------------	-----------------

FOOD PANS AND TRIVETS – PAGE 240

COLORS AND FINISHES – PAGE 241

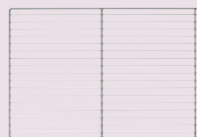

SLIDEWIRE Accessory

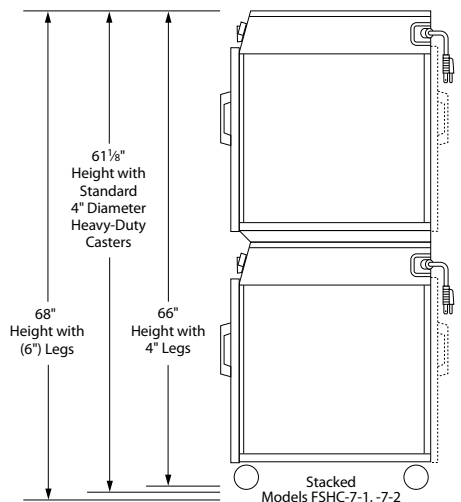
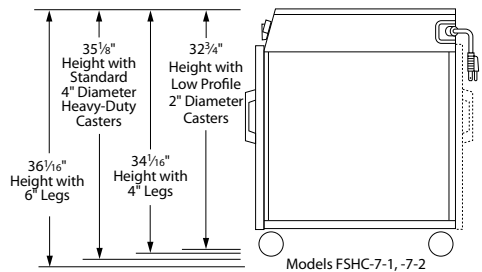
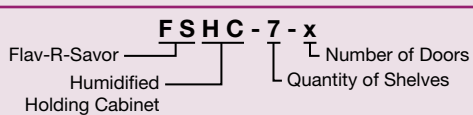



Flav-R-Savor® Tall Humidified Holding Cabinets

The expanded capacity of Hatco's Tall Humidified Cabinets offers flexibility – giving customers more variety of menu items, and holding larger quantities of proven favorites ahead of peak serving periods. The universal slides of the FSHC-17W models will hold 17 sheet pans or 34 steam table pans. FSHC-12W models will hold 12 sheet pans and 24 steam table pans.

- Electronic controls with digital readout temperature range of 80°-200°F with precise heat and humidity settings assure uniform heating throughout the cabinet
- Using the lower temperature range of 80°-100°F allows perfect temperature for proofing all types of bread
- Lexan or stainless steel doors, full height, half height and pass-through available
- All Stainless Steel interior and exterior
- Fully insulated doors, sidewalls, base and top assist in heat retention and quick recovery
- Field reversible, right- or left-hand hinged doors with magnetic latch and heavy-duty plated hinges
- Fully welded tubular frame assures integrity of unit in any working environment



FSHC-12W1
with optional
Stainless Steel door



FSHC-17W1

Quick-Ship Program Information Inside Back Cover

Holding Cabinets

TALL HUMIDIFIED HOLDING CABINETS

Model	Description	Dimensions W x D x H ‡	Voltage Single Phase	Watts	Amps	Plugs	Approx. Ship Weight	List Price
FSHC-12W1	Single Lexan® Door	26" x 34¾" x 57¾"	120 208-240	1650 1608-2133	13.8 7.7-8.9	NEMA 5-20P NEMA 6-15P	303 lbs.	\$18045
FSHC-12W2	2 Lexan® Doors – Pass-Through	26" x 35¾" x 57¾"	120 208-240	1650 1608-2133	13.8 7.7-8.9	NEMA 5-20P NEMA 6-15P	316 lbs.	21760
FSHC-17W1	Single Lexan® Door	26" x 34¾" x 73¾"	120 208-240	1650 1608-2133	13.8 7.7-8.9	NEMA 5-20P NEMA 6-15P	352 lbs.	18335
FSHC-17W1D	Single Opening w/ 2 Dutch Doors	26" x 34¾" x 73¾"	120 208-240	1650 1608-2133	13.8 7.7-8.9	NEMA 5-20P NEMA 6-15P	360 lbs.	19726
FSHC-17W2	2 Lexan® Doors – Pass-Through	26" x 35¾" x 73¾"	120 208-240	1650 1608-2133	13.8 7.7-8.9	NEMA 5-20P NEMA 6-15P	365 lbs.	21917
FSHC-17W2D	4 Dutch Doors – Pass-Through	26" x 35¾" x 73¾"	120 208-240	1650 1608-2133	13.8 7.7-8.9	NEMA 5-20P NEMA 6-15P	389 lbs.	24127

‡ Height includes standard casters.

All Tall Humidified Holding Cabinet Models Feature:

Cabinet Opening Dimensions: **FSHC-12W:** 22"W x 43½"H.
FSHC-17W: 22"W x 59¾"H.

Models Shipped with: 10' cord and plug, 5" casters, universal slides for 18" x 26" pans or 12" x 20" pans.

Pan Capacity – FSHC-12W: 12-sheet pan capacity on 3" centers, adjustable on 1½" centers, with 12 universal pan slides designed to accommodate up to 12 sheet or up to 24 steam table pans.

Pan Capacity – FSHC-17W: 17-sheet pan capacity on 3" centers, adjustable on 1½" centers, with 17 universal pan slides designed to accommodate up to 17 sheet or up to 34 steam table pans.

Water Reservoir Capacity for Humidity System: 2 gallons.

Cord Location: Recessed, facing controls, right-hand side panel, lower right corner.

OPTIONS AND ACCESSORIES – PAGE 196
WATER QUALITY REQUIREMENTS – PAGE 242

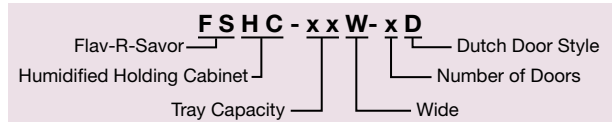



FSHC-17W1

OPTIONS (available at time of purchase only)

DELUXE	Deluxe Package (includes Flush Mount Handles and Full Perimeter Bumper)	\$1311
TRANS	Transport Package (includes Stand-Off Handles, Full Perimeter Bumper, Heavy-duty 5" x 2" Casters (2 swivel with wheel locks and 2 rigid), and Flush Mount Transport Latch)	2314
CORDWIND	Bracket for holding cord during transport (only available with Transport Package option for FSHC-12W and FSHC-17 models)	134
12W-SS-DOOR	Stainless Steel Door in lieu of Lexan® Door	No Charge
17W-SS-DOOR	Stainless Steel Door in lieu of Lexan® Door	No Charge
17WD-SS-DOOR	Stainless Steel Dutch Doors in lieu of Lexan® Dutch Doors (FSHC-17W models only)	No Charge

ACCESSORIES (available for purchase at any time)

17W-SLIDE	Extra Pan Slides (FSHC-12W and FSHC-17W)	pair \$238
------------------	--	-------------------



FOOD PANS AND TRIVETS – PAGE 240



Flav-R-Savor® Tall Non-Humidified Holding Cabinets

Be prepared to serve ready-to-go pizzas with Hatco's Flav-R-Savor® Tall Dry Holding Cabinets. An eight-shelf rack with 5" centers will hold a maximum of 16 boxed (18" Sq x 2⁵/₁₆"H maximum) or 8 bagged pizzas.

- Great for boxed or bagged carryout pizzas
- Tempered glass throughout for excellent visibility, improving product rotation
- Even, constant cabinet temperatures with no humidity
- Two, shatter-resistant, incandescent lights at the back top of the unit to illuminate product
- Units come with an eight-shelf rack, six of which are removable



PFST-2X with standard stainless steel 8-shelf rack



PFST-1XB with standard Glossy White 8-shelf rack

Holding Cabinets

TALL HOLDING CABINETS – NON-HUMIDIFIED

Model	Description	Dimensions W x D x H	Opening Dimensions W x H	Voltage	Watts	Plug	Approx. Ship Weight	List Price
Standard								
PFST-1X	1 Door	22 ⁷ / ₈ " x 25" x 57"	18 ³ / ₄ " x 40 ³ / ₈ "	120	1767	NEMA 5-20P	200 lbs.	\$11905
PFST-2X	2 Doors	22 ⁷ / ₈ " x 27 ¹ / ₄ " x 57"	18 ³ / ₄ " x 40 ³ / ₈ "	120	1767	NEMA 5-20P	207 lbs.	12530
With Base								
PFST-1XB	1 Door	24 ³ / ₄ " x 25 ¹ / ₂ " x 70"	18 ³ / ₄ " x 40 ³ / ₈ "	120	1767	NEMA 5-20P	258 lbs.	\$12346

All Tall Dry Holding Cabinet Models Feature:

Models Shipped with: PFST-1X, -2X: Stainless Steel body, an eight-shelf rack with 6 removable shelves in standard stainless steel, new latching handle, 5" locking casters, cord and plug.

PFST-1XB: Solid back panel, stainless steel inside, (with painted Glossy Gray on the outside), an eight-shelf rack with 6 removable shelves in standard Smooth White, front and side sign holders painted Glossy Gray with flip-up side for access to controls (signs not included), 11" high Designer Black base, latching handle, 4" locking casters, cord and plug.

Available Shelf Space: 18" square x 4⁵/₈" height.

Cord Location: Facing controls, left-hand side panel, bottom right corner.

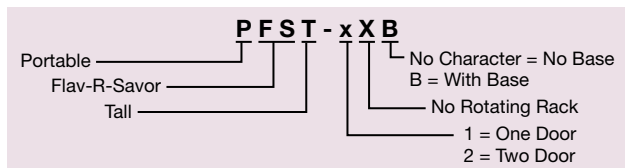

OPTIONS (available at time of purchase only)

Designer Color – Non-standard colors are non-returnable –
– Clear Anodized Aluminum Standard –
BLACK Black **\$748**

COLORS AND FINISHES – PAGE 241



Flav-R-Savor® Heated Air Curtain Cabinets

The patented Flav-R-Savor® Heated Air Curtain Cabinet effectively and safely holds hot food hot without the use of doors, allowing immediate access to product. Warm air at the front of the cabinet is forced downward, through the ducts above the opening, forming a “curtain” of heated air. A portion of the heated air is drawn toward the rear of the cabinet, warming each pan.

- Perfect for holding wrapped or sealed product like tortillas, burritos and ribs, as well as product on sheet pans like biscuits, hamburger patties and baked potatoes or fried foods in pans
- Available in 2-pan and 3-pan models, single opening or pass-through, with or without humidity
- The FS2HAC-15 holds 6, 1/3 size pans (pans not included)
- The 2-pan pass-through accommodates two full-size sheet pans or four half-size sheet pans, and the 4-pan unit accommodates four full-size sheet pans or eight half-size sheet pans
- FS2HAC-15 comes standard with a pan rack, removeable crumb tray, USB port and a touch screen control with temperature and timer display, and a 6' cord and plug



FSHACH-2 with accessory food pans



FS2HAC-15 with 1/3 size food pans (pans not included)



FS2HAC-2PT with accessory food pans

Holding Cabinets

HEATED AIR CURTAIN CABINETS

Model	Description	Dimensions (W x D x H)	Cabinet Opening Dimensions (W x H)	Voltage	Watts	Amps	Plugs	Approx. Ship Weight	List Price
FSHAC-2 †	2-Tier Warmer	20 ⁷ / ₈ " x 22 ⁷ / ₈ " x 18 ¹ / ₈ "	18 ¹ / ₄ " x 9 ⁵ / ₈ "	120	1850	15.4	NEMA 5-20P	102 lbs.	\$ 9579
FSHAC-2 †	2-Tier Warmer	20 ⁷ / ₈ " x 22 ⁷ / ₈ " x 18 ¹ / ₈ "	18 ¹ / ₄ " x 9 ⁵ / ₈ "	120/208	1877	9.0	NEMA L14-20	102 lbs.	9579
FSHAC-3 †	3-Tier Warmer	20 ⁷ / ₈ " x 22 ⁷ / ₈ " x 30 ¹ / ₂ "	18 ¹ / ₄ " x 18 ¹ / ₈ "	120/208	1877	9.0	NEMA L14-20	105 lbs.	10001
FS2HAC-15	Open Cavity Warmer	15 ¹ / ₂ " x 21 ¹ / ₄ " x 21 ³ / ₄ "	14 ³ / ₄ " x 13"	120	1105	9.2	NEMA 6-15P	83 lbs.	8927
FS2HAC-2PT †	2-Tier Pass-Through	24 ¹ / ₈ " x 39 ¹ / ₈ " x 18 ¹ / ₂ "	18 ¹ / ₁₆ " x 8 ⁵ / ₈ "	120/208 or 120/240	2589	10.8	NEMA L14-20	175 lbs.	14581
FS2HAC-4PT †	4-Tier Pass-Through	24 ¹ / ₈ " x 39 ¹ / ₈ " x 26 ¹ / ₂ "	18 ¹ / ₄ " x 16 ¹ / ₈ "	120/208 or 120/240	3389	14.2	NEMA L14-20	211 lbs.	15930

† Height includes 4" legs.

All Heated Air Curtain Cabinet Models Feature:

Cord Location: FSHAC-2, -3: Top of unit towards the back, middle.

FS2HAC-15: Top of unit towards the back, right side.

FS2HAC-2PT, -4PT: Top of unit towards the back, left side.

HEATED AIR CURTAIN CABINETS – HUMIDIFIED

Model	Description	Dimensions (W x D x H)	Cabinet Opening W x H	Voltage	Watts	Amps	Plugs	Approx. Ship Weight	List Price
FSHACH-2	2-Tier Warmer	20 ⁷ / ₈ " x 24 ³ / ₈ " x 18 ¹ / ₈ "	18 ¹ / ₄ " x 9 ⁵ / ₈ "	120/208	2950	14.2	NEMA L14-20P	100 lbs.	\$ 11186
FSHACH-3 †	3-Tier Warmer	20 ⁷ / ₈ " x 24 ³ / ₈ " x 30 ¹ / ₂ "	18 ¹ / ₄ " x 18 ¹ / ₈ "	120/208	2950	14.2	NEMA L14-20P	100 lbs.	11689
FSHACH-2PT †	2-Tier Pass-Through	24 ¹ / ₈ " x 35 ⁵ / ₈ " x 22"	18 ¹ / ₄ " x 9 ¹ / ₄ "	120/208	4952	23.8	NEMA L14-30P	150 lbs.	16382
FSHACH-2PT †	2-Tier Pass-Through	24 ¹ / ₈ " x 35 ⁵ / ₈ " x 22"	18 ¹ / ₄ " x 9 ¹ / ₄ "	208	4952	23.8	NEMA L6-30P	150 lbs.	16382

† Height includes 4" legs.

All Humidified Heated Air Curtain Cabinet Models Feature:

Models Shipped with: Auto-fill water reservoir and water filter. 4" legs also come standard (excluding FSHACH-2).

Water Tank Capacity for Humidity System: FSHACH-2, -3: 2¹/₄ gallons.

FSHACH-2PT: 3 gallons.

Cord Location: FSHACH-2, -3: Top of unit towards the back, middle.

FSHACH-2PT: Top of unit towards the back, left side.

FOOD PANS AND TRIVETS – PAGE 240

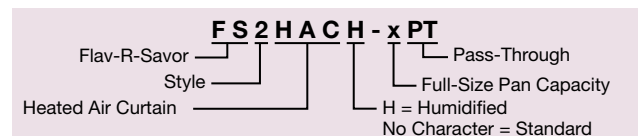
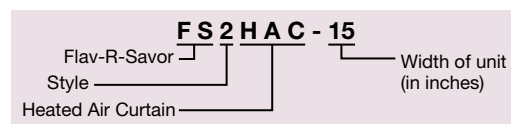



Plate Warmers

Hatco's Plate Warmers are designed to hold preheated serving plates where your customers can access them easily. Countertop or Built-In models available. Easy to load and easy to clean. Serving hot food on preheated plates will help extend the holding times of most foods, and adds to a better customer experience.

- Can hold 25 plates up to 12" in diameter
- A covered, digital temperature control with an adjustable range of 104° - 122°F
- Energy efficient LED lighting illuminates the interior from the top
- Available in Stainless Steel or *Designer Black* powdercoating
- Cabinet cutout dimensions are: 16⁵/₈" x 20¹/₈"



PWB-12
in standard
Stainless Steel



PWC-12
in optional *Designer Black*

Quick-Ship Program Information *Inside Back Cover*

PLATE WARMERS

Model	Item Number	Description	Dimensions (W x D x H ‡)	Opening Dimensions (W x H)	Voltage	Watts	Amps	Approx. Ship Weight	List Price
Countertop									
✓ PWC-12	PWC.12SS515	Countertop, Stainless Steel	16 ⁷ / ₈ " x 17 ³ / ₈ " x 22 ³ / ₈ "	12 ⁵ / ₈ " x 15 ³ / ₄ "	120	460	3.8	64 lbs.	\$3058
Built-In									
✓ PWB-12	PWB.12SS515	Built-In, Stainless Steel	17 ¹ / ₂ " x 17 ¹ / ₂ " x 21 ¹ / ₈ "	12 ³ / ₄ " x 15 ³ / ₄ "	120	460	3.8	49 lbs.	\$3382

‡ Height includes standard 1" legs.

All Plate Warmer Models Feature:

Models Shipped with:

PWC-12: Power On/Off switch, a detachable 6' power cord, a 3' jumper cord and a wall-mounting kit, NEMA 5-15P plug.

PWB-12: Power On/Off switch, a detachable 6' power cord and a 3' jumper cord, NEMA 5-15P plug.

Cabinet cut-out dimensions for **PWB-12:** 16³/₄" W x 20¹/₄" H.

Cord Location: back of unit, top left corner.

OPTIONS (available at time of purchase only)

Designer Color – Non-standard colors are non-returnable – Stainless Steel Standard – BLACK *Designer Black* **\$204**

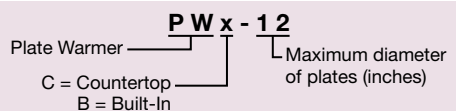

Holding Cabinets

Toasters





Pop-Up Toasters

Perfect for self-serve areas and light volume applications, the Hatco Pop-Up Toasters provide even golden toasting of a variety of bread products. The durable stainless steel housing contains four extra wide self-centering slots with individual toasting controls and removable crumb tray.

- Evenly toasts a variety of bread products including bagels, Texas toast, waffles and English muffins
- All models have four self-centering 1¼" wide slots
- A selector switch for single- or double-sided toasting (excluding TPT-120)
- Durable stainless steel construction
- Individual toasting controls
- Removable crumb trays for easy cleaning
- 6' cord with plug



TPT-120



TPT-208 Selector switch for single- or double-sided toasting (excluding TPT-120)

Quick-Ship Program Information *Inside Back Cover*

POP-UP TOASTERS

Model	Dimensions W x D x H	Voltage	kW	Plug	Approx. Ship Weight	List Price
✓ TPT-120	13½" x 12¾" x 8½"	120	1.4	NEMA 5-15P	14 lbs.	\$ 850
✓ TPT-208	13¾" x 12¾" x 8½"	208	2.7	NEMA 6-20P	16 lbs.	1466
✓ TPT-240	13¾" x 12¾" x 8½"	240	2.7	NEMA 6-15P	16 lbs.	1466

All Pop-Up Toaster Models Feature:

Slot Opening: 1¼"W x 5½"D.

Cord Location: 6' cord – back of unit, lower center.

Pop-Up Toasters can be shipped Fed-Ex Ground or United Parcel Service.

TOASTER AMP RATINGS

Model	120V/1 Ø Amps	208V/1 Ø Amps	240V/1 Ø Amps
TPT-120	12.0	–	–
TPT-208	–	13.0	–
TPT-240	–	–	11.3

OPTIONS (available at time of purchase only)

Designer Color – Non-standard colors are non-returnable – Stainless Steel Standard –		
BBLACK	Bold Black (TPT-120 only)	\$202
RRED	Radiant Red (TPT-120 only)	202

COLORS AND FINISHES – PAGE 241



TPT-120 in optional Bold Black



TPT-120 in optional Radiant Red

Toaster Pop-Up Type **TPT - xxx** Voltage

Toasters



Toast-Qwik® Conveyor Toasters

Flexibility and performance are yours with the Hatco Toast-Qwik® conveyor toasters. These toasters produce perfect golden toasting, from 300 to 1800 slices per hour. The power save mode conserves energy during non-peak serving times.

- Instant and precise adjustment of toast color with electronic infinite controls that regulate top and bottom heat
- Patented ColorGuard sensing system assures toast uniformity (excludes TQ-10)
- Opening height for H and HBA models is 3", for all other models the opening height is 2"
- Insulation and an interior fan provide cool surface temperatures
- Efficient design of front or rear discharge allows unit to be placed where it is most convenient – for sending product to the operator side or to the customer/server side
- TQ-1800 Series are 3-slice wide
- BA models toast one side only and are for bagels and buns, cut side up



TQ-10



TQ-800HBA

Quick-Ship Program Information *Inside Back Cover*

HORIZONTAL CONVEYOR TOASTERS

Model	Dimensions (W x D x H) <i>Height includes legs</i>	Opening Dimensions (W x H)	Voltage 60Hz	kW	Plug	Capacity/ Minute [‡]	Approx. Ship Weight	List Price
✓ TQ-10	14½" x 17¾" x 13¾"	10¾" x 2"	120	1.8	NEMA 5-20P	5 slices	42 lbs.	\$2904
✓ TQ-10	14½" x 17¾" x 13¾"	10¾" x 2"	208, 240	1.8	NEMA 6-15P	5 slices	42 lbs.	2904

HORIZONTAL CONVEYOR TOASTERS

Model	Dimensions W x D x H ‡	Opening Dimensions (W x H)	Voltage 60Hz	kW	Plug	Capacity/ Minute [‡]	Approx. Ship Weight	List Price
✓ TQ-400	14½" x 17¾" x 14⅞"	10¼" x 2"	120	1.8	NEMA 5-20P	6 slices	46 lbs.	\$4532
✓ TQ-400	14½" x 17¾" x 14⅞"	10¼" x 2"	208, 240	2.2	NEMA 6-15P	6 slices	46 lbs.	4532
TQ-400BA [▲]	14½" x 17¾" x 14⅞"	10¼" x 2"	120	1.8	NEMA 5-20P	6 slices	46 lbs.	4532
TQ-400BA [▲]	14½" x 17¾" x 14⅞"	10¼" x 2"	208, 240	1.9	NEMA 6-15P	6 slices	46 lbs.	4532
TQ-400H	14½" x 17¾" x 15⅞"	10¼" x 3"	208, 240	2.2	NEMA 6-15P	6 slices	46 lbs.	4532
✓ TQ-800	14½" x 22¾" x 16⅞"	10⅞" x 2"	208	3.3	NEMA 6-20P	14 slices	62 lbs.	5167
TQ-800	14½" x 22¾" x 16⅞"	10⅞" x 2"	240	3.3	NEMA 6-20P	14 slices	62 lbs.	5167
TQ-800BA [▲]	14½" x 22¾" x 16⅞"	10⅞" x 2"	208	3.3	NEMA 6-20P	14 slices	62 lbs.	5167
TQ-800BA [▲]	14½" x 22¾" x 16⅞"	10⅞" x 2"	240	3.3	NEMA 6-20P	14 slices	62 lbs.	5167
✓ TQ-800H	14½" x 22¾" x 16⅞"	10⅞" x 3"	208	3.3	NEMA 6-20P	14 slices	62 lbs.	5167
TQ-800H	14½" x 22¾" x 16⅞"	10⅞" x 3"	240	3.3	NEMA 6-20P	14 slices	62 lbs.	5167
✓ TQ-800HBA [▲]	14½" x 22¾" x 16⅞"	10⅞" x 3"	208	3.3	NEMA 6-20P	13 slices	62 lbs.	5167
TQ-800HBA [▲]	14½" x 22¾" x 16⅞"	10⅞" x 3"	240	3.3	NEMA 6-20P	13 slices	62 lbs.	5167

Toasts Three Slices Wide

TQ-1800	18½" x 22¾" x 16⅞"	14⅞" x 2"	208, 240	4.4	NEMA 6-30P	30 slices	73 lbs.	\$6435
TQ-1800BA [▲]	18½" x 22¾" x 16⅞"	14⅞" x 2"	208, 240	4.6	NEMA 6-30P	30 slices	73 lbs.	6435
TQ-1800H	18½" x 22¾" x 16⅞"	14⅞" x 3"	208, 240	4.7	NEMA 6-30P	30 slices	73 lbs.	6435
TQ-1800HBA [▲]	18½" x 22¾" x 16⅞"	14⅞" x 3"	208, 240	4.6	NEMA 6-30P	30 slices	73 lbs.	6435

‡ Toasting capacity may vary by product. Toasting of coated products not recommended.

‡ Height includes legs. TQ-400 and TQ-400BA, add 2½" to depth if using tray extension in rear. TQ-800, TQ-800BA, TQ-800H, TQ-800HBA, TQ-1800, TQ-1800BA, TQ-1800H and TQ-1800HBA, add 6½" to depth if using tray extension in rear.

▲ BA models toast one side only and are for bagels and buns, cut side up.

All Conveyor Toaster Models Feature:

Cord Location: 6' cord – back of unit, lower right corner.

Toast-Qwik Toasters can be shipped Fed-Ex Ground or United Parcel Service.

OPTIONS AND ACCESSORIES – PAGE 203

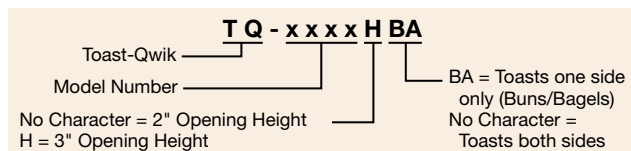



TQ-800H Toast Qwik®
Horizontal Conveyor Toaster

OPTIONS (available at time of purchase only, excludes TQ-10)

TQ-PWR-A Automatic Power Save Mode (switches to Power Save Mode after 30 minutes of inactivity) **No Charge**

ACCESSORIES (available for purchase at any time)

TQRAMP Additional Extended Feed Guide adds 3" (not available on TQ-10 or TQ-1800 Series) **\$205**

TQ2-SECURITY Control Cover and Bracket (not available on TQ-1800 series) **189**



TQ-800 with **TQ2-SECURITY** accessory security control cover

Toasters

TQ TOASTER AMP RATINGS

Model	120V/1 Ø	208V/1 Ø	240V/1 Ø
TQ-10	15.0	8.8	7.6
TQ-400	14.9	10.7	9.3
TQ-400BA	14.8	9.0	7.8
TQ-400H		10.3	9.3
TQ-800		16.0	13.9
TQ-800BA		15.8	13.7
TQ-800H		16.0	13.9
TQ-800HBA		15.8	13.7
TQ-1800		21.4	18.5
TQ-1800H		22.4	19.4
TQ-1800BA		22.0	19.1
TQ-1800HBA		22.0	19.1



Toast-Qwik® Conveyor Toasters

Hatco's next generation of Toast-Qwik® Toasters have been designed to provide a great look, easy to use touchscreen controller (excluding TQ3-10, -20 and -20H) and increased production capabilities. They continue to provide the best reliability, flexibility and value of any conveyor toaster available!

- Patented ColorGuard Sensing System which continually monitors and adjusts the chamber to ensure consistent toast results - even in your busiest periods
- The TQ3-10 features an Air Intake Filter screen on the front of the unit, while the rest of the line feature a removable bottom screen. Both versions are removable for easy cleaning
- Power Save mode activates manually by pressing the Power Save Button (green leaf symbol), which reduces power by 50%
- Crumb tray is removable for easy cleaning
- Up to 12 programmable settings for precise and instant product changes (excludes TQ3-10, -20 and -20H)
- USB port for software updates (excludes TQ3-10, -20 and -20H)
- 2" high opening standard - 3" high opening available on the TQ3-20H, -500H, -900H and -2000H models for thicker bread products



TQ3-2000
in optional
Stainless Steel



TQ3-500 in
optional *Designer*
Warm Red



TQ3-20H
in standard
Designer Black



TQ3-10
available in
Designer Black only

Quick-Ship Program Information Inside Back Cover

HORIZONTAL CONVEYOR TOASTERS

Model	Opening Dimensions (W x H)	Dimensions (W x D x H) Height includes legs	Voltage 50/60Hz	Watts	Amps	Plug	Approx. Ship Weight	List Price
✓ TQ3-10*	10 ³ / ₈ " x 2"	14 ¹ / ₂ " x 21 ³ / ₁₆ " x 16 ³ / ₁₆ "	120	1780	14.8	NEMA 5-20P	54 lbs.	\$2364
✓ TQ3-10	10 ³ / ₈ " x 2"	14 ¹ / ₂ " x 21 ³ / ₁₆ " x 16 ³ / ₁₆ "	208 or 240	1780	8.6 or 7.4	NEMA 6-15P	54 lbs.	2364
TQ3-20	10 ³ / ₈ " x 2"	14 ³ / ₈ " x 20 ¹ / ₁₆ " x 17 ⁹ / ₁₆ "	208	2470	11.9	NEMA 6-15P	54 lbs.	6234
TQ3-20	10 ³ / ₈ " x 2"	14 ³ / ₈ " x 20 ¹ / ₁₆ " x 17 ⁹ / ₁₆ "	240	2470	10.3	NEMA 6-15P	54 lbs.	6234
TQ3-20H	10 ³ / ₈ " x 3"	14 ³ / ₈ " x 20 ¹ / ₁₆ " x 17 ⁹ / ₁₆ "	208	2620	12.6	NEMA 6-20P	54 lbs.	6291
TQ3-20H	10 ³ / ₈ " x 3"	14 ³ / ₈ " x 20 ¹ / ₁₆ " x 17 ⁹ / ₁₆ "	240	2620	10.9	NEMA 6-15P	54 lbs.	6291

HORIZONTAL CONVEYOR TOASTERS

Model	Opening Dimensions (W x H)	Dimensions (W x D x H) Height includes legs	Voltage 50/60Hz	Watts	Amps	Plug	Approx. Ship Weight	List Price
✓ TQ3-400 [□]	10 ³ / ₈ " x 2"	14 ³ / ₄ " x 20 ⁵ / ₈ " x 17 ¹ / ₈ "	120	1780	14.8	NEMA 5-20P	48 lbs.	\$4419
TQ3-500	10 ³ / ₈ " x 2"	14 ³ / ₄ " x 20 ⁵ / ₈ " x 17 ¹ / ₈ "	208 or 240	2220	10.7 or 9.3	NEMA 6-15P	54 lbs.	4709
TQ3-500H	10 ³ / ₈ " x 3"	14 ³ / ₄ " x 20 ⁵ / ₈ " x 17 ¹ / ₈ "	208 or 240	2220	10.7 or 9.3	NEMA 6-15P	54 lbs.	4709
✓ TQ3-900	10 ³ / ₈ " x 2"	14 ³ / ₄ " x 20 ⁵ / ₈ " x 17 ¹ / ₈ "	208 or 240	3020	14.5 or 12.6	NEMA 6-20P	50 lbs.	5030
✓ TQ3-900H	10 ³ / ₈ " x 3"	14 ³ / ₄ " x 20 ⁵ / ₈ " x 17 ¹ / ₈ "	208 or 240	3020	14.5 or 12.6	NEMA 6-20P	55 lbs.	5030
Toasts Three Slices Wide								
TQ3-2000	14 ¹ / ₈ " x 2"	18 ³ / ₄ " x 23 ³ / ₈ " x 17 ¹ / ₈ "	208 or 240	4020	19.3 or 16.8	NEMA 6-30P	67 lbs.	\$6337
TQ3-2000H	14 ¹ / ₈ " x 3"	18 ¹ / ₂ " x 22 ³ / ₄ " x 17 ¹ / ₈ "	208 or 240	4020	19.3 or 16.8	NEMA 6-30P	67 lbs.	6337

□ TQ3-400 ships with a loose aluminum toast tray.

All Horizontal Conveyor Toaster Models Feature:
Cord Location: 6' cord – back of unit, lower right corner.

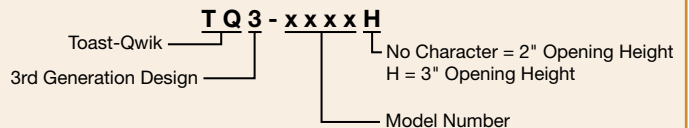

OPTIONS (available at time of purchase only)

Designer Colors – Non-standard colors are non-returnable – Designer Black Standard –		
SS	Stainless Steel (excluding TQ3-10)	\$394
WRED	Designer Warm Red (excluding TQ3-10)	No Charge
TQ3-30CORD	NEMA 6-30P cord in lieu of standard cord (on TQ3-500 and -900 series only)	\$147
SSINSERT	Stainless Steel toast tray insert (on TQ3-500 and -900 series only)	76
TQ3-RAMP	Extended feed ramp in lieu of existing ramp - adds 3" (excludes TQ3-10 and -400 models)	202
TQ3-RAMP-XL	XL extended feed ramp in lieu of existing ramp - adds 9" (on TQ3-500 and -900 models only)	76

COLORS AND FINISHES – PAGE 241



Intelligent Toast-Qwik®

Hatco's Intelligent Toast-Qwik® allows the operator to toast multiple products at the touch of the button, changing easily from bagels to croissants to Texas toast to hash browns, as well as melting cheese and finishing smaller food products. The unit can easily take the place of the current toasting platform and add versatility and future menu expansion, along with energy efficiency and cost savings.

- The conveyor toaster can operate in three different modes:
 - ~ Continuous Through Put
 - ~ In and Reverses Out Mode
 - ~ In, Pause, then Continues Through
- USB port located on the front allows for easy transfer of information, such as program changes and product usage information
- The ability to program up to twenty product settings
- Hatco's patented ColorGuard Sensing System monitors and adjusts conveyor

speed and temperature during high usage periods to ensure toast color uniformity

- Using Hatco's Spot-On® Technology, the toaster senses when product is placed on the conveyor and activates the unit
- Easy to clean, with removable crumb tray and collector ramp. There is minimal operator maintenance required, with self-cleaning elements and no maintenance motor and conveyor drives



ITQ-875-1C



ITQ-1000-1C



ITQ-1750-2C

HORIZONTAL CONVEYOR TOASTERS

Model	Voltage	Dimensions W x D x H	Watts	Amps	Capacity/ Minute [□]	Plug	Approx. Ship Weight	List Price
ITQ-875-1C	208	14 ⁵ / ₈ " x 28 ³ / ₄ " x 16 ⁵ / ₈ "	2700	13.0	15	NEMA 6-20P	86 lbs.	\$10227
ITQ-875-1C	240	14 ⁵ / ₈ " x 28 ³ / ₄ " x 16 ⁵ / ₈ "	2700	11.3	15	NEMA 6-20P	86 lbs.	10227
ITQ-1000-1C [✓]	208-240	17 ⁵ / ₈ " x 28 ⁵ / ₈ " x 18"	3230-4300	15.5-17.9	17	NEMA 6-30P	89 lbs.	10448
ITQ-1750-2C	208	20 ¹ / ₄ " x 28 ³ / ₄ " x 18 ¹ / ₂ "	4960	23.8	30	NEMA 6-30P	106 lbs.	13930
ITQ-1750-2C	240	20 ¹ / ₄ " x 28 ³ / ₄ " x 18 ¹ / ₂ "	4960	20.7	30	NEMA 6-30P	106 lbs.	13930

□ Toasting capacity may vary by product. Toasting of coated products not recommended.

✓ Unit is designed to operate on supply voltages between 208V and 240V.

All Horizontal Conveyor Toaster Models Feature:

Opening Dimensions: ITQ-875-1C: 5⁵/₈"W x 2¹/₈"H.

ITQ-1000-1C: 9⁵/₈"W x 2"H.

ITQ-1750-2C: Two openings at 5⁵/₈"W x 2¹/₄"H.

Cord Location: 6' cord – back of unit, lower left center.

OPTIONS (available at time of purchase only)

ITQ-L6-20	NEMA L6-20P Locking Cap in lieu of NEMA 6-20P	\$307
ITQ-L6-30	NEMA L6-30P Locking Cap in lieu of NEMA 6-30P	67



ITQ2C-PAD
Accessory

ACCESSORIES (available for purchase at any time)

Paddle, with high temp, non-stick coating –

ITQ1C-PAD	9" wide Food Paddle for ITQ-1000-1C model only	\$317
ITQ2C-PAD	5.7" wide Food Paddle for ITQ-875-1C and ITQ-1750-2C models only	242
ITQ2CFEED175	Feed Ramp for ITQ-1750-2C only (sold as single ramp only)	147

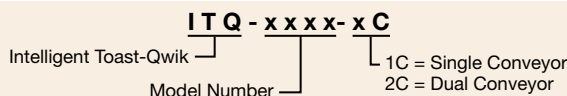



Toast King® Conveyor Toasters

Designed for mid-to high-volume and constant flow applications, Hatco's proven reliability and performance makes the Toast King® Toasters the workhorse of your operation. These toasters use conveyor speed, not temperature, to determine toast color.

- Toasts a variety of bread products
- Stainless steel construction for years of trouble-free service
- Power-saving thermostat for energy savings during non-peak times
- Manual advance, speed control and cord with plug included
- Fully insulated for cooler operation
- Multiple metal sheathed toasting elements
- Toast storage area keeps bread warm and dry
- Capacity of 720-1500 slices per hour
- Three basket access for fast loading
- Top venting keeps heat away from the operator



TK-135B



TK-72

Quick-Ship Program Information *Inside Back Cover*

VERTICAL CONVEYOR TOASTERS

Model	Description	Dimensions [↔] W x D x H	Basket Size W x H	Voltage Single Phase	Hz	Capacity/ Minute [⊥]	Plug	Approx. Ship Weight	List Price
TK-72	Bread and Buns	18¼" x 17½" x 33¼"	10" x 4⅝"	208 or 240	60	12 slices	NEMA 6-30P	73 lbs.	\$8055
TK-100	Bread and Buns	22¾" x 17½" x 33¼"	14½" x 4⅝"	208 or 240	60	16 slices	NEMA 6-30P	88 lbs.	8617
TK-135B	Buns Only	22¾" x 17½" x 33¼"	14½" x 4⅝"	208 or 240	60	22 slices	NEMA 6-30P	88 lbs.	8620
TK-155B	3-Part Buns	22¾" x 17½" x 33¼"	14½" x 4⅝"	208 or 240	60	25 slices	NEMA 6-30P	88 lbs.	9088

[↔] Width included ¾" for manual advance knob. Depth includes tray extension of 3½".
[⊥] Toasting capacity may vary by product. Toasting of coated products not recommended.

All Vertical Conveyor Toaster Models Feature:

Max. Product Thickness: 1¼".

Cord Location: 4' cord – back of unit, lower left side.

Toasters

OPTIONS (available at time of purchase only)

TK-SECURITY Control Cover, Bracket, Mounting Hardware and Fuse Cover **\$375**

ACCESSORIES (available for purchase at any time)

4" LEGS 4" Adjustable Legs (4) **\$98**

TK TOASTER AMP RATINGS

Model	208V/1 Ø	240V/1 Ø	kW
	Amps	Amps	
TK-72	19.4	16.8	4.0
TK-100	24.0	21.0	5.0
TK-135B	20.9	18.1	4.3
TK-155B	24.1	20.9	5.0

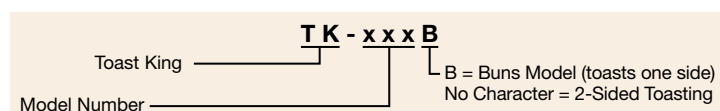

Induction Ranges & Warmers





Boxer® Countertop Induction Ranges

Hatco's Boxer® Countertop Induction Ranges are simple-to-operate, no-frills cooktops built to handle the rigors and performance of commercial foodservice use.

- Designed with heavy gauge stainless steel housing and side impact protection
- Large adaptive control knob easily adjusts based on user input for easy setting of time and temperature, while a digital display instantly advises of precise power and time control
- Include safety and convenience features, such as an energy-saving automatic shut-off to prevent overheating, compatible pan detection and an ultra-quiet cooling fan
- Glass-ceramic top is durable, easy to clean and fully sealed with conformal-coated boards for extra protection against grease or moisture

IRNG-BXC1-14



Close up of patterned black glass-ceramic top – helps prevent noticeable scratches due to heavy use



BOXER COUNTERTOP INDUCTION RANGES

Model	Item No.	Dimensions W x D x H	Voltage Single Phase	Watts	Approx. Ship Weight†	List Price
IRNG-BXC1-14	IRNGBXC114515	12 ⁷ / ₈ " x 17 ⁵ / ₈ " x 4"	120	1440	17 lbs.	\$1960

All Boxer Countertop Induction Range Models Feature:

Models Shipped with: A 71" cord and plug.
Cord Location: Rear right bottom base corner.

Induction Ranges
& Warmers

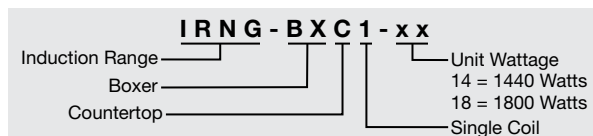



Rapide Cuisine® Countertop Heavy-Duty Induction Ranges

Hatco's Rapide Cuisine® Countertop Heavy-Duty Induction Ranges are simple to operate and feature extra side protection and a scratch-hiding cooktop surface to withstand more demanding cooking environments.

- Large adaptive control knob easily adjusts based on user input for easy setting of time and temperature, while high-resolution TFT display instantly advises of precise power and time control
- Include safety and convenience features, such as an energy-saving automatic shut-off to prevent overheating
- Magnetic Power System (MPS) delivers the highest power in its class, while Pan Sense Technology (PST) activates the unit only when a compatible pan is detected on top
- Durable patterned glass-ceramic top is easy to clean and is fully sealed with conformal-coated boards for extra protection against grease or moisture

Close up of patterned black glass-ceramic top – helps prevent noticeable scratches due to heavy use



IRNG-HC1-14

COUNTERTOP HEAVY-DUTY INDUCTION RANGES

Model	Item No.	Dimensions W x D x H	Voltage Single Phase	Watts	Approx. Ship Weight	List Price
IRNG-HC1-14	IRNGHC114SB515	13" x 17" x 3 3/8"	120	1440	17 lbs.	\$2470

All Countertop Heavy-Duty Induction Range Models Feature:

Models Shipped with: A 71" cord and plug.

Cord Location: Rear left bottom base corner.

Induction Ranges
& Warmers

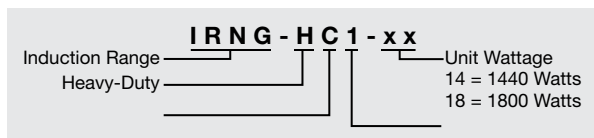



Rapide Cuisine® Induction Ranges

Hatco's Rapide Cuisine® Induction Ranges are unlike any other induction units. Built for the demands of commercial foodservice use, its Magnetic Power System (MPS) delivers the highest power in its class.

- Feature programmable mode to create preset programs for consistent cooking cycles and quality product
- High-resolution TFT display instantly advises of precise power, temperature and time control
- Pan Sense Technology (PST) activates the unit only when a compatible pan is detected on top
- Built-in USB ports allow operators to download recipes and easily upload them to other units, ensuring consistent cooking performance across multiple ranges
- Include safety and convenience features, such as an energy-saving automatic shut-off to prevent overheating
- Fully sealed top with conformal-coated boards for extra protection against grease or moisture
- Drop-in models can be mounted flush or near flush to the countertop with an optional trim ring



IRNG-PC1-14 shown in the standard finishes



COUNTERTOP INDUCTION RANGES

Model	Item No.	Dimensions W x D x H	Top Housing	Bottom Housing	Voltage Single Phase	Watts	Approx. Ship Weight	List Price
IRNG-PC1-14	IRNGPC114SB515	13" x 17" x 3 3/8"	Stainless Steel (Standard)	Bold Black (Standard)	120	1440	17 lbs.	\$2269

All Countertop Induction Range Models Feature:
Models Shipped with: A 71" cord and plug and a food temperature probe.
Cord Location: Rear left bottom base corner.

Quick-Ship Program Information Inside Back Cover

DROP-IN INDUCTION RANGES

Model	Item No.	Dimensions W x D x H	Voltage Single Phase	Watts	Approx. Ship Weight	List Price
✓ IRNG-PB1-14	IRNGPB114515	13 1/2" x 14 1/2" x 3 1/2"	120	1440	17 lbs.	\$2470
✓ IRNG-PB1-18	IRNGPB118520	13 1/2" x 14 1/2" x 3 1/2"	120	1800	17 lbs.	2470

All Drop-In Induction Range Models Feature:
Control Panel: 12"W x 4 1/2"H.
Models Shipped with: A 51" cable from the base unit to the control panel, a 71" cord and plug, and a food temperature probe.
Cord Location: Rear left bottom base corner.

ACCESSORY (available at any time)

Holds unit nearly flush on the counter (for use where chair-step routing of a countertop material is not possible, but a flush mount look is desired) –

Trim Ring in Stainless Steel for IRNG-PB1-14 or -18 (holds unit nearly flush on a stainless steel or any similar material countertop) **\$101**

COLORS AND FINISHES – PAGE 241

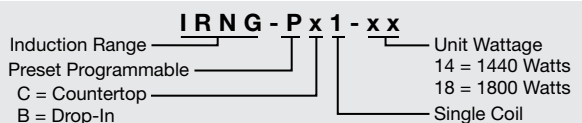

Induction Ranges & Warmers



Rapide Cuisine® High-Powered/Heavy-Duty Induction Ranges

Hatco's Rapide Cuisine® High-Powered/Heavy-Duty Induction ranges offer industry-leading features and true back-of-the-house power, with heavy gauge stainless housing, side impact protection and a scratch-hiding cooktop surface.

- Feature easy-to-use, color-coded selectable functions and User Programmable Presets (UPP) with a 3-stage programming mode for the operator to create preset programs
- Include a food temperature probe and four temperature sensors for more accurate control and cooking
- Withstand high ambient kitchen temperatures up to 124°F – the highest tolerance on the market
- Built-in USB ports allow operators to download recipes and easily upload them to other units, ensuring consistent cooking performance across multiple ranges
- High-resolution TFT display instantly advises of precise power, temperature and time control
- Fully-sealed top with conformal-coated boards adds extra protection against grease or moisture
- Culinary equivalent of up to 31,000 BTUs gas per burner
- Drop-in models can be mounted flush or near flush to the countertop with an optional trim ring

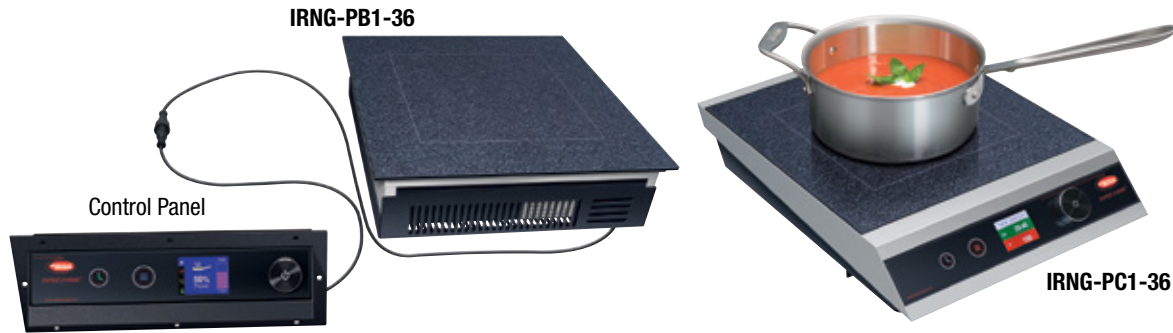

Quick-Ship Program Information *Inside Back Cover*

COUNTERTOP HIGH-POWERED/HEAVY-DUTY INDUCTION RANGES

Model	Item No.	Dimensions W x D x H	Voltage Single Phase	Watts	Approx. Ship Weight	List Price
✓ IRNG-PC1-36	IRNGPC136SB620	13 ⁷ / ₈ " x 18 ⁵ / ₈ " x 3 ³ / ₄ "	208-240	3120-3600	22 lbs.	\$3605

All Countertop High-Powered/Heavy-Duty Induction Range Models Feature:

Models Shipped with: A 71" cord and plug and a food temperature probe.

Cord Location: Rear left bottom base corner.

Quick-Ship Program Information *Inside Back Cover*

DROP-IN HIGH-POWERED/HEAVY-DUTY INDUCTION RANGES

Model	Item No.	Dimensions W x D x H	Voltage Single Phase	Watts	Approx. Ship Weight	List Price
✓ IRNG-PB1-36	IRNGPB136SB620	13 ¹ / ₂ " x 14 ¹ / ₂ " x 3 ⁵ / ₈ "	208-240	3120-3600	20 lbs.	\$3803

All Drop-In High-Powered/Heavy-Duty Induction Range Models Feature:

Models Shipped with: A 51" cable from the base unit to the control panel, a 71" cord and plug, and a food temperature probe.

Cord Location: Rear right bottom base corner.

ACCESSORY (available for purchase at any time)

Holds unit nearly flush on the counter (for use where chair-step routing of a countertop material is not possible, but a flush mount look is desired) –

Trim Ring in Stainless Steel (holds unit nearly

TRIM-PB1-36 flush on a stainless steel or any similar material countertop) **\$101**

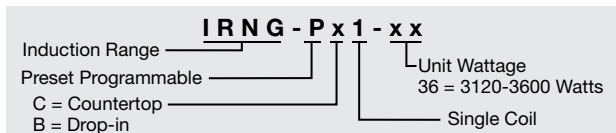

Induction Ranges & Warmers



Rapide Cuisine® High-Powered/ Heavy-Duty Dual Induction Ranges

Hatco's Rapide Cuisine® High-Powered/Heavy-Duty Dual Induction ranges offer industry-leading features and true back-of-the-house power. These units feature two hobs with a front-to-back or side-to-side configuration to optimize your countertop footprint.

- Feature User Programmable Presets (UPP) with a 3-stage programming mode for the operator to create preset programs
- Include a food temperature dual probe and four temperature sensors per hob for more accurate control and cooking
- Heavy gauge stainless steel housing, side impact protection and a scratch-hiding cooktop surface
- Withstand high ambient kitchen temperatures up to 124°F – the highest tolerance on the market
- Built-in USB ports allow operators to download recipes and easily upload them to other units, ensuring consistent cooking performance across multiple ranges
- Fully-sealed top with conformal-coated boards adds extra protection against grease or moisture
- Culinary equivalent of up to 31,000 BTUs gas per burner
- -IA models feature Optimal Power Control (OPC), which delivers higher power from lower amperage circuits, to boost power by 25% when needed and allows for a double unit on a single unit circuit•

IRNG-PC2S-36 Side-to-side configuration shown



Quick-Ship Program Information Inside Back Cover

COUNTERTOP HIGH-POWERED/HEAVY-DUTY DUAL INDUCTION RANGES

Model	Item No.	Configuration	Dimensions W x D x H	Voltage Single Phase	Watts (per coil)	Total Power (watts)	Approx. Ship Weight	List Price
Front to Back Ranges								
✓ IRNG-PC2F-29	IRNGPC2F29630	Front to Back	14" x 29 11/16" x 5 1/4"	208-240	2496-2880	4992-5760	41 lbs.	\$7055
✓ IRNG-PC2F-36	IRNGPC2F36650	Front to Back	14" x 29 11/16" x 5 1/4"	208-240	3120-3600	6240-7200	41 lbs.	7835
Front to Back – Input Averaging Ranges								
✓ IRNG-PC2F-24-IA	IRNGPC2F24IA620	Front to Back	14" x 29 11/16" x 5 1/4"	208-240	1803-2400	3606-4800	41 lbs.	\$7409
✓ IRNG-PC2F-36-IA	IRNGPC2F36IA630	Front to Back	14" x 29 11/16" x 5 1/4"	208-240	3120-3600	6240-7200	41 lbs.	8227
Side to Side Ranges								
✓ IRNG-PC2S-29	IRNGPC2S29630	Side to Side	24 7/8" x 19" x 4 1/2"	208-240	2496-2880	4992-5760	41 lbs.	\$7055
✓ IRNG-PC2S-36	IRNGPC2S36650	Side to Side	24 7/8" x 19" x 4 1/2"	208-240	3120-3600	6240-7200	41 lbs.	7835
Side to Side Ranges – Input Averaging Range								
✓ IRNG-PC2S-24-IA	IRNGPC2S24IA620	Side to Side	24 7/8" x 19" x 4 1/2"	208-240	1803-2400	3606-4800	41 lbs.	\$7409
✓ IRNG-PC2S-36-IA	IRNGPC2S36IA630	Side to Side	24 7/8" x 19" x 4 1/2"	208-240	3120-3600	6240-7200	41 lbs.	8227

All Countertop High-Powered/Heavy-Duty Dual Induction Range Models Feature:
Models Shipped with: A 71" cord and plug and two food temperature probes. Cord Location: Rear left bottom base corner.

DROP-IN HIGH-POWERED/HEAVY-DUTY DUAL INDUCTION RANGES

Model	Item No.	Dimensions W x D x H	Voltage Single Phase	Watts (per coil)	Total Power (watts)	Approx. Ship Weight	List Price
✓ IRNG-PB2-29	IRNGPB229630	13 13/16" x 27 9/16" x 6 1/4"	208/240	2496/2880	4992/5760	42 lbs.	\$6617
✓ IRNG-PB2-36	IRNGPB236650	13 13/16" x 27 9/16" x 6 1/4"	208/240	3120/3600	6240/7200	42 lbs.	6939
Input Averaging (IA) Models							
✓ IRNG-PB2-24-IA	IRNGPB224IA620	13 13/16" x 27 9/16" x 6 1/4"	208/240	1803/2400	3606/4800	42 lbs.	\$6949
✓ IRNG-PB2-36-IA	IRNGPB236IA630	13 13/16" x 27 9/16" x 6 1/4"	208/240	3120/3600	6240/7200	42 lbs.	7289

All Drop-In High-Powered/Heavy-Duty Dual Induction Range Models Feature:
Models Shipped with: Two 27 1/2" cables from the base to the control, a 71" cord and plug, and two food temperature probes. Cord Location: Rear left bottom base corner.

ACCESSORIES (available for purchase at any time)

TRIM-PB2-SS Trim Ring in Stainless Steel (holds unit nearly flush on a stainless steel or any similar material countertop) \$197

Induction Ranges & Warmers

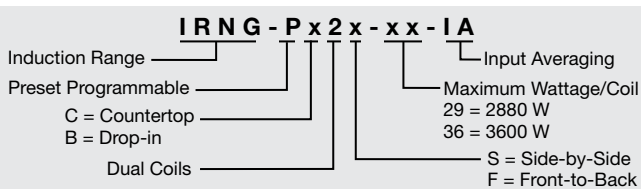



Palletti® Induction Warmers

Hatco's Palletti® Induction Warmers offer a safe, efficient and attractive way to safely keep food hot, with five precise low- to high-power warming levels that suit a wide variety of food types and volumes.



IWRM-C1-1317-06

- The power levels are memory retentive, so the last setting will resume when the unit is powered back on.
- Designed with no open flames, operates quietly, and includes an automatic shut-off to prevent overheating and enhance safety.
- Glass ceramic-top is extremely durable and easy to clean
- Pan Sense Technology (PST) activates the unit only when a suitable pan is placed on the trivet.
- Daisy chain models are low wattage allows multiple units to be interconnected to one electrical outlet, guaranteeing great energy efficiency and simple cord management. (Maximum four [4] connected units.)
- Drop-in models are available with black or white glass-ceramic tops and can be mounted flush or near flush to the countertop with an optional trim ring. Once installed, the glass-ceramic top does not need to be removed for servicing; the lower housing can be removed separately

Quick-Ship Program Information *Inside Back Cover*

COUNTERTOP INDUCTION WARMERS

Model	Item No.	Dimensions W x D x H	Voltage Single Phase	Watts	Approx. Ship Weight	List Price
IWRM-C1-1317-06	IWRMC113176B515	13" x 17¾" x 2¼"	120	600	12 lbs.	\$1763

All Countertop Induction Warmer Models Feature:
Models Shipped with: A 71" cord and plug.
Cord Location: Rear right bottom base corner.



Quick-Ship Program Information *Inside Back Cover*

DAISY CHAIN COUNTERTOP INDUCTION WARMERS

Model	Item No.	Dimensions W x D x H	Voltage Single Phase	Watts	Approx. Ship Weight	List Price
IWRM-CD1-03	IWRMCD13B515	13" x 17¾" x 2¼"	120	360	12 lbs.	\$1959

All Daisy Chain Countertop Induction Warmer Models Feature:
Maximum number of interconnected units: 4 units for US and 4 units for Canada
Models Shipped with: A 71" cord and plug and a 17" interconnecting cord.
Cord Location: Rear right bottom base corner.
Interconnecting Cord Location: Rear left and right bottom base corner.

IWRM-CD1-03 shown with three Daisy Chain Countertop Induction Warmers interconnected to one power cord and chafing dishes (not available)

Quick-Ship Program Information *Inside Back Cover*

DROP-IN INDUCTION WARMERS

Model	Item No.	Dimensions W x D x H	Glass-Ceramic Top.	Voltage Single Phase	Watts	Approx. Ship Weight	List Price
IWRM-B1-1313-06	IWRMB113136B515	13" x 13" x 4¼"	Black	120	600	12 lbs.	\$1763
IWRM-B1-1313-06	IWRMB113136W515	13" x 13" x 4¼"	White	120	600	13 lbs.	1763

All Drop-In Induction Warmer Models Feature:
Models Shipped with: A 39" cable from the base to the control and a 71" cord and plug.
Cord Location: Rear left bottom base corner.

IWRM-B1-1313-06 with white glass-ceramic top

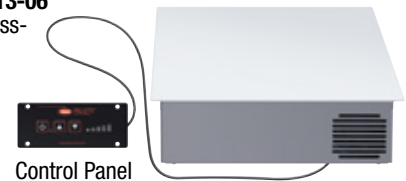

NOTE: Three installation options for a flush or near-flush look: see manual for details.

ACCESSORIES (available for purchase at any time)

TRIM-IWRM-1B	Trim Ring in Stainless Steel (holds unit nearly flush on a stainless steel or any similar material countertop)	\$ 85
IWRM-FLUSHBKT	Flush Mount Bracket (undermount leveling brackets, used with solid material or stainless steel countertop)	109

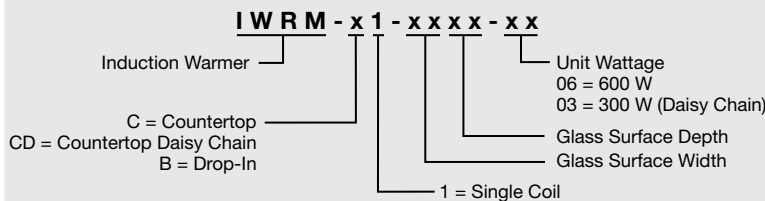



Maskerade® Undercounter Induction Warmers

Hatco's Maskerade® Undercounter Induction Warmers offer a beautiful, flexible and simple solution for "invisible" hot food holding, with five precise low- to high-power warming levels that suit a wide variety of food types to be held safely and at optimum quality.

- Can be mounted under a wide variety of countertop materials, including engineered and natural stone, giving an "invisible" countertop appearance
- Includes a black flexible, highly slip-resistant trivet, which locates the chafing dish and protects the stone from the heat of the pan
- Features a control panel with a standby key, temperature control arrow keys, a lock key and temperature setting indicators
- The power levels are memory retentive, so the last setting will resume when the unit is powered back on
- Pan Sense Technology (PST) activates the unit only when a suitable pan is placed on the trivet
- Energy efficient, quiet and safe operation features an automatic shut-off, which prevents overheating.
- For easy service, the lower housing can be removed separately

IWRM-UT-06



Quick-Ship Program Information *Inside Back Cover*

UNDERCOUNTER INDUCTION WARMERS

Model	Item No.	Dimensions W x D x H	Voltage Single Phase	Watts (per coil)	Approx. Ship Weight	List Price
✓ IWRM-UT-06	IWRMBUT6515	15¼" x 15" x 3⅝"	120	600	17 lbs.	\$2844

All Undercounter Induction Warmer Models Feature:
Models Shipped with: A 71" cord and plug, a 79" control cable, and a trivet.
Cord Location: Rear left bottom base corner.

ACCESSORIES (available for purchase at any time)

IWRM-TRIVET	Black, flexible slip-resistant trivet (locates the chafing dish and protects the stone from heat of pan)	\$179
-------------	--	-------

Scan the QC code for a list of chafing dishes compatible with the Undercounter Induction Warmer



Induction Ranges & Warmers

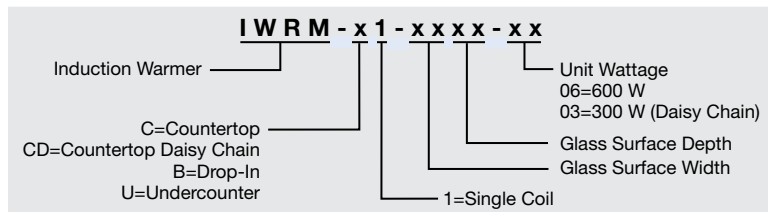

Light Cooking Equipment





Induction Griddle

Built to withstand the rigorous demands of commercial foodservice kitchens, Hatco's heavy-duty Induction Griddle is the ultimate countertop workhorse. This versatile unit delivers exceptional performance across a wide range of menu items — from fluffy pancakes to juicy burgers and more — with a durable, polished steel surface designed for high-volume use. It also includes a wide grease trough, an oversized drain, and a removable grease pan to ensure hassle-free cleanup. This griddle is a must-have for any operation looking to combine efficiency, durability and precision cooking.

- Cooktop reaches 350°F (177°C) in 12 minutes, with a maximum cooking temperature of 550°F (288°C)
- Power Save Mode maintains a lower, user-set temperature to reduce energy use without shutting off the unit
- 12 induction coils deliver consistent, even heat distribution across the entire cooking surface
- Two independently controlled heat zones, each with four temperature sensors, ensure responsive and reliable temperature management
- Each heat zone features a digital readout and control knob for 1° adjustments, offering precise control to reach and maintain desired cooking temperatures



IGRID-2418-FS

INDUCTION GRIDDLE

Model	Dimensions W x D x H	Voltage Single Phase	Watts	Plug	Approx. Ship Weight	List Price
IGRID-2418-FS	24" x 25 ³ / ₄ " x 13 ³ / ₄ "	208-240	6240-7200	NEMA 6-50P	247 lbs.	\$16777

All Drop-In Induction Dry Well Models Feature:

Models Shipped with: A 78" cable from the base to the control and a 71" cord and plug.

Cord Location: Bottom right side.

ACCESSORIES (available for purchase at any time)

Plate Rail – PLATERAIL10	10" Plate Rail	\$478
-----------------------------	----------------	-------

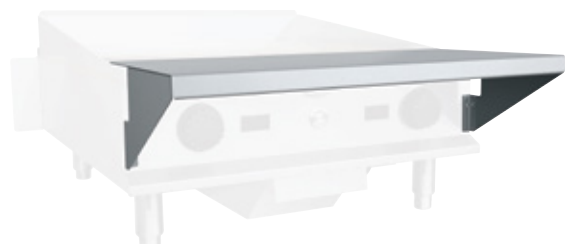

IGRID-2418-FS shown with accessory Plate Rail

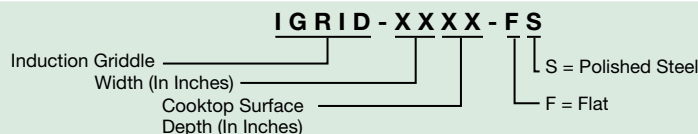



Electric Salamander

Hatco's Electric Salamander gives you versatility in the kitchen with the capability to cook, grill, reheat and keep foods hot. The plate detection feature activates the instant-on heating elements automatically when a food plate comes into contact with the plate detection bar.

- Three independently-controlled Instant-On heating elements provide the benefits of on-demand cooking and energy conservation
- Adjustable upper housing gives 4½" of vertical movement for maximum versatility
- Features high-powered infrared ribbon heating elements
- Heating elements are on only when a cook or hold cycle has been activated, eliminating residual heat in the kitchen environment
- The HOLD function has eight programmable heat levels and is ideal for keeping food hot or for reheating food
- Features a flat, touch control panel and stainless steel construction



ELECTRIC SALAMANDER

Model	Dimensions W x D x H †	Cooking Area W x D	Voltage Single Phase	Watts	Amps	Plug	Approx. Ship Weight	List Price
SAL-1	22¾" x 21¾" x 23 ⁷ / ₈ "	21 ⁷ / ₈ " x 13¾"	208	4500	21.6	NEMA 6-30P	143 lbs.	\$11689
SAL-1	22¾" x 21¾" x 23 ⁷ / ₈ "	21 ⁷ / ₈ " x 13¾"	240	4500	18.8	NEMA 6-30P	143 lbs.	11689

† Height includes 4" legs. Add 2" to depth for wall mounted units.

All Electric Salamander Models Feature:

Models Shipped with: Cooking grate, drip pan, wall mounting hardware, 4" adjustable black plastic legs and cord & plug.

Power Inlet Location: Back of unit, lower right corner.

OPTIONS (available at time of purchase only)

SAL-HW Hardwiring (in lieu of standard 4' Cord and Plug) **No Charge**

FOOD PANS AND TRIVETS – PAGE 240

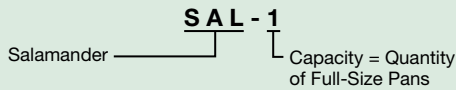

**Saves Energy,
Saves Money,
Protects your Reputation!**

Do your bit for Global Warming with Hatco's SAL-1. The Hatco Electric Salamander's elements are ready for use in just eight seconds. How does that work? Mounted on the back wall of the Salamander is a "plate detection" switch that keeps the unit from turning on unless a plate or pan is put underneath, against this bar. That means the elements are only on when they need to be. Most kitchens have every piece of equipment on all day, firing out heat and constantly using energy. Even in power save mode, most equipment is never fully off. Not the Electric Salamander. It's 100% off when not in use, saving money, energy and the environment.



Panini Grill

The Hatco® Panini Grill will help expand your menu and your sales. Available with a grooved, flat or combination of both surfaces to accommodate all of your grilling needs. Perfect for making anything from sandwiches and quesadillas to chicken and steak. Basically anything that can be grilled can be done right on your countertop without having to have a dedicated grill space. Digital control for both time and temperature help lend to the ease of use. A great addition to any kitchen set up.

- Adjustable time/temperature controls enable operators to cook continuous, consistent quality products
- Exclusive heating elements provide exceptional heat distribution throughout the entire cooking plate, ensuring even cooking of each product
- Compact design is suitable for any location and stainless steel frame provides durability and easy cleaning
- Comes with a scraper and removable crumb tray for easy clean up between uses
- Can use on products up to 3" thick
- Maximum temperature of 500°
- Comes with a scraper and removable grease trough for easy clean up between uses
- Convenient handles on either side of unit make it easy to move from one location to another



PG14G-1
Grooved plates



PG14F-1
Flat plates



PG14FG-1
Grooved top plate,
Flat bottom plate

PANINI GRILL

Model Number	Plate Description		Dimensions (W x D x H)	Voltage	Watts	Amps	Plug	List Price
	Bottom Plate	Top Plate						
PG14G-1	Grooved	Grooved	16 ¹³ / ₁₆ " x 17 ²¹ / ₆₄ " x 8 ¹ / ₂ "	120	1800	15	NEMA 5-20P	\$2798
PG14F-1	Flat	Flat	16 ¹³ / ₁₆ " x 17 ²¹ / ₆₄ " x 8 ¹ / ₂ "	120	1800	15	NEMA 5-20P	2798
PG14FG-1	Flat	Grooved	16 ¹³ / ₁₆ " x 17 ²¹ / ₆₄ " x 8 ¹ / ₂ "	120	1800	15	NEMA 5-20P	2798

ACCESSORIES (available for purchase at any time)

PG SCRAPER **\$11**

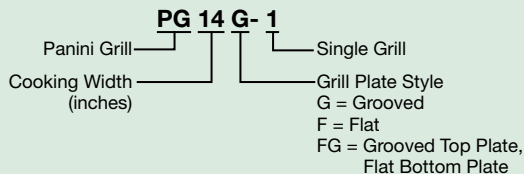



Flip Waffle Maker

Hatco/Suntec Flip Waffle Makers produce excellent, authentic 1¼" thick, round Belgian waffles. Their unique heating elements and 180° swivel mechanism ensure even cooking, while a thermostatic control and a programmable timer deliver consistent, repeatable results. Adjustments to temperature and time can be made to suit any batter and the unit is memory retentive so you may only have to program it once.

- Commercial food service quality – designed for many hours of continuous use, every day
- Heavy duty stainless steel construction with aluminum plates
- Simple push-button control panel features a stand-by on/off, timer/temperature toggle, higher/lower selection, and start
- Easy to see bright red LED display shows settings and countdown when cooking
- Timer starts automatically when waffle maker is closed and resets when opened, while a beeper signals the end of a cooking cycle
- Fast initial heat up time, excellent heat retention and recovery delivers high productivity
- Models shipped with NEMA 5-15P plug and cord (attached)

Standard Round Belgian Plate 7"



Mini Round Waffle Plate available as accessory Four 3½"

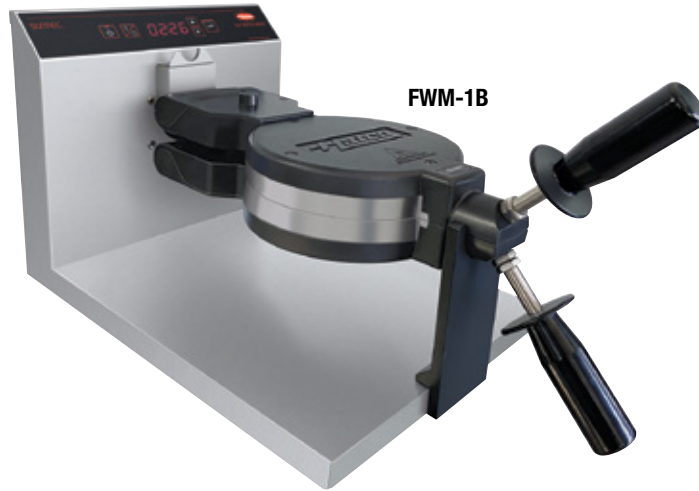
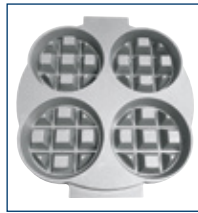

Quick-Ship Program Information *Inside Back Cover*

FLIP WAFFLE MAKER

Model	Item Number	Description	Dimensions (W x D x H)	Voltage	Watts	Amps	Plugs	Approx. Ship Weight	List Price
✓ FWM-1B	FWM1B.515	Round	11½" x 22⅞" x 11½"	120	1350	11.3	NEMA5-15P	27 lbs.	\$3668

All Hatco/Suntec Flip Waffle Maker Models Feature:

Models Shipped with: cord and plug.
Cord Location: Back of unit, lower left side.

ACCESSORIES (available for purchase at any time)

WM-BRUSH	Nylon Brush	\$ 33
WAF-FORK	Waffle Fork	12
MINI-WAFFLE	Mini Waffle Plate	147

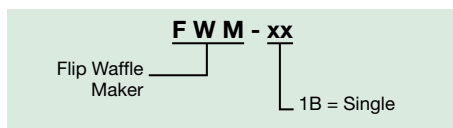



Round Waffle Makers

Hatco®/Suntec Round Waffle Makers cook continuous, excellent-quality waffles for commercial kitchens, display cooking locations, and buffets. The adjustable time and temperature controls enable operators to cook consistent quality waffles from a variety of different batters.

- Exclusive heating elements provide exceptional heat distribution throughout the entire cooking plate, ensuring even cooking of each waffle
- Stainless steel frame, cast aluminum cooking plates
- Belgian-style cooking plates produce 1" thick waffles
- LED display shows timer, temperature and status information
- Simple push button control panel featuring a stand-by On/Off, timer/temp toggle, higher/lower selection, and start/stop
- Fast initial heat-up time, excellent heat retention and recovery delivers high productivity and consistent results



RWM-2



RWM-1B

Quick-Ship Program Information *Inside Back Cover*

ROUND WAFFLE MAKERS

Model	Item Number	Description	Dimensions (W x D x H)	Voltage	Watts	Amps	Plugs	Approx. Ship Weight	List Price
✓ RWM-1	RWM1.515	Single, Round, Standard	9 ⁵ / ₈ " x 17 ³ / ₄ " x 8 ¹ / ₈ "	120	900	7.5	NEMA 5-15P	16 lbs.	\$1680
✓ RWM-1B	RWM1B.515	Single, Round, Belgian	9 ⁵ / ₈ " x 17 ³ / ₄ " x 8 ¹ / ₈ "	120	900	7.5	NEMA 5-15P	16 lbs.	1680
✓ RWM-2	RWM2.520	Double, Round, Standard	19 ⁵ / ₈ " x 17 ³ / ₄ " x 8 ¹ / ₈ "	120	1800	15	NEMA 5-20P	33 lbs.	2926
✓ RWM-2B	RWM2B.520	Double, Round, Belgian	19 ⁵ / ₈ " x 17 ³ / ₄ " x 8 ¹ / ₈ "	120	1800	15	NEMA 5-20P	33 lbs.	2926

All Hatco/Suntec Round Waffle Maker Models Feature:

Models Shipped with: Stainless Steel frame and aluminum cooking plates, On/Off power switch, multi-function control panel, removable drip tray, nylon brush and a 6' cord and plug.

Cord Location: Back of unit, lower left corner

ACCESSORY

(available for purchase at any time)

WM-BRUSH Nylon Brush **\$33**

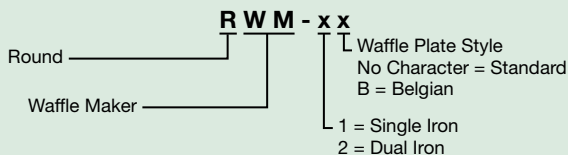



Snack System

The Hatco/Suntec Snack System will help expand your menu and your sales. With a single or dual electric baker, you can easily switch the interchangeable plates to serve breakfast items, lunch foods and a variety of snacks in between. Freshly bake as many or few items as you need, resulting in no waste at the end of the day. Add more variety to your menu in small quantities and increase sales according to the season, time of day and location.

- Four programmable preset buttons for each cooking cycle. A cooking cycle consists of three different settings:
 - Temperature
 - Time
 - Top Cooking Plate Power
- Adjustable time/temperature controls enable operators to cook continuous, consistent quality products
- One-touch release with latch opener for easy plate replacement
- Exclusive heating elements provide exceptional heat distribution throughout the entire cooking plate, ensuring even cooking of each product
- Removable plates are easily cleaned with warm, soapy water
- Compact design is suitable for any location
- Adjustable temperature allows for multiple menu options

NOTE: Comes with standard Round Belgian Waffle Plates and one additional set of plates of your choosing.



SNACK-1 with accessory Chelky plate



SNACK-2 with standard Belgian plate

Quick-Ship Program Information Inside Back Cover

SNACK SYSTEM

Model	Item Number	Description	Dimensions (W x D x H)	Voltage	Watts	Amps	Plugs	Approx. Ship Weight	List Price
✓ SNACK-1	SNACK1.515	Single	10 3/4" x 17 7/8" x 8 1/8"	120	900	7.5	NEMA5-15P	23 lbs.	\$2850
✓ SNACK-2	SNACK2.520	Double	21 1/8" x 17 7/8" x 8 1/8"	120	1800	15	NEMA5-20P	42 lbs.	4617

All Hatco/Suntec Snack System Models Feature:

Models Shipped with: a cleaning brush, tool for switching out plates, standard Round Belgian Waffle Plates and an additional set of plates of your choosing.
Cord Location: Back of unit, bottom left-hand side.

ACCESSORIES

(available for purchase at any time)

Interchangeable Cooking Plates –

FREESTYLE	Freestyle Plates	\$475
BELGIAN	Belgian Plates	475
HEART WAFFLE	Norwegian Waffle Plate	475
COFFEEBEAN	Coffee Bean Plates	475
SANDWICH	Sandwich Plates	475
PANINI	Panini Plates	475
DONUT	Donut Plates	475
CHELKY	Chelky Plates	475
WM-BRUSH	Nylon Brush	\$33

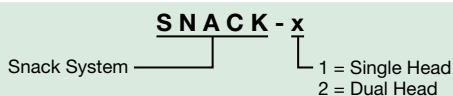
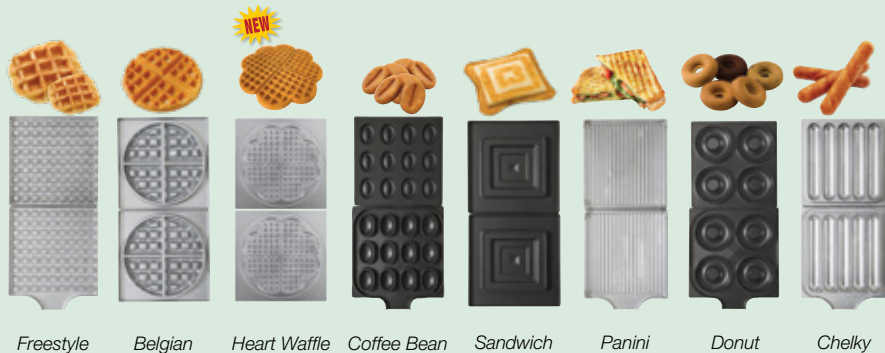

Water Heating & Specialty Equipment





Atmospheric Hot Water Dispenser

At a simple push of a button, the Hatco Atmospheric Hot Water Dispenser delivers pre-measured quantities of hot water for food preparation or cleaning. The compact, durable design uses minimal counter space, while providing up to 8 gallons of continuous hot water. The removable shelf allows access to dispense water into larger containers.

- Quickly delivers 2, 3 or 4 quarts of hot water with the touch of a button
- Program can be interrupted for versatility and convenience
- Manual dispense button for additional water volume options
- 12 gallon stainless steel tank is emptied easily with convenient bottom drain
- Hot water ready in as little as 15 minutes



AWD-12 Pitcher not available

Quick-Ship Program Information Inside Back Cover

ATMOSPHERIC HOT WATER DISPENSER

Model	Dimensions W x D x H ‡	kW	Voltage	Phase	Plug	Approx. Ship Weight	List Price
✓ AWD-12	13 ³ / ₈ " x 27 ¹ / ₂ " x 28 ¹ / ₈ "	5.0	208 or 240	1	NEMA 6-30P.	105 lbs.	\$9408

‡ Height includes 4" legs.

All Hot Water Dispenser Models Feature:

Models Shipped with: Low-water cut-off (LWCO), high temperature limit, electronic temperature controller and digital temperature display.

Distance Between Shelf and Spout: 11³/₄".

Cord Location: Lower left corner on left side.

WATER QUALITY REQUIREMENTS – PAGE 242

WATER TEMPERATURE RECOVERY TABLE

Degrees of Rise										
60°F (33°C)	70°F (39°C)	80°F (44°C)	90°F (50°C)	100°F (55°C)	110°F (61°C)	120°F (66°C)	130°F (72°C)	140°F (78°C)	150°F (83°C)	160°F (88°C)
33 gph (125 lph)	29 gph (110 lph)	25 gph (95 lph)	22 gph (83 lph)	20 gph (75 lph)	18 gph (68 lph)	17 gph (64 lph)	15 gph (57 lph)	14 gph (53 lph)	13 gph (49 lph)	12 gph (45 lph)

gph = gallons per hour
lph = liters per hour

COLD-START HEAT-UP TIME

Degrees of Rise		
60°F (33°C)	90°F (50°C)	140°F (78°C)
22 Minutes	33 Minutes	52 Minutes

WATER TEMPERATURE RECOVERY TIME

Degrees of Rise		
60°F (33°C)	90°F (50°C)	140°F (78°C)
15 Minutes*	22 Minutes*	35 Minutes*

* Recovery times are after 10 gallons (37 liters) of water have been dispensed

OPTIONS (available at time of purchase only)

WALLMOUNT	Wall-Mounting Shelf	\$815
AWD-L6	NEMA L6-30P Locking Cap in lieu of NEMA 6-30P	add 33

ACCESSORIES (available for purchase at any time)

AWD-FILTER	Water Filtration Cartridge for premium quality water (recommended filter change every 15,000 gallons) – Incoming water must be 100°F or less	\$876
AWD-PLUMB	3' Rubber Drain Hose with 10' 1/4" Inlet Tubing	136



AWD-FILTER Accessory
Provides a superior balance of chlorine, taste, and odor reduction. Inhibits limescale build-up

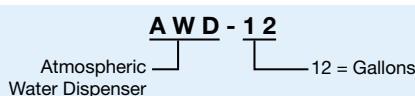



August 1, 2025

Canadian Price List

3CS Sanitizing Sink Heaters

Maintaining a continuous supply of sanitizing rinse water without taking up valuable space, the 3CS makes manual warewashing faster and more convenient. Drain may be plumbed to open-sight waste drain. A special 3CS Sink Heater is available for shipboard use under military spec (MiL-H-43895B) – consult factory for prices.

- Stainless steel front, powdercoated silver-gray hammertone body and convenient side drain
- Equipped with an Energy Cut-Off (ECO) for built-in protection against higher-than-normal water temperature
- An On/Off toggle switch with indicator light to indicate power status, and a red light to indicate the need to refill and reset the unit
- Meets NSF standard of 180°F for dish sanitizing



3CS-9 with optional temperature monitor

SANITIZING SINK HEATERS

Model	kW	Sink Area	Voltage	Phase	Approx. Ship Weight	List Price	
						208 or 240V	480V
3CS-3	3.0	15" Sq. or less	208, 240, 480	1	24 lbs.	\$4904	\$5058
3CS-4	4.5	16"-18" Sq.	208, 240, 480	1	24 lbs.	4540	4694
3CS-6^Δ	6.0	19"-21" Sq.	208, 240, 480	1 or 3	26 lbs.	4629	4783
3CS-9^Δ	9.0	21"-25" Sq.	208, 240, 480	1 or 3	27 lbs.	4904	5058
3CS-3B	3.0	15" Sq. or less	208, 240, 480	Balanced 3	30 lbs.	5132	5286
3CS-4B	4.5	16"-18" Sq.	208, 240, 480	Balanced 3	30 lbs.	5132	5286
3CS-6B	6.0	19"-21" Sq.	208, 240, 480	Balanced 3	30 lbs.	5132	5286
3CS-9B	9.0	21"-25" Sq.	208, 240, 480	Balanced 3	33 lbs.	5132	5286

^Δ Open delta on 3-phase. Larger circuit required than for balanced 3-phase of equal kW.

All Sink Heater Models Feature:

Dimensions 3CS-3, -4, -6, -9: 6¾"W x 16⅞"D x 12⅝"H.

3CS-9 480V, 3CS-3B, -4B, -6B, -9B: 8"W x 17⅞"D x 12⅝"H.

Models Shipped with: Stainless steel front, silver gray hammertone body and black base.

3CS Heaters can be shipped FED-EX GROUND or United Parcel Service.

WATER QUALITY REQUIREMENTS – PAGE 242

OPTIONS (available at time of purchase only)

SSBB	All Stainless Steel Body and Base	\$211
TEMP MON*	Temperature Monitor (Built-In)	216
TEMP LIGHT*	Temperature Light	164
CSA-WIRE	CSA Wiring	109
FR-SECURITY	Security Package (Torx® Screws and Control Cover)	317
MIL-H-43895B	Shipboard use	Consult Factory for Price

ACCESSORIES (available for purchase at any time)

FR-FLUSH	Flush Hose, Stopper and Adapter	\$142
-----------------	---------------------------------	--------------

* Specify either monitor or light, not both.



FR-FLUSH Accessory

SIZING INFORMATION

For a Sink Heater: 2000 WATTS PER SQUARE FOOT of vessel top.

3CS Sink Heaters are sized based on 140°F supply water with a 30 minute preheat period to reach the sanitizing temperature. Sink Heaters are mounted into the third compartment sink with standard plumbing fittings provided. Two 2" diameter holes are required for these fittings and a full size template is provided to locate holes in the sink. The 3CS Sink Heater is easily attached to the plumbing fittings with self-contained unions.

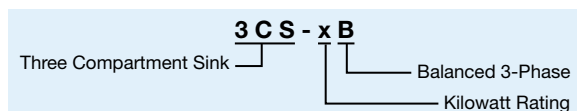
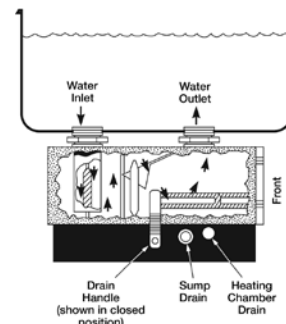



3CS2 Hydro-Heater Sanitizing Sink Heaters

The patented Hatco 3CS2 Hydro-Heater concept features a tubular water chamber with heating elements uniquely wrapped outside the flow tube so elements do not come in contact with the water, eliminating sediment and lime buildup, resulting in longer life. An electronic controller with digital display maintains an accurate setpoint temperature.

- Utilizes “free-flow” technology and advanced electronic controls to assure responsive and efficient operation
- Stainless steel front, powdercoated body, convenient drain outlet and clean-out caps



3CS2-3 with optional auto-fill solenoid

SANITIZING SINK HEATERS

Model	kW	Dimensions W x D x H	Sink Area	Voltage	Phase	Approx. Ship Weight	List Price
3CS2-3	3	7 ³ / ₄ " x 17 ¹ / ₈ " x 12 ³ / ₈ "	15" Sq. or less	208	1	31 lbs.	\$5415
3CS2-4	4	7 ³ / ₄ " x 17 ¹ / ₈ " x 12 ³ / ₈ "	16"-18" Sq.	208, 240	1	31 lbs.	5470
3CS2-6	6	7 ³ / ₄ " x 17 ¹ / ₈ " x 12 ³ / ₈ "	19"-21" Sq.	208	1	31 lbs.	5869
3CS2-3B	3	7 ³ / ₄ " x 17 ¹ / ₈ " x 12 ³ / ₈ "	15" Sq. or less	208, 240	Balanced 3	35 lbs.	6076
3CS2-4B	4	7 ³ / ₄ " x 17 ¹ / ₈ " x 12 ³ / ₈ "	16"-18" Sq.	208, 240	Balanced 3	35 lbs.	6076
3CS2-6B	6	7 ³ / ₄ " x 17 ¹ / ₈ " x 12 ³ / ₈ "	19"-21" Sq.	208, 240	Balanced 3	35 lbs.	6076
3CS2-9B	9	7 ³ / ₄ " x 17 ¹ / ₈ " x 12 ³ / ₈ "	21"-25" Sq.	208	Balanced 3	35 lbs.	6076

All Sink Heater Models Feature:

Models Shipped with: Stainless steel front, powdercoated body, low-water cut-off (LWCO) and electronic temperature monitor. 3CS2 Heaters can be shipped FED-EX GROUND or United Parcel Service.

WATER QUALITY REQUIREMENTS – PAGE 242

OPTIONS (available at time of purchase only)

SSBODY	All Stainless Steel Body and Base	\$211
AUTOFILL	Auto-fill Solenoid	634
REMOTE	Remote Mounted Control	507
HH-SECURITY	Security Package (Torx® Screws and Control Cover)	317

ACCESSORIES (available for purchase at any time)

FR2-FLUSH	Flush Hose, Cleaning Brush, Stopper and Adapter	\$167
-----------	---	-------



FR2-FLUSH Accessory

SIZING INFORMATION

For a Sink Heater: 2000 WATTS PER SQUARE FOOT of vessel top.

3CS2 Sink Heaters are sized based on 140°F supply water with a 30 minute preheat period to reach the sanitizing temperature. Sink Heaters are mounted in the center of the third compartment sink with standard plumbing fittings provided. Two 2" diameter holes are required for these fittings and a full size template is provided to locate holes in the sink. The 3CS2 Sink Heater is easily attached to the plumbing fittings with self-contained unions.

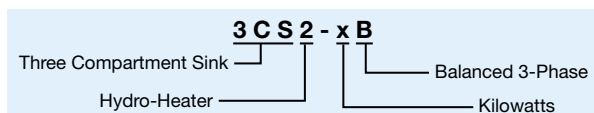



FR Food Rethernalizer/ Bain-Marie Heaters

The Hatco FR is a Bain-Marie or food reconstitutor to heat or hold foods at safe temperatures between 140° and 190°F. All models are shipped factory assembled, pre-wired and include standard 2" stainless steel plumbing fittings for mounting into a holding tank. Drain may be plumbed to open-sight waste drain.

- Equipped with an Energy Cut-Off (ECO) for built-in protection against higher-than-normal water temperature
- Stainless steel tank with five year limited warranty
- Optional low-water cut-off (LWCO) available to prevent element burn out from low-water conditions
- Separate sump and heating compartment drains for cleaning and sanitizing



FR-9

FOOD RETHERMALIZER/BAIN-MARIE HEATERS

Model	kW	Voltage	Phase	Approx. Ship Weight	List Price	
					208 or 240V	480V
FR-3	3.0	208, 240, 480	1	24 lbs.	\$4134	\$4288
FR-4	4.5	208, 240, 480	1	24 lbs.	4182	4336
FR-6 ^Δ	6.0	208, 240, 480	1 or 3	28 lbs.	4616	4770
FR-9 ^Δ	9.0	208, 240, 480	1 or 3	28 lbs.	4726	4880
FR-3B	3.0	208, 240, 480	Balanced 3	30 lbs.	5050	5204
FR-4B	4.5	208, 240, 480	Balanced 3	32 lbs.	5050	5204
FR-6B	6.8	208, 240, 480	Balanced 3	30 lbs.	5050	5204
FR-9B	9.0	208, 240, 480	Balanced 3	30 lbs.	5050	5204

^Δ Open delta on 3-phase. Larger circuit required than for balanced 3-phase of equal kW.

All Food Rethernalizer Models Feature:

Dimensions: FR-3, -4, -6, -9: 6¼"W x 16⅞"D x 12¼"H.

FR Models with 480V and Low Water Cut-Off: 8"W x 17⅞"D x 12¼"H.

FR-3B, -4B, -6B, -9B: 8"W x 17⅞"D x 12¼"H.

Models Shipped with: Stainless steel front, silver gray hammertone body and black base. FR Heaters can be shipped FED-EX GROUND or United Parcel Service.

WATER QUALITY REQUIREMENTS – PAGE 242

OPTIONS (available at time of purchase only)

SSBB	All Stainless Steel Body and Base	\$211
W/LW	Low-Water Cut-Off	353
CSA-WIRE	CSA Wiring (Canadian models only – not available with Cord and Plug)	109
FR-SECURITY	Security Package (Torx® Screws and Control Cover)	317

ACCESSORIES (available for purchase at any time)

FR-FLUSH	Flush Hose, Stopper and Adapter	\$142
----------	---------------------------------	-------



FR-FLUSH Accessory

SIZING INFORMATION

For a Bain-Marie or steam table: MINIMUM 750 WATTS PER SQUARE FOOT of vessel top.

For a Food Rethernalizer: MINIMUM 2000 WATTS PER SQUARE FOOT of vessel top.

Use one FR for a Bain-Marie up to 6' long. Units over 6' require a minimum of two FRs. (Tank Baffle supplied by installer.)

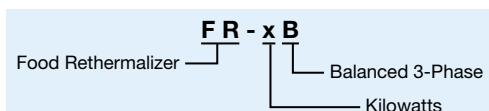
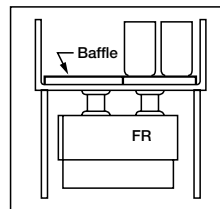



FR2 Hydro-Heater Food Rethermalizer/ Bain-Marie Heaters

The patented Hatco FR2 Hydro-Heater concept features a tubular water chamber with heating elements uniquely wrapped outside the flow tube so elements do not come in contact with the water, eliminating sediment and lime buildup, resulting in longer life. An electronic controller with digital display maintains an accurate setpoint temperature.

- Utilizes “free-flow” technology and advanced electronic controls to assure responsive and efficient operation
- Stainless steel front, powdercoated body, convenient drain outlet and clean-out caps



FR2-3 with optional Stainless Steel body and base

FOOD RETHERMALIZER/BAIN-MARIE HEATERS

Model	Dimensions W x D x H	kW	Voltage 50/60Hz	Phase	Approx. Ship Weight	List Price
FR2-3	7¾" x 17½" x 12¾"	3	208	1	34 lbs.	\$5408
FR2-4	7¾" x 17½" x 12¾"	4	208, 240	1	34 lbs.	5470
FR2-6	7¾" x 17½" x 12¾"	6	208	1	34 lbs.	5842
FR2-3B	7¾" x 17½" x 12¾"	3	208, 240	Balanced 3	34 lbs.	6069
FR2-4B	7¾" x 17½" x 12¾"	4	208, 240	Balanced 3	34 lbs.	6069
FR2-6B	7¾" x 17½" x 12¾"	6	208, 240	Balanced 3	34 lbs.	6069
FR2-9B	7¾" x 17½" x 12¾"	9	208	Balanced 3	34 lbs.	6069

All Food Rethermalizer Models Feature:

Models Shipped with: Stainless steel front, powdercoated body, low-water cut-off (LWCO) and electronic temperature monitor. FR2 Heaters can be shipped FED-EX GROUND or United Parcel Service.

WATER QUALITY REQUIREMENTS – PAGE 242

OPTIONS (available at time of purchase only)

SSBODY	All Stainless Steel Body and Base	\$211
AUTOFILL	Auto-fill Solenoid	634
REMOTE	Remote Mounted Control	507
HH-SECURITY	Security Package (Torx® Screws and Control Cover)	317

ACCESSORIES (available for purchase at any time)

FR2-FLUSH	Flush Hose, Cleaning Brush, Stopper and Adapter	\$167
-----------	---	-------



FR2-FLUSH Accessory

SIZING INFORMATION

For a Bain-Marie or steam table: MINIMUM 750 WATTS PER SQUARE FOOT of vessel top.

For a Food Rethermalizer: MINIMUM 2000 WATTS PER SQUARE FOOT of vessel top. Use one FR2 for a Bain-Marie up to 6' long. Over 6', minimum two required.

MUST BE INSTALLED WITH A PERFORATED WATER BAFFLE. This baffle is not supplied with heater. The FR2 should be positioned with no more than 3' on either side when mounted in holding vessel. Consult factory or installation manual for fabricating details.

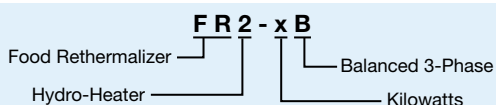



Powermite® Gas Booster Water Heaters

The Powermite® Gas Booster Water Heater provides 180°F sanitizing hot water and long life dependability. Models can be supplied to operate on either natural or propane gas and feature a burner system that utilizes both primary and secondary air for consistent ignition. Available for U.S. and Canada only.

- Features stainless steel tanks – front and top, powdercoated sides and back, finned tube copper heat exchanger, temperature relief valve, pressure reducing valve, two temperature/pressure gauges, blended phosphate water treatment system, shock absorber and low-water cut-off (LWCO)
- Spark to light with standing pilot
- PMG-100 has 3 tube type burners, and PMG-200 has 6 tube type burners



PMG-100

Quick-Ship Program Information *Inside Back Cover*

GAS BOOSTER WATER HEATERS

Model*	Input BTUs/Hour	Output	Dimensions W x D x H ‡	Approx. Ship Weight	List Price
✓ PMG-100	105,000	84,800 = 24.8kW	27½" x 20¾" x 31"	193 lbs.	\$27129
✓ PMG-200	195,000	156,000 = 45.7kW	36" x 20¾" x 31"	228 lbs.	32178

* Quick Ship Models are manufactured with orifice kits up to 2000 ft elevation. Higher elevations are production units - please note the elevation on order.

‡ Height includes legs. Width & Depth does not include temperature pressure relief valve dimensions.

All Gas Booster Water Heater Models Feature:

Electrical Supply: 120 VAC, 360 watt, 3.00 amp.

Connections: Gas – ¾" NPT, Water – ¾" NPT, Electric – 120 VAC, 15 amp.

Fuel: Standard – Natural gas. Optional – Propane gas.

Models Shipped with: Stainless steel tank/front/top, powdercoated sides and back, blended phosphate water treatment system, low-water cut-off (LWCO), temperature/pressure relief valve, pressure reducing valve, shock absorber, two temperature/pressure gauges, indicator light and On/Off switch.

Water Capacity: 4¾ gallons.

Natural Gas Inlet Pressure Inches Water Column: Min. – 5.0. Max. – 10.5.

Propane/LP Gas Inlet Pressure Inches Water Column: Min. – 11.0. Max. – 13.0.

Operating Pressure Specifications at Manifold –

Inches Water Column at Pressure Tap: Natural Gas – 3.5. Propane/LP Gas – 10.0.

Direct Fluing: Combustion air enters bottom, flue gasses exit right side or back at top of unit.

Vent^: Forced draft system with 4" diameter vent pipe adapter.

^ Before installing any method of venting contact the local code authority or gas supplier to make sure the final installation will be acceptable to the authorities who have jurisdiction. See Installation Manual at www.hatcocorp.com for more venting information.

NOTE: Pages 236-238 for sizing information.

WATER QUALITY REQUIREMENTS – PAGE 242

OPTIONS (available at time of purchase only)

Stainless Steel Body and Base –

SSBB	PMG-100	\$444
SSBB	PMG-200	539
PMG-SECURITY	Security Package (Torx® Screws and Control Cover)	\$322

ACCESSORIES (available for purchase at any time)

QSFLORMOUNT	Additional Stainless Steel Floor Mounting Leg Assembly	\$603
QSBPRV	Back Pressure Relief Valve (page 234 for illustration)	347
QSPRVB	Additional Brass Pressure Reducing Valve with Bypass	340
QSSSA-LEGS	Additional Stainless Steel Adjustable Legs (6"-7")	387
PMG-AI	Air Interlock Switch	344
ORIF	High Altitude Kit for gas and elevation – applicable at 2000 feet and above (PMG-200 only)	No Charge

NOTE: 6" plastic adjustable legs (6"-7") standard. Description of accessories is shown on page 234.



PMG-AI Accessory



ORIF Accessory

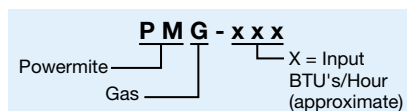



Mini-Compact Electric Booster Water Heaters

The Mini-Compact specialty heater features a stainless steel tank and fast recovery, making it ideal for hot water sanitizing. This heater includes stainless steel front with powdercoated silver gray hammertone body, black base, 6" legs and a storage capacity of 3.2 gallons.

- Provides 180°F water for hot water sanitizing
- Features temperature/pressure relief valve, a pressure reducing valve, two temperature/pressure gauges, a high-temperature limit control and a low-water cut-off (LWCO)



MC-10

SPECIALTY ELECTRIC BOOSTER WATER HEATERS

Model	Dimensions (W x D x H †)	kW	Voltage	Phase	Approx. Ship Weight	List Price	
						208 or 240V	480V
MC-10 ‹	11¾" x 12⅞" x 18½"	9.9	208	1, 3	48 lbs.	\$5876	\$5953
MC-11 ‹	11¾" x 12⅞" x 18½"	11.4	240, 480	1, 3	48 lbs.	5876	5953
MC-15	11¾" x 12⅞" x 18½"	15	208	3	49 lbs.	6358	6435
MC-17	11¾" x 12⅞" x 18½"	17.25	208	3	48 lbs.	6427	6504

‹ Must specify phase. Not field-convertible.

† Height includes 6"(152 mm) legs.

All Specialty Electric Booster Water Heater Models Feature:

Models Shipped with: Low-water cut-off (LWCO), temperature/pressure relief valve, pressure reducing valve and two temperature/pressure gauges.

WATER QUALITY REQUIREMENTS – PAGE 242

Quick-Ship Program Information *Inside Back Cover*

OPTIONS (available at time of purchase only)

MCL-SSJA	Stainless Steel Body and Base	\$ 242
-----------------	-------------------------------	---------------

ACCESSORIES (available for purchase at any time)

	QSWATERTREAT	Blended Phosphate Injection System – not for potable water use (page 234 for illustration)	\$1558
	QSSHOCK	Shock Absorber to reduce water hammer	222
	QSPRVB	Additional Brass Pressure Reducing Valve	340
	QSSSA-LEGS	Additional Stainless Steel Adjustable Legs (6"-7")	387

NOTE: 6" plastic adjustable legs (6"-7") standard. Description of accessories is shown on page 234.

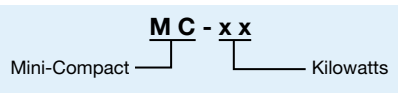



August 1, 2025

Canadian Price List

Compact Electric Booster Water Heaters

Compact models provide all the 180°F final rinse water to sanitize and flash-dry dishes and flatware. Models include stainless steel front panel, silver gray hammertone body, black base and standard 6" plastic legs. Slide brackets for mounting under a dishtable are available. The Castone® lined tank is standard on all models and has a six gallon capacity.

- The Compact Electric Booster is easy to install next to a dishwasher to save space, either on 6" plastic legs or with accessory slide brackets
- All models include a Castone® lined tank with a 10-year limited warranty, and fiberglass insulation to minimize heat loss
- Swing-away front panels with low-water cut-off (LWCO), control fuses and transformer allow quick access to probes and elements, for easier serviceability



C-18 with optional Stainless Steel body and base



C-45

NOTE: Single phase is uncommon in heaters 24kW and larger and are NOT returnable.

Quick-Ship Program Information Inside Back Cover

COMPACT ELECTRIC BOOSTER WATER HEATERS

Model [◀]	kW	Voltage			Approx. Ship Weight	List Prices		
		208V Single Ph	240V Single Ph	208V Three Ph		240V Three Ph	480V or 600V Three Ph	208 or 240V
Small								
C-4 [↗]	4	✓		—	—	115 lbs.	\$6213	\$6213
C-5 [↗]	5	✓		—	—	115 lbs.	6296	6296
C-6	6	✓	✓	✓	✓	118 lbs.	6406	6406
C-7	7	✓	✓	✓	✓	118 lbs.	6496	6496
C-9	9	✓	✓	✓	✓	118 lbs.	6565	6565
C-12*	12	✓	✓	✓	✓	120 lbs.	6944	6944
C-13	13.5					120 lbs.	6992	6992
C-15*	15	✓	✓	✓	✓	120 lbs.	7081	7081
C-17	17.25	—	—	✓	—	120 lbs.	7129	7129
C-18	18			—		120 lbs.	7185	7185
Large								
C-24	24			✓		142 lbs.	\$ 9561	\$ 9561
C-27*	27			✓	✓	142 lbs.	9705	9705
C-30*	30			✓	✓	142 lbs.	9795	9795
C-36*	36			✓	✓	142 lbs.	10242	10132
C-39	39			✓	✓	142 lbs.	10428	10311
C-45*	45	—		✓	✓	142 lbs.	11606	11482
C-54*	54	—	—	✓	✓	142 lbs.	11923	11792
C-57*	57	—	—	✓	✓	142 lbs.	12164	12026

◀ Only 6, 7 & 9kW models can be field converted to single phase (units are shipped 3-phase open delta). Larger branch circuit required than for balanced 3-phase of equal kW. (Balanced 3-phase available in 4-6 & 9kW models, consult factory.)
208 and 240 volt only.

* 600V not available in Quick-Ship

↗ 480V available in single phase only.

Contact factory if Balanced 3 Ph is required.

All Compact Electric Booster Water Heater Models Feature:

Voltage: 208, 240, 480 and 600.

Dimensions: Models C-4 through C-18: 13"W x 20 3/4"D x 19 3/4"H. Add 5/4" to depth for temperature/pressure relief valve. Height includes legs.

Models C-24 through C-57: 18"W x 24"D x 18"H. Add 6 1/2" to depth for temperature/pressure relief valve. Height includes legs.

Models Shipped with: Castone® tank, low-water cut-off (LWCO), temperature/pressure relief valve, pressure reducing valve, two temperature/pressure gauges, 6" black plastic non-adjustable legs, indicator light and On/Off switch.

Compact Booster Water Heaters are not recommended for shipment via FED-EX GROUND or United Parcel Service.

NOTE: Pages 236-238 for sizing information.

NOTE: Consult page 239 for proper breaker size. Verify amperage load for Booster Heaters 24kW through 57kW in single phase. Because of excessively high amps and since these units are NOT field convertible to any other voltage or phase, written confirmation is required before processing can begin.

OPTIONS AND ACCESSORIES – PAGE 231

LOW-TEMP DISHWASHERS – SEE LOW-TEMP SIZING DATA ON PAGE 235

WATER QUALITY REQUIREMENTS – PAGE 242

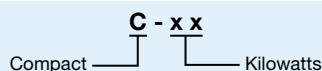



C-27 with accessory slide brackets

Quick-Ship Program Information *Inside Back Cover*

OPTIONS (available at time of purchase only)

SSBB	Stainless Steel Body and Base	No Charge
C-SECURITY	Security Package (Torx® Screws and Control Cover)	\$328

ACCESSORIES (available for purchase at any time)

	QSFLOORMOUNT	Additional Stainless Steel Floor Mounting Leg Assembly	\$ 603
	QSWATERTREAT	Blended Phosphate Injection System – not for potable water use (page 234 for illustration)	1558
	QSSHOCK	Shock Absorber to reduce water hammer	222
	QSBPRV	Back Pressure Relief Valve	347
	QSPRVB	Additional Brass Pressure Reducing Valve with Bypass	340
	QSSSA-LEGS	Additional Stainless Steel Adjustable Legs (6"-7")	387
	QSB00STERBRKT	Additional Slide Brackets	136

NOTE: 6" plastic adjustable legs (6"-7") standard. Description of accessories is shown on page 234.

WATER TEMPERATURE RECOVERY TABLE

Compact Model	40°F Rise	70°F Rise	Compact Model	40°F Rise	70°F Rise
C-4	40 gph	23 gph	C-18	181 gph	103 gph
C-5	50 gph	29 gph	C-24	241 gph	138 gph
C-6	60 gph	34 gph	C-27	271 gph	155 gph
C-7	70 gph	40 gph	C-30	301 gph	172 gph
C-9	90 gph	52 gph	C-36	361 gph	206 gph
C-12	120 gph	69 gph	C-39	391 gph	224 gph
C-13	135 gph	77 gph	C-45	452 gph	258 gph
C-15	151 gph	86 gph	C-54	542 gph	310 gph
C-17	173 gph	99 gph	C-57	573 gph	326 gph

NOTE: gph is "gallons per hour."



August 1, 2025

Canadian Price List

Imperial Electric Booster Water Heaters

Imperial Booster Water Heaters combine quality construction and rugged dependability to provide up to 573 gph of 180°F sanitizing rinse water. Models include stainless steel front panel, silver gray hammertone body, black base, standard 6" legs, Castone® lined tank and have a 16-gallon capacity.

- All models include a Castone® lined tank with a 10-year limited warranty
- Features temperature/pressure relief valve, two temperature gauges, a high-temperature limit control, pilot indicator light, On/Off switch and a low-water cut-off (LWCO) to prevent element burnout due to low water conditions
- Built-in heat trap and fiberglass insulation minimizes heat loss
- Stainless steel front panel and powdercoated silver-gray hammertone body is standard on all Imperial models



S-54

NOTE: Single phase is uncommon in heaters 24kW and larger and are NOT returnable.

Quick-Ship Program Information Inside Back Cover

IMPERIAL ELECTRIC BOOSTER WATER HEATERS

Model [Ⓢ]	kW	Voltage			Approx. Ship Weight	List Prices	
		208V Single Ph	240V Single Ph	208V Three Ph		240V Three Ph	480V or 600V Three Ph
Small							
S-6	6				200 lbs.	\$9003	\$9003
S-7	7				200 lbs.	9127	9127
S-9	9				200 lbs.	9189	9189
S-12	12			✓	200 lbs.	9705	9705
S-13	13.5				200 lbs.	9726	9726
S-15	15			✓	200 lbs.	9795	9795
S-17	17.25	—	—		200 lbs.	9850	9850
S-18	18			—	200 lbs.	9919	9919
Large							
S-24	24				214 lbs.	\$11337	\$11337
S-27	27				214 lbs.	11420	11420
S-30	30				214 lbs.	11585	11585
S-36*	36			✓	214 lbs.	12405	12357
S-39	39				214 lbs.	12556	12501
S-40	40.5	—	—		224 lbs.	12977	12915
S-45*	45	—	—	✓	224 lbs.	13176	13107
S-54*	54	—	—	✓	224 lbs.	13211	13135
S-57	57	—	—		224 lbs.	13445	13362

Ⓢ Only 6, 7 & 9kW models can be field converted to single phase (units are shipped 3-phase open delta). Larger branch circuit required than for balanced 3-phase of equal kW. (Balanced 3-phase available in 6 & 9kW models, consult factory.) 208 and 240V only.

* 600V not available in Quick-Ship.

All Imperial Electric Booster Water Heater Models Feature:

Voltage: 208, 240, 480 and 600.

Dimensions: 23⁵/₈"W x 22³/₄"D x 31¹/₈"H. Add 5" to width for temperature/pressure relief valve. Height includes legs.

Models Shipped with: Castone® tank, low-water cut-off (LWCO), temperature/pressure relief valve, pressure reducing valve, two temperature/pressure gauges, 6" black plastic, non-adjustable legs, indicator light and On/Off switch.

NOTE: Pages 236-238 for sizing information.

NOTE: Consult page 239 for proper breaker size. Verify amperage load for Booster Heaters 24kW through 57kW in single phase. Because of excessively high amps and since these units are NOT field convertible to any other voltage or phase, written confirmation is required before processing can begin.

OPTIONS AND ACCESSORIES – PAGE 233

LOW-TEMP DISHWASHERS – SEE LOW-TEMP SIZING DATA ON PAGE 235

WATER QUALITY REQUIREMENTS – PAGE 242

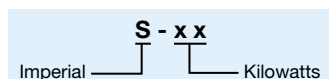



S-57 with optional Stainless Steel body and base, and accessory Stainless Steel legs

Quick-Ship Program Information *Inside Back Cover*

OPTIONS (available at time of purchase only)

SSBB	Stainless Steel Body and Base	No Charge
S-SECURITY	Security Package (Torx® Screws and Control Cover)	\$328

ACCESSORIES (available for purchase at any time)

	QSFLOORMOUNT	Additional Stainless Steel Floor Mounting Leg Assembly	\$ 603
	QSWATERTREAT	Blended Phosphate Injection System – not for potable water use (page 234 for illustration)	1558
	QSSHOCK	Shock Absorber to reduce water hammer	222
	QSBPRV	Back Pressure Relief Valve	347
	QSPRVB	Additional Brass Pressure Reducing Valve with Bypass	340
	QSSSA-LEGS	Additional Stainless Steel Adjustable Legs (6"-7")	387

NOTE: 6" plastic adjustable legs (6"-7") standard.
Description of accessories is shown on page 234. Only leg mounting is available.

WATER TEMPERATURE RECOVERY TABLE

Imperial Model	40°F Rise	70°F Rise	Imperial Model	40°F Rise	70°F Rise
S-6	60 gph	34 gph	S-24	241 gph	138 gph
S-7	70 gph	40 gph	S-27	271 gph	155 gph
S-9	90 gph	52 gph	S-30	301 gph	172 gph
S-12	120 gph	69 gph	S-36	361 gph	206 gph
S-13	135 gph	77 gph	S-39	391 gph	224 gph
S-15	151 gph	86 gph	S-40	407 gph	232 gph
S-17	173 gph	99 gph	S-45	452 gph	258 gph
S-18	181 gph	103 gph	S-54	542 gph	310 gph
			S-57	573 gph	326 gph

NOTE: gph is "gallons per hour."



Booster Installation

SINGLE BOOSTER INSTALLATION

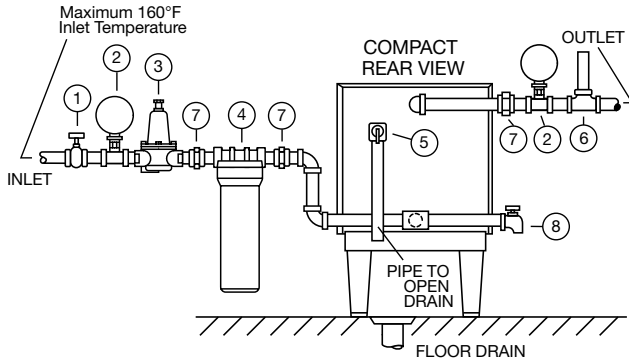

DUAL BOOSTER INSTALLATION

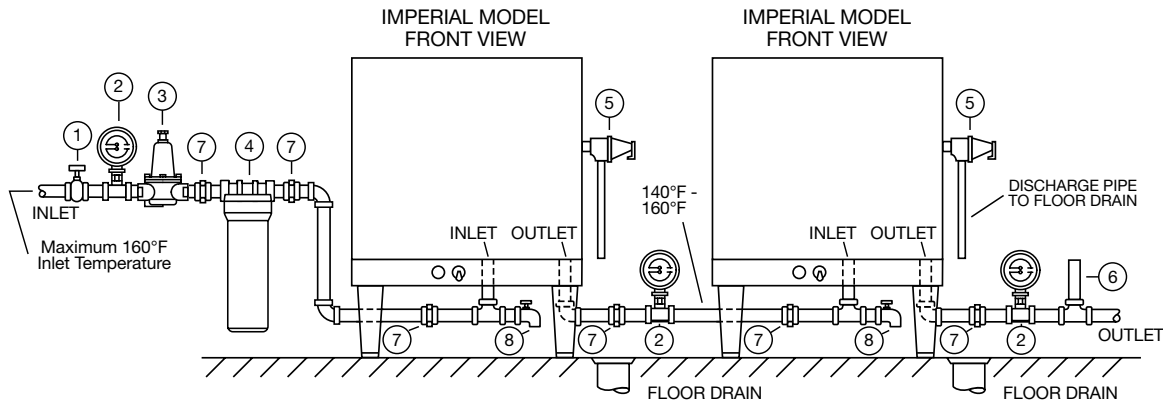

- ① 3/4" Gate or Ball Valve* ② Temperature/Pressure Gauge ③ Pressure Reducing Valve with By-Pass ④ Blended Phosphate Water Treatment System
 ⑤ Relief Valve (must have discharge pipe to floor drain) ⑥ Shock Absorber ⑦ Union* ⑧ Drain Pipe Valve* *Supplied by installer

CONSULT LOCAL CODES

NOTE: The differential temperature between outlet and inlet temperatures should never be less than 20°F.

NOTE: Thermostat calibration, or adjustment, must be performed at time of installation and is excluded from warranty coverage. Thermostat adjustments for Low-Temp applications are the responsibility of the installer.

BOOSTER WATER HEATER ACCESSORIES

Back Pressure Relief Valve –

This valve relieves pressure when unit is heating, on models that a check valve is required on the supply line. To be plumbed over an open site drain.



Bronze Pressure Reducing Valve –

This valve provides reduced corrosion and lead-free compliance. This adjusts water flow pressure to 20 psi.



Stainless Steel Adjustable Legs – Adjustable from 6" to 7". Clean appearance and heavy-duty for long wear.



Floor Mounting Hardware – Adjustable from 6" to 7". Corrosion-resistant stainless steel legs for deck mounting.



Blended Phosphate Water Treatment System –

Standard and required with Powermite® units. Minimizes scale formation and increases unit efficiency. Recommended for Electric Boosters. (Not for potable water use.)

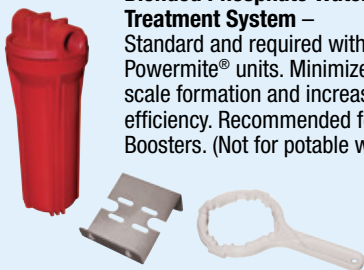

Shock Absorber – Recommended between the booster and the dishwasher to prevent water hammer. Standard with Powermite® gas boosters.

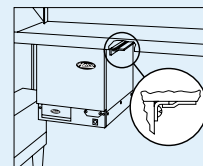

Slide Bracket – For mounting the booster heater under a dishwasher (available on small and large Compact models only).





Water Heater Data

PLUMBING DATA

Dielectric couplings should be used in connecting dissimilar metals, such as galvanized to copper, to prevent electrolysis.

All Hatco Booster Water Heaters require 3/4" piping.

A check valve should not be installed in the supply line to the booster heater.

All shut-off valves must be gate or ball valves – not globe valves.

BOOSTER HEATER SIZING FORMULA

$$\left(\frac{\text{GPH} \times \text{°F Temp. Rise}}{400} = \text{kW} \right)$$

NOTE: GPH is gallons per hour.

SEE BOOSTER HEATER SIZING CHART, PAGES 236-238.

ELECTRICAL FORMULAS

$$\text{Watts} = \text{Amps} \times \text{Volts} \quad \text{1-phase}$$

$$\frac{\text{Watts} \times .86}{\text{Volts}} = \text{Amps} \quad \text{3-phase (open delta)}$$

$$\frac{\text{Watts}}{\text{Volts} \times 1.73} = \text{Amps} \quad \text{3-phase (balanced delta)}$$

NOTE: When primary temperatures are less than 85°F consult factory for suitable booster heater.

WATER TEMPERATURE RECOVERY TABLE IN GPH °F RISE

kW	30°	40°	50°	60°	70°	80°	90°	100°
4	54	40	32	27	23	20	18	16
5	67	50	40	33	29	25	22	20
6	80	60	48	40	34	30	27	24
7	94	70	56	47	40	35	31	28
9	120	90	72	60	52	45	40	36
9.9	132	99	79	66	57	50	44	40
10.5	140	105	84	70	60	53	47	42
11.4	153	114	92	76	65	57	51	46
12	161	120	96	80	69	60	54	48
13.5	181	135	108	90	77	68	60	54
15	201	151	120	100	86	75	67	60
17.25	231	173	139	115	99	87	77	69
18	241	181	145	120	103	90	80	72
24	321	241	193	161	138	120	107	96
27	361	271	217	181	155	135	120	108
30	401	301	241	201	172	151	134	120
36	482	361	289	241	206	181	161	145
39	522	391	313	261	224	196	174	157
40.5	542	407	325	271	232	203	181	163
45	602	452	361	301	258	226	201	181
54	723	542	434	361	310	271	241	217
57	763	573	458	381	326	286	254	229

Sizing Chart For Low-Temp Dishmachines

BOOSTERS RATED AT 30°F RISE

Dishwasher Model Number	Electric Compact Booster	Electric Imperial Booster	Dishwasher Model Number	Electric Compact Booster	Electric Imperial Booster
AMERICAN DISH SERVICE			CHAMPION		
AH, AH-3D, AH-3D-S, AHC, AHC-3D, AHC-3D-S, ET-A, T-AF, ET-AH, ET-A-M, ET-AH-M, ET-A-3, ET-AH-3, L-90-3D, L-90-3D-K, L-90-3D-K-S, L-90-3D-S, L-90-3DC, L-90-3DC-K, L-90-3DC-K-S, L-90-3DC-S, L-90-3DW, L-90-3DW-K, L-90-3DW-K-S, L-90-3DW-S, L-90-3DWC, L-90-3DWC-K, L-90-3DWC-K-S, L-90-3DWC-S, WH, WHC	C-4	S-6	ULD, ULF	C-6	S-6
A-3D, A-3D-S, A, AC, AC-3D, AC-3D-S, AH-B, ET-AF-3, ET-AF-M, HT-25, L-60-3D, L-60-3D-K, L-60-3D-K-S, L-60-3D-S, L-60-3DC, L-60-3DC-K, L-60-3DC-K-S, L-60-3DC-S, L-60-3DW, L-60-3DW-K, L-60-3DW-K-S, L-60-3DW-S, L-60-3DWC, L-60-3DWC-K, L-60-3DWC-K-S, L-60-3DWC-S, L-72-3D, L-72-3D-K, L-72-3D-K-S, L-72-3D-S, L-72-3DC, L-72-3DC-K, L-72-3DC-K-S, L-72-3DC-S, L-72-3DW, L-72-3DW-K, L-72-3DW-K-S, L-72-3DW-S, L-72-3DWC, L-72-3DWC-K, L-72-3DWC-K-S, L-72-3DWC-S, W, WC	C-5	S-6	DLF	C-13	S-13
A-B, AD-25, SS-25, 5-AH, 5-AHS	C-6	S-6	KL44, KL66	C-36	S-36
AF, AF-3D, AF-3D-S, AF-B, AFC, AFC-3D, AFC-3D-S, AFW, AFWC, 5, 5-S	C-7	S-7	GMA DISHMACHINES		
ADC-44, ADC-66, 5-AG, 5-AGS, 5-CD-LF, 5-CD-RF	C-9	S-9	A-1, AH-1, C-1, VAC-1, A-3, AH-3, C-3, L-1C, VAC-3, VAC-4, VAC-5, L-1X	C-4	S-6
BLAKESLEE			A-2, AH-1, AH-2, AH-3, B-3, C-1, C-2, C-3, EVA-1, EVA-2, EVA-3, EVA-4, EVA-5, VAC-2	C-6	S-6
U21-C	C-4	S-6	B-1	C-7	S-7
D-8-LT	C-6	S-6	B-2	C-9	S-9
DD-8-LT, R-CC64-LT, R-EE-LT	C-12	S-12	CMA-44L with tank heater, CMA-66L	C-24	S-24
Series XF-EE-LT, XF-PEE-LT, XF-LL-LT, XF-PLL-LT, XF-MM-LT, XF-PMM-LT, XF-EEE-LT, XF-LLL-LT, XF-MMM-LT	C-13	S-13	CVA-1, CVA-2, CVA-3, CVA-4	C-6	S-6
Series R-L-LT, R-PL-LT, R-M-LT, R-PM-LT, F-L-LT, F-PL-LT, F-M-LT, F-PM-LT (single tank)	C-36	S-36	CVA-5	C-7	S-7
Series "R" & "F"-CC-LT, -EE-LT, -LL-LT, -MM-LT, -LLL-LT, -MMM-LT, -PCC-LT, -PEE-LT, -PLL-LT, -PMM-LT (multi-tank)	C-24	S-24	HOBART		
Series XF-L-LT, XF-PL-LT, XF-M-LT, XF-PM-LT (single tank)	C-54	S-54	LX-18C, LX-30C, LX-40C, WM-5C, SR24C	C-4	S-6
Series XF-PEE-LT, XF-PLL-LT, XF-PMM-LT, XF-EEE-LT, XF-LLL-LT, XF-MMM-LT (multi-tank)	C-36	S-36	LT-1	C-6	S-6
FA (Flight-A-Round) and RA (Rack-A-Round) use comparable "F" listing.			AM-14, AM-14C	C-7	S-7
			C44A, CRS66A, CPW80A	C-27	S-27
			FT-800	C-30	S-30
			JACKSON		
			Conservor 24LT, 200LT, ES1000 (Ecolab/Jackson)	C-4	S-6
			Conservor 1, Conservor XL, ES2000 (Ecolab/Jackson)	C-9	S-9
			Conservor 2, Conservor XL2, ES4000 (Ecolab/Jackson)	C-15	S-15
			AJ-44, AJ-66, AJ-80	C-18	S-18
			KNIGHT EQUIPMENT LTD.		
			KLE-112-HL	C-5	S-6
			KLE-117i, KLE-117c, KLE-175GT, KLE-175GTM	C-9	S-9
			KLE-235d	C-13	S-13
			KLE-175GT Corner, KLE-175GTM Corner	C-12	S-12

Low-Temp Sizing Data

Chemical low-temp dishwashers are most effective when supplied with a 140°F hot water supply. Sometimes this water temperature is not available due to undersized primary water heaters or local safety codes. Hatco can provide a pre-heater for chemical low-temp dishwashers to provide an adequate supply of 140°F hot water for proper operation.

NOTE: When ordering a heater for use with a chemical low-temp dishwasher, thermostat adjustments for low-temp applications are the responsibility of the installer.

To properly size a Hatco heater for low-temp use:

- Determine the required temperature rise by subtracting the available hot water supply temperature from 140°F. This should be a minimum of 30°F.
- Determine the water usage by consulting the dishwasher data plate, literature, or NSF listing. This should be shown as gallons per hour (GPH).
- Use the Hatco formula for sizing or the sizing chart on this page to determine the required kW and select the appropriate Hatco model.



Booster Heater Sizing Chart

Dishwasher Model Number	Electric Compact Booster Temperature Rise		Electric Imperial Booster Temperature Rise		Gas Powermite® Booster [□] Temperature Rise [□]	
	40°F	70°F	40°F	70°F	40°F	70°F
ADAMATION						
CSL-1390, CA-2, CA-3, CA-4, SLAP 44	C-39	(2)C-36	S-39	(2)S-36	PMG-200	(2)PMG-200
CA, CA-1	C-54	(2)C-45	S-54	(2)S-45	PMG-200	(2)PMG-200
ALVEY						
FLC-10, SL-2S			S-6	S-9		
FLC-12, CL-1, CL-1Turntable, SA-5A			S-7	S-12		
FL-2S			S-9	S-13		
KS-70, KS70M SB			S-9	S-15		
SL-2D			S-13	S-18		
FLC-36			S-15	S-27		
KS-88-C			S-18	S-30		
KS-70-N, KS-88-N			S-39	(2)S-40		
AMERICAN DISH SERVICE						
AF-ES, AFC-ES	C-4	C-7	S-4	S-7		
HT-25	C-7	C-12	S-7	S-12		
ADC-44, ADC-66	C-12	C-24	S-12	S-24		PMG-100
BLAKESLEE						
UC-21A, UC-21B	C-4	C-4	S-6	S-6	PMG-100	PMG-100
UC-21	C-6	C-12	S-6	S-12	PMG-100	PMG-100
D-8	C-9	C-13	S-9	S-13	PMG-100	PMG-100
D-9	C-12	C-17	S-12	S-17	PMG-100	PMG-100
Series "R" & "F" -CC, -EE, -LL, -MM, -LLL, -MMM, -PCC, -PEE, -PLL, -PMM (multi-tank) with suffix "LC"	C-13	C-24	S-13	S-24	PMG-200	PMG-200/100
Series XF-EE, XF-LL	C-17	C-30	S-17	S-30	PMG-100	PMG-200
Series XF-LL, XF-PLL, XF-MM, XF-PMM, XF-EEE, XF-LLL, XF-MMM (Multi-tank) with suffix "LC"	C-17	C-30	S-17	S-30	PMG-200	PMG-200/100
DD-8	C-18	C-30	S-18	S-30	PMG-100	PMG-200
Series F-E, FA-EE, FA-PEE, FA-LL, FA-PLL, FA-MM, FA-PMM, F-EEE, FA-EEE, FA-LLL, FA-MMM, F-PE	C-30	C-54	S-30	S-54	PMG-200	PMG-200/100
Series R-L, R-PL, R-M, R-PM, F-L, F-PL, F-M, F-PM (single tank)	C-36	C-54	S-36	S-54	PMG-200	(2)PMG-200
Series XF-L, XF-PL, XF-M, XF-PM (single tank)	(2)C-36		(2)S-36			
Series R-E, R-PE, XF-PEE, XF-PLL, XF-PMM, XF-EEE, XF-LLL, XF-MMM (multi-tank) FA (Flight-A-Round) and RA (Rack-A-Round) use comparable "F" listing.	C-45	(2)C-30	S-45	(2)S-30	PMG-200	(2)PMG-200
XF-EE, XF-EE-LT (with LT suffix)	C-17	C-36	S-17	S-36	PMG-100	PMG-200
CHAMPION						
U-H1, UH-200, UH-200B, U-HB	C-4	C-6	S-6	S-6	PMG-100	PMG-100
UL-100, UH-100B, UH-170B, UH-200B, DH-2000	C-6	C-9	S-6	S-9	PMG-100	PMG-100
UL-150	C-4	C-7	S-6	S-7	PMG-100	PMG-100
UH-150, UH-150B, UH-100, UH-100B, DHB-VS	C-5	C-9	S-6	S-9	PMG-100	PMG-100
D-H1, D-HB, D-H1T, D-HBT	C-9	C-13	S-9	S-13	PMG-100	PMG-100
44 DRWS, 66 DRPWWS, 80 DRHDPWWS, 70 DRFFPWWS	C-9	C-13	S-9	S-13	PMG-100	PMG-100
PP-28	C-27	C-45	S-27	S-45	PMG-100	PMG-200
D-H1C, D-H1TC	C-9	C-18	S-9	S-18	PMG-100	PMG-100
DL-1000, DH-1000, DHB-VS	C-6	C-12	S-6	S-12	PMG-100	PMG-100
44DR, 66DRPW, 80DRHDFW, 70DRFFPW, 54DR, 76DRPW, 80DRFFPW, 90DRHDPW	C-12	C-24	S-12	S-24	PMG-100	PMG-100
44-WS, 66 WSPW, 66-WS, 64, 70WSFFPW, 80WSHDPW, 90FFPW, 100HDPW, 86 PW, 84, 106 PW, 120 HDPW, 110 FFPW	C-15	C-24	S-15	S-24	PMG-100	PMG-100
UC-CW6-WS	C-24	C-36	S-24	S-36	PMG-100	PMG-200
US-CW8-WS	C-24	C-39	S-24	S-39	PMG-100	PMG-200
44, 66 PW, 70FFPW, 80HDPW	C-27	C-54	S-27	S-54	PMG-100	PMG-200
54, 76PW, 80FFPW, 90HDPW,	C-24	C-45	S-24	S-45	PMG-100	PMG-200
40-KB, 40-KB-2-2, 40-KFWB, 40-KPRB, 40-KPRB-2-2, 40KPRB-2-3, 44LT, 60-KB, 60-KB-2-2, 60-KFWB, 60-KFWB-2-2, 60-KPRB, 60-KPRB-2-3, 64KB, 64-KB Corner, 64-KPRB, 64-KPRB Corner, 64 Modular, 66LT, 86 Modular	C-30	C-54	S-30	S-54	PMG-200	PMG-200/100
44-KB, 44-KB Corner, 44-KPRB, 44-KPRB Corner, 54-KB, 54-KB Corner, 54-KPRB, 54-KPRB Corner, 44 Modular, 66 PW Modular, UC** Series 6' Center, UC-C4	C-36	C-57	S-36	S-57	PMG-200	PMG-200/100
UC-CW4	C-36	(2)C-36	S-36	(2)S-36	PMG-200	PMG-200/100
UC-C	C-45	(2)C-36	S-45	(2)S-36	PMG-200	PMG-200/100
UC**CW Series 6' Center	C-45	(2)C-39	S-45	(2)S-39	PMG-200	(2)PMG-200
W-6-WS, W6	C-45	(2)C-45	S-45	(2)S-40	PMG-200	(2)PMG-200

□ Powermite installations above 2,000 ft. will reduce the above capacities and may require change of pressure and/or orifices in certain models at time of install to meet IAS safety compliance. These modifications are the responsibility of the installer. Consult "Installation and Operating Manual" for sizing adjustments and orifice changes.



Booster Heater Sizing Chart

Dishwasher Model Number	Electric Compact Booster Temperature Rise		Electric Imperial Booster Temperature Rise		Gas Powermite® Booster Temperature Rise	
	40°F	70°F	40°F	70°F	40°F	70°F
CMA DISHMACHINES						
AH, C, B ^o	C-9					
CMA-180	C-5	C-9	S-5	S-9		
CMA-180T	C-9	C-13	S-9	S-13		
CMA-44/66	C-24	C-36	S-24	S-36	PMG-100	PMG-200
CMA-44H with tank heater, CMA-66H	C-36	C-45	S-36	S-45	PMG-100	PMG-200
EAH/EC ^o , GLX/L1X/L1X16/L1C	C-4					
EST ^o	C-5					
EST-44/66	C-12	C-24	S-12	S-24	PMG-100	PMG-100
HOBART						
AM-15F	C-4	C-6	S-6	S-9	PMG-100	PMG-100
LXiC, LXiGC, LX-18C, LX-30C, LX-40C, AM-15F	C-4	C-7	S-6	S-6	PMG-100	PMG-100
LX-30, SR24, SR24H	C-4	C-7	S-6	S-7	PMG-100	PMG-100
LX-18, AM-14F, AM-15, AM-15T	C-5	C-9	S-6	S-9	PMG-100	PMG-100
WM-5C	C-6	C-9	S-6	S-9		PMG-100
WM-5 (Without sump heater)	C-7	C-12	S-7	S-12		
AM-14T, AM-14TC	C-7	C-12	S-7	S-12	PMG-100	PMG-100
AM-14, AM-14C	C-9	C-17 or C-18	S-9	S-17 or S-18	PMG-100	PMG-100
AM-12, AM-12C*	C-9	C-12	S-9	S-12	PMG-100	PMG-100
UW-50			S-15	S-24		
^{OR} Opti-RinSe C44A, CRS-66A, CCS-66A, CPW-80A, C54A, CRS-76A, CCS-76A, CPW-90A, C64A, CRS-86A, CCS-86A, CPW-100A, C88A, CRS-110A, CCS-11-0A, CPW-124A	C-15	C-27	S-15	S-27	PMG-100	PMG-200
C-54A, CRS-76A, CPW-90A, CCS-76A	C-39	(2)C-36	S-39	(2)S-36	PMG-200	PMG-200/100
C-44A, CRS-66A, CCS-66A, CPW-80A, C-64A, CRS-86A, CCS-86A, CPW-100A	C-30	C-54	S-30	S-54	PMG-200	PMG-200/100
C-88A, CRS-110A, CPW-124A, CCS-110A	C-36	C-54	S-36	S-54	PMG-200	PMG-200/100
Opti-RinSe C44AW, CRS-66AW, CCS-66AW, CPW-80AW	C-9	C-15	S-9	S-15	PMG-100	PMG-100
^{OR} C-44AW, CRS-66AW, CPW-80AW, CCS-66AW	C-12	C-24	S-12	S-24	PMG-100	PMG-100
C-44, CRS-66, CPW-80	C-36	C-54	S-36	S-54	PMG-200	PMG-200/100
CL44e, CL66e	C-13	C-24	S-13	S-24	PMG-100	PMG-200
CLPS66e	C-15	C-30	S-15	S-30	PMG-100	PMG-200
C-54, CRS-76, CPW-90	C-54	(2)C-39	S-54	(2)S-39	PMG-200/100	(2)PMG-200
C-64W, CRS-86W, CPW-100W, C-88W, CRS-110W, CPW-124W, CCS-86W	C-24	C-36	S-24	S-36	PMG-100	PMG-200
C-64, CRS-86, CPW-100	C-45	(2)C-36	S-45	(2)S-36	PMG-200	PMG-200/100
FT800W, FT-900W	C-24	C-39	S-24	S-39	PMG-200	PMG-200
FT-600, FT-700	C-54	(2)C-39	S-54	(2)S-39	PMG-200/100	(2)PMG-200
FT800	C-39	(2)C-39	S-39	(2)S-39	PMG-200	(2)PMG-200
FT900	C-36	C-57	S-36	S-57	PMG-200	PMG-200/100
FT800S, FT-900S	C-39	(2)C-36	S-39	(2)S-36	PMG-200	PMG-200/100
UTW-28, UTW-28C			S-18	S-36		
FRC and FR (Fast Rack Series) use comparable "C" line listing.						
INSINGER						
GS 302, GS-14	C-4	C-4	S-6	S-6	PMG-100	PMG-100
45SA-5	C-9	C-18	S-9	S-18	PMG-100	PMG-100
Commander 18-5 Series, CS-5, CS-5C, CS-5CH, CS-5H, Ensign 40-2	C-6	C-12	S-6	S-12	PMG-100	PMG-100
Commander 18-6 Series, 18-6H	C-6	C-12	S-6	S-12	PMG-100	PMG-100
Commander 18-6, 18-6H (Built-In)	ABB-13.5	ABB-13.5				
Admiral 44-4, 66-4, Speeder 64, 86-3, Clipper (all)	C-15	C-27	S-15	S-27	PMG-100	PMG-200
Admiral 44-4, 66-4 (Built-In)	ABB-15-8	ABB-27-8				
135-20, 185-20, 250-20, 60-20, 85-20, Gallymaster & Modular Century (all)	C-54		S-54			PMG-200
Trac 878	C-24	C-45	S-24	S-45	PMG-100	PMG-200
Super 106-2, Trac 321, Trac 321-2/RPW	C-24	C-36	S-24	S-36	PMG-100	PMG-200
Defender Flight Machine	C-27	C-45	S-27	S-45	PMG-100	PMG-200
Master RC 3-tank Flight Machine	C-36	C-54	S-36	S-54	PMG-200	(2)PMG-200
Master RC 4-tank Flight Machine	C-15	C-27	S-15	S-27	PMG-200	(2)PMG-200
CA-3 [♦]	C-36	C-57	S-36	S-57		
DA-3 [♦]			S-9	S-24	PMG-200	
			(2)S-9	(2)S-24		
For outdated models, consult factory for correct booster.						

* Model AM-12 with serial no. 12-067-357 or below and model AM-12C with serial no. 12-067-537 or below require slightly larger booster than listed.

^o All cycles.

^{OR} C Models with serial no. 85-1041605 or greater use Opti-RinSe.

■ Shaded area indicates older models prior to Opti-RinSe.

▣ Powermite i nstallations above 2,000 ft. will reduce the above capacities and may require change of pressure and/or orifices in certain models at time of install to meet IAS safety compliance. These modifications are the responsibility of the installer. Consult "Installation and Operating Manual" for sizing adjustments and orifice changes.

♦ Consult factory – special plumbing may apply.



Booster Heater Sizing Chart

Dishwasher Model Number	Electric Compact Booster Temperature Rise		Electric Imperial Booster Temperature Rise		Gas Powermite® Booster Temperature Rise	
	40°F	70°F	40°F	70°F	40°F	70°F
JACKSON						
JP-24, JP-24B, JP-24F, JP-24BF	C-4	C-6	S-6	S-6	PMG-100	PMG-100
24B Series		C-4		S-6		PMG-100
10AB, 10APRB		C-5		S-6		PMG-100
44CE, 66 CERPW	C-30	C-54	S-30	S-54	PMG-200	
54CE, 76 CERPW	C-36	(2)C-30	S-36	(2)S-30	PMG-200	
64CE, 86 CERPW	C-27	C-39	S-27	S-39	PMG-200	
100	C-12	C-24	S-12	S-24	PMG-100	
100B, 100PRB, 150B, 150PRB		C-9		S-9		
150	C-12	C-18	S-12	S-18		PMG-100
200	C-7	C-12	S-7	S-12	PMG-100	PMG-100
200B		C-6		S-6		PMG-100
Tempstar GPX						PMG-100
Tempstar, Tempstar SDS, Tempstar HH	C-6	C-12	S-6	S-12	PMG-100	PMG-100
TS-44, TS-66	C-24	C-36	S-24	S-36	PMG-100	PMG-200
AJ-44, AJ-66, AJ-80, WH-44, ES-4400, ES-6600 (ECOLAB/JACKSON)	C-24	C-45	S-24	S-45	PMG-100	PMG-200
AJ-54, AJ-76, AJ-90	C-30	C-54	S-30	S-54	PMG-200	PMG-200/100
AJ-64, AJ-86, AJ-100	C-24	C-39	S-24	S-39	PMG-100	PMG-200
* Model #44CE w/SN1999 or below requires larger booster than listed.						
KNIGHT EQUIPMENT LTD.						
KLE-112-HL	C-7	C-12	S-7	S-12	PMG-100	PMG-100
MEIKO						
K-44, K-66, K-80	C-24	C-36	S-24	S-36	PMG-100	PMG-200
K-54, K-76, K-90, K-64, K-86, K-100	C-24	C-45	S-24	S-45	PMG-100	PMG-200
METALWASH/INTEDGE						
FW4	C-12	C-18	S-12	S-18	PMG-100	PMG-100
RS-30A, RS-28L			S-15	S-24		
RT-74, RT-60, RT-42B, RT-42BC			S-27	S-40		
RS-2R			S-30	S-45		
STERO						
ER-44, ER-44-10, ER-66S, ER-76S, ER-76SC	C-15	C-24	S-15	S-24	PMG-100	PMG-100
ER-64, ER-86S, ER-94S, ER-94SC	C-15	C-24	S-15	S-24	PMG-100	PMG-100
SCT-44-10-LW, SCT-44-LW, SCT-66S-LW, SCT-76S-LW, SCT-76SC-LW, SCT-90S-LW	C-15	C-24	S-15	S-24	PMG-100	PMG-100
SC-1-2-4-LW, SC-1-6-4-LW, SC-2-4-LW, SC-5-2-4-LW, SC-5-6-4-LW, SC-6-4-LW	C-15	C-24	S-15	S-24	PMG-100	PMG-200
SCT-64, SCT-86S, SCT-94S, SCT-94SC	C-24	C-45	S-24	S-45	PMG-100	PMG-200
SCT-108S, SCT-108SC, SCT-76, SCT-94SM	C-30	C-54	S-30	S-54	PMG-200	PMG-200/100
SC-6-4, SCT-44, SCT-44-10, SCT-66S, SCT-76S, SCT-76SC, SCT-90S	C-36	C-54	S-36	S-54	PMG-200	PMG-200/100
SCT-120S, SCT-120SC, SCT-120SM, SCT-150SM	C-36	C-57	S-36	S-57	PMG-200	PMG-200/100
STW-110, SC-1-2-7-4, SC-1-6-3-4, SC-1-6-7-4, SC-2-7-4, SC-5-2-7-4, SC-5-6-3-4, SC-5-6-7-4, SC-6-3-4, SC-6-7-4	C-30	C-54	S-30	S-54	PMG-200	PMG-200/100
SC-1-2-4, SC-1-6-4, SC-2-4, SC-5-2-4, SC-5-6-4	C-36	(2)C-57	S-36	(2)S-57	PMG-200	(2)PMG-200
SCT-44-10-SC-1-3-4, SCT-44-10-3-4, SCT-44-SC-1-3-4, SCT-44-SC-3-4, SCT-54-SC-1-3-4, SCT-54-SC-3-4, SCT-76S-SC-3-4	C-36	C-54	S-36	S-54	PMG-200	(2)PMG-200
STPC (Four tank)	C-24	C-45	S-24	S-45	PMG-100	PMG-200
STPCW (Four tank)	C-27	C-45	S-27	S-45	PMG-100	PMG-200
STPC	C-30	C-54	S-27	S-54	PMG-200	PMG-200/100
STPCW	C-36	(2)C-30	S-36	(2)S-30	PMG-200	PMG-200/100
SD-2RA, SDRA, SDRA-PACK	C-12	C-18	S-12	S-18	PMG-100	PMG-100
U-31-A, U-31-AC			S-24	S-45	PMG-100	PMG-200
U-31-A2			(2)S-24	(2)S-45	PMG-200	(2)PMG-200
STBUW-1	C-45	(2)C-36	S-45	(2)S-36		
SC-2-3-4, SC-5-2-3-4	C-30	C-45	S-30	S-45	PMG-200	
SC20-1 (low temp.)	C-12		S-12		PMG-100	
SC20-2 (low temp.)	C-12	C-24	S-12	S-24		PMG-100
SC-2-8, SC-2-9, SC-1-2-8, SC-5-6-8, SC-6-8, SC-6-9, SC-1-6-8, SC-5-6-9, SC-5-2-9, SC-1-6-9, SC-5-2-8 (low temp.)	C-18	C-36	S-18	S-36	PMG-100	PMG-200

Powermite installations above 2,000 ft. will reduce the above capacities and may require change of pressure and/or orifices in certain models at time of install to meet IAS safety compliance. These modifications are the responsibility of the installer. Consult "Installation and Operating Manual" for sizing adjustments and orifice changes.

This selector chart is based on 40°F and 70°F temperature rises, 20 psi flow pressure, and minimum rinse cycle timer setting in NSF listing.

All booster heaters are rated at 100% of the capacity of the dishwashers as recommended by the National Sanitation Foundation. Where make-up water for wash tank is provided from final rinse supply, chart recommendations are based upon this additional demand (not over 2 GPM) as required by NSF.

All sizings shown are that of the dishwasher manufacturers. Hatco Corporation is not responsible for incorrect sizing applications.

BOOSTER HEATER SIZING FORMULA

$$\left(\frac{\text{GPH} \times \text{°F Temp. Rise}}{400} = \text{KW} \right)$$

NOTE: GPH is gallons per hour.



Electrical Ratings For Hatco Water Heaters

Watts	Volts	Phase	Amps	Breaker or Fuse size
4kW	208	1	19	30
	240	1	17	30
	480	1	8	15
5kW	208	1	24	30
	240	1	21	30
	480	1	10	15
6kW	208	1	29	40
	208	3	25 ^Δ	40
	240	1	25	40
	240	3	22 ^Δ	30
	480	3	11 ^Δ	15
7kW	600	3	5.7	15
	208	1	34	50
	208	3	29 ^Δ	40
	240	1	29	40
	240	3	25 ^Δ	40
9kW	480	3	13 ^Δ	20
	600	3	6.7	15
	208	1	43	60
	208	3	38 ^Δ	50
	240	1	38	50
9.9kW	240	3	33 ^Δ	50
	480	3	16.3 ^Δ	30
	600	3	8.7	15
10.4kW	208	1	47.5	60
	208	3 (BAL.)	27.5	40
11.4kW	208	3 (BAL.)	28.8	40
	240	1	47.5	60
12kW	240	3 (BAL.)	27.5	40
	480	3 (BAL.)	13.7	20
	208	1	58	90
	208	3	33	50
	240	1	50	70
13.5kW	240	3	29	40
	480	3	14.5	20
	600	3	11.6	20
	208	1	65	90
	208	3	38	50
15kW	240	1	56.3	90
	240	3	33	50
	480	3	16.3	30
	600	3	13	20
	208	1	72	90
17.25kW	208	3	41.7	60
	208	1	62.5	90
	240	1	62.5	90
	240	3	36.1	50
	480	3	18.1	30
18kW	600	3	14.5	20
	208	3	47.9	60
	208	1	86.5	125
	240	1	75	100
	240	3	43.4	60
	480	3	21.7	30
	600	3	17	30

Watts	Volts	Phase	Amps	Breaker or Fuse size
24kW	208	1	115.4	150
	208	3	66.7	90
	240	1	100	125
	240	3	57.8	90
	480	3	29.9	40
27kW	600	3	23.2	30
	208	1	129.8	175
	208	3	75	100
	240	1	112.5	150
	240	3	65	90
30kW	480	3	32.5	50
	600	3	26.1	40
	208	1	144	200
	208	3	83.3	125
	240	1	125	175
36kW	240	3	72.3	100
	480	3	36	50
	600	3	29	40
	208	1	173	225
	208	3	100	125
39kW	240	1	150	200
	240	3	86.7	125
	480	3	43.3	60
	600	3	34.8	50
	208	1	187.5	250
40.5kW	208	3	108	150
	240	1	163.5	225
	240	3	94	125
	480	3	47	60
	600	3	37.7	50
45kW	208	3	112.5	150
	240	3	97.5	125
	480	3	48.8	70
	600	3	39	50
	208	3	125	175
54kW	240	1	188	250
	240	3	108	150
	480	3	54	70
	600	3	43.5	60
	208	3	150	200
57kW	240	3	130	175
	480	3	65	90
	600	3	52.1	70
	208	3	158.4	200
	240	3	137.3	175
	480	3	68.6	90
	600	3	54.9	70

Δ Open Delta (unbalanced load) amperage of high leg indicated.

USE COPPER WIRE ONLY

ELECTRICAL FORMULAS

Watts = Amps
Volts 1-phase

Watts x .86 = Amps
Volts 3-phase
(open delta)

Watts = Amps
Volts x 1.73 3-phase
(balanced delta)



Food Pans & Trivets



PIZZA PANS
14\"/>



ST PANS
ST PAN 1/3
ST PAN 1/2
ST PAN 2
ST PAN 4

FOOD PANS

Model	Description	List Price
ALUM PAN	Half-Size Sheet Pan – 18"W x 13"D	\$ 55
18"SHEET PAN	Full-Size Sheet Pan – 18"W x 26"D	77
14"PIZZA PAN	Perforated Pizza Pan – 14" Diameter	59
16"PIZZA PAN	Perforated Pizza Pan – 16" Diameter	67
18"PIZZA PAN	Perforated Pizza Pan – 18" Diameter	72
ST PAN 1/3	Third-Size Stainless Steel Pan – 12 ³ / ₄ "W x 6 ⁷ / ₈ "D x 2 ¹ / ₂ "H	101
ST PAN 1/2	Half-Size Stainless Steel Pan – 12 ³ / ₄ "W x 10 ³ / ₈ "D x 2 ¹ / ₂ "H	116
ST PAN 2	Full-Size Stainless Steel Pan – 12 ³ / ₄ "W x 20 ³ / ₄ "D x 2 ¹ / ₂ "H	138
ST PAN 4	Full-Size Stainless Steel Pan – 12 ³ / ₄ "W x 20 ³ / ₄ "D x 4"H	174



HDW TRIVET



HDW-SPLASH



HDW 6" PAN

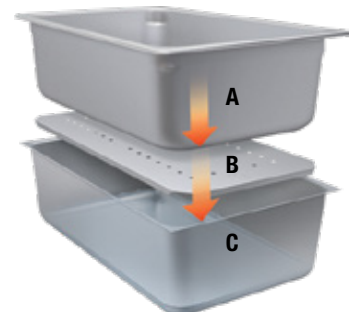

Additional Humidity

- A. Stainless Steel Food Pan
- B. Splash Baffle
HDW-SPLASH Accessory
- C. Water/Spillage Pan (adds 1/4" of water)
HDW-SPILL Accessory

FOOD PANS AND TRIVETS

Model	Description	List Price
HDW TRIVET	Custom Trivet raises food product 1/2" off bottom of Full-Size Pan - 17 ¹ / ₂ " x 9 ¹ / ₂ " x 1/2"	\$103
HDW-SPILL	Water/Spillage Pan – one per drawer (excludes HDW-1R2, -2R2)	456
HDW-SPLASH	Splash Baffle – one per drawer (excludes HDW-1R2)	96
HDW 6" PAN	Full-Size Stainless Steel Food Pan 12 ³ / ₄ "W x 20 ³ / ₄ "D x 6"H	187

FOOD PANS AND TRIVETS

Model	Description	List Price
Wire Trivets Stainless –		
TRIVET (1/2)SS	Half-Size – 10 ³ / ₁₆ "W x 7 ⁵ / ₈ "D	\$186
TRIVET SS	Full Size – 10 ¹ / ₈ "W x 18"D	259

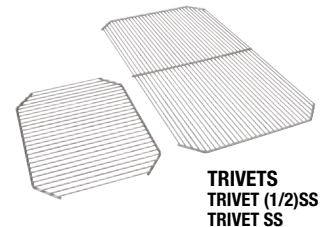

TRIVETS
TRIVET (1/2)SS
TRIVET SS



Paint Chip and Stone Sample Colors

DESIGNER COLORS



Warm Red



Black

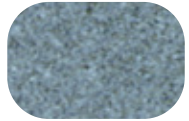

Gray Granite



White Granite



Navy Blue



Hunter Green



Antique Copper

GLOSS FINISHES



Smooth White



Gleaming Gold



Glossy Gray



Bold Black



Radiant Red



Brilliant Blue



Clear Brushed Metal Finish

PLATED FINISHES



Bright Brass



Bright Nickel



Bright Copper



Antique Nickel



Antique Brass



Antique Bronze

SIMULATED STONE COLORS**



Gray Granite



Bermuda Sand

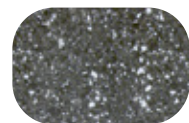

Night Sky

DEKTON STONE** COLORS



Domoos

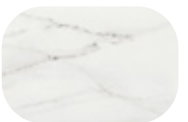

Rem



Soke

Colors are a representation and may not exactly match our colors.
Consult factory for possible color matching options on these colors.
Non-standard colors are non-returnable.

To order a Hatco Paint Chip & Stone Sample Colors Sheet, visit www.hatcocorp.com / Order Literature / Sales Literature / Sell Sheets.

* Simulated stone is Swanstone®

** Due to the natural texture, patterns may vary.

☞ Our current Swanstone simulated stone options — Bermuda Sand, Gray Granite and Night Sky — will be discontinued at the end of 2025. We will introduce new Swanstone simulated stone options on January 1, 2026.



General Information

Terms of Sale: EX Works

Sturgeon Bay, WI 54235 U.S.A.

Corporate Office: Milwaukee, Wisconsin 53215

Manufacturing: Sturgeon Bay, Wisconsin 54235

Price Policy: Prices supercede all previously published prices and are subject to change without notice. Prices and discounts apply to accessories at time of initial equipment order only.

Remittance: Forward payment in Canadian dollars to:

Hatco Corporation
P.O. Box 2435 Station A,
Toronto, Ontario M5W 2K6
Canada

Delivery: Consult Hatco Equipment Sales Department for delivery times and estimated shipping charges.

Freight Classification: See Hatco website for more details:

www.hatcocorp.com
Under the RESOURCES tab in the upper right-hand corner, click on EQUIPMENT SHIPPING INFORMATION

Business Hours:

Equipment Sales & Customer Service

7:00 a.m. to 5:00 p.m. Central Time

General Office

8:00 a.m. to 5:00 p.m. Central Time

Summer Hours – June through September:

Equipment Sales & Customer Service

7:00 a.m. to 5 p.m. Central Time, Monday through Thursday

7:00 a.m. to 4:00 p.m. Central Time, Friday

General Office

8:00 a.m. to 5:00 p.m. Central Time, Monday through Thursday

8:00 a.m. to 2:30 p.m. Central Time, Friday

Sales catalogs, brochures, specification sheets and other literature available at www.hatcocorp.com.

ALL HATCO PRODUCTS SHIPPED WITH INSTALLATION AND OPERATING INSTRUCTIONS. CONSULT LOCAL CODES BEFORE INSTALLING EQUIPMENT.

E-mail inquiries and requests to: support@hatcocorp.com

E-mail orders to: intlsales@hatcocorp.com

Telephone: Equipment Orders & Inquiries: (414) 671-6350

General Office: (414) 671-6350

www.hatcocorp.com

Conversions

Watts ÷ Volts = Amps (Single Phase only)

Inches x 25.4 = Millimeters

Pounds ÷ 2.2 = Kilograms or Pounds x .4536 = Kilograms

(°Fahrenheit - 32) x .56 = °Celsius

Gallons ÷ .264 = Liters or Gallons x 3.7853 = Liters

Water Quality Requirements

Water supply in excess of 3.0 grains of hardness per gallon (GPG) must be treated and softened before being used. Water containing over 3.0 GPG will decrease the efficiency and reduce the operating life of the unit.

NOTE: Product failure caused by liming or sediment buildup is not covered under warranty.

NOTE: See page 239 for Picture of Blended Phosphate Water Treatment System.

Hatco products are manufactured for commercial use only and meet one or more of these agency certifications.



See product specification sheet for the appropriate approvals.

120 Volt Models

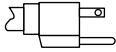

NEMA 5-15P



NEMA 5-20P

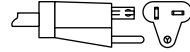

NEMA 5-30P

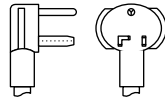

208 or 240 Volt Models



NEMA 6-15P



NEMA 6-20P

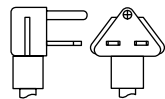

NEMA 6-30P

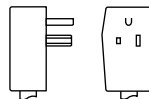

NEMA 6-50P

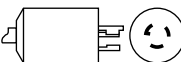

NEMA L6-20P

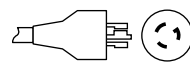

NEMA L6-30P



NEMA L14-20P

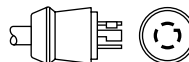

NEMA L15-30P

Limited Warranty

For the full information pertaining to the Hatco warranty protection for your equipment, go to our website at:

www.hatcocorp.com

Step 1: Make sure you have the correct region selected

Step 2: In the **Support** drop-down at the top of the page, select **Warranty**

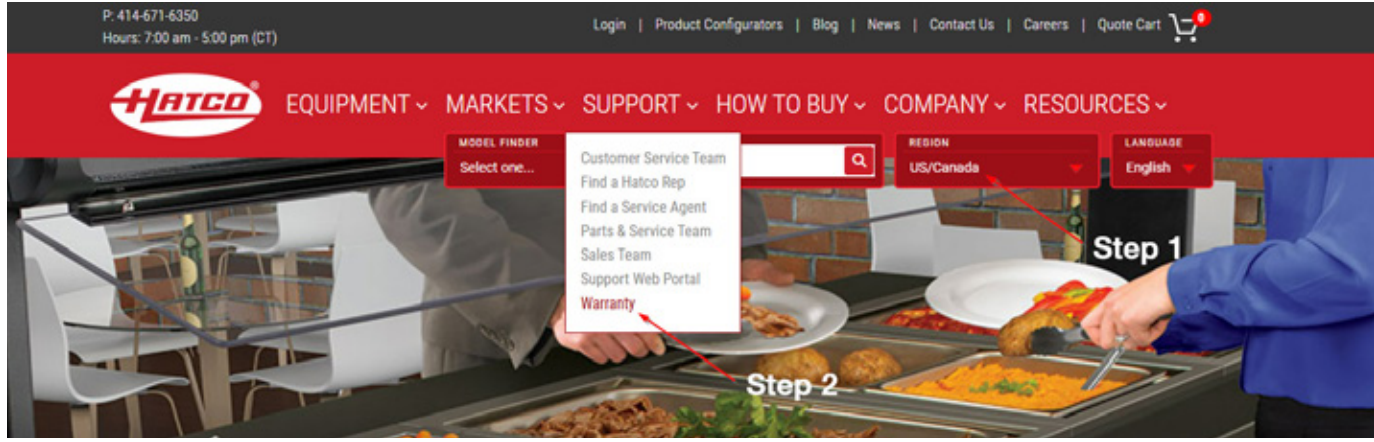

Ordering Procedures

CUSTOMER NOTE –

To ensure prompt and accurate processing of your order, please provide the following information:

ALL PRODUCTS –

1. Model number, voltage and phase.
2. Specify options and accessories as required. Options are not retrofittable.
3. Consult factory when ordering equipment for special applications.
4. Phone orders are acceptable, but a confirming written order is required. E-mail orders do not require confirmation.

Returns

New and unused equipment can only be returned for credit review with prior approval of the Hatco Corporation. Contact Customer Service or Sales Managers for a Material Return Authorization (MRA). Returns must be shipped PREPAID and are subject to inspection. All goods returned for customer convenience are subject to a restocking charge of 25%. In the event of an error by Hatco, an MRA will be issued for full credit. Custom-built equipment and equipment older than 120 days (from date of shipment) do NOT qualify for return credit. Flav-R 2-Go® Locker Systems (all models), Pickup Pod™ (all models), Decorative Lamps (all models), and Flav-R-Shield® Sneeze Guards (all models) are custom by nature and are non-returnable.

Contact Hatco for the return address.

Damaged Freight Policy

In accordance with the National Motor Freight Traffic Association, it is the consignee's responsibility to inspect and ensure the shipment has not sustained any damage during transportation to destination. All freight should be inspected during the receiving process for possible damage. Should there be a question about the condition of the equipment, it is very important that it is noted on the delivery receipt. If the damage is clear, it is better to refuse the shipment. If damage is found after delivery, it is the consignee's (receiver) responsibility to notify Hatco Corporation (notify the carrier if shipped third party) within **three (3) calendar days** from the date of delivery.

Whether the shipment was routed by a Hatco preferred carrier or customer selected third party carrier, Hatco will assist its customers in achieving a solution. If it is found that any part of the shipment has sustained damage during transportation, Hatco Corporation must be contacted to file a damage report.

For assistance, contact Hatco Customer Service at (414) 671-6350 and have the information listed below available.

1. Copy of Bill of Lading and Pro numbers
2. Delivery date, date damage was discovered and location of the unit
3. Contact name, phone number and email address
4. Model and serial number/s of the damaged unit/s
5. Extent of damage
6. Pictures of damage, as well as pictures of the packaging (DO NOT discard the packaging)

Accessorial Charges

When shipping LTL using a Hatco preferred carrier, additional fees known as accessorial charges may apply and will be added to order. Residential Delivery Fee, Construction Site Delivery Fee, Government Site Delivery Fee, and Limited Access Fee are all fees added automatically by the carrier based on where the order is shipping. The fee varies depending on the service, delivery location and carrier.

Liftgate is charged by the carrier if the consignee does not have a loading dock or a forklift onsite to unload the freight from the truck. Optional services available for an additional fee include Inside Delivery, Call before Delivery and Delivery by Appointment. Hatco must be made aware of any special services needed at the time of order or prior to shipment so the fee can be added to the original invoice, otherwise the fee will be post billed and a second invoice will be received for this charge.

**Fee amount varies by carrier.



Product Index

Resources

ORDER PICKUP STATIONS & FOOD LOCKERS	2-10
HEATED & COLD WELLS	11-50
HEATED & COLD SHELVES	51-87
SNEEZE GUARDS	88-92
STRIP HEATERS	93-126
DECORATIVE LAMPS & DISPLAY LIGHTS	127-136
FRY STATIONS	137-143
CARVING STATIONS & BUFFET WARMERS	144-150

DRAWER WARMERS	151-156
MERCHANDISERS & DISPLAY CASES	157-190
HOLDING CABINETS	191-199
TOASTERS	200-206
INDUCTION RANGES & WARMERS	207-214
LIGHT COOKING EQUIPMENT	215-221
WATER HEATING/SPECIALTY EQUIPMENT	222-239
FOOD PANS & TRIVETS	240

3CS	224	GR, GRH	100-101	HWBI-S	25-27, 39-40
3CS2	225	GR-B	141-142	HWBRN (UR)	28-29, 35-36, 39-40
AWD	223	GRA, GRAH	99, 101	HWBRT (UR)	28-29, 35-36, 39-40
C	230-231	GRA-xxD, GRAH-xxD	102, 104	HWBRN-xxQT (UR)	28-29, 37, 39-40
CDW	155	GRAL, GRAHL	100-101	HWBRT-xxQT (UR)	28-29, 37, 39-40
CHW	15, 39-40	GRAL-xxD, GRAHL-xxD	103-104	HXXMH, HXMS	168, 170
CSBFR, CSBFX	81	GRAIH, GRAIHL	117, 119	HZMH, HZMS	169-170
CSBFP	77	GRAIH-xxD, GRAIHL-xxD	118-119	IGRID	NEW 216
CSSBR, CSSBX	79	GRAM, GRAML	110-111	IHDCH	188-189
CSSBFR, CSSBFX	80	GRAM-xxD	112, 114	IRNG-BXC1	208
CSSBFP	76	GRAML-xxD	113-114	IRNG-HC1, -PC1, -PB1	209-211
CSSBP	75	GRBW	147-148	IRNG-PC2F, -PC2S, -PB2	212
CSUR, CSUX	82-83	GRCD, GRCDH	174-175	IWELB	16
CSUP	78	GRCMW	149	IWRM-C1, -CD1, -B1	213
CWBP, CWBP-S	41-43, 47	GRCSCCL, GRCSCCLH	146	IWRM-UT	214
CWBR, CWBX, CWBR-S, CWBX-S	44-47	GRFF, GRFFL, GRFFB, GRFFBL	141-142	IWB, IWB-S	48-50
DCS, DCSB2	NEW 145	GRFHS, GRFS	138-139	ITQ	205
DHWBI, DHWBI-S	17-20, 39-40	GRHD, GRHDH	177-178	LFST	187
DL, DLL, DLH	128-134	GRHW	150	LW	143
F2G, F2GB	5-6	GRN, GRNH	115	MC	229
F2GBOF, F2GBOB	NEW 4	GRNM	116	MDW	179
F2GP, F2GBP	7-8	GRPWS	161-162	MPP	10
FDWD-1-MN	185	GRS2G	3	MPP-xPT, -xHPT	9
FDWD	180, 183-184	GRS	55-57	MPWS	140
FR	226	GRSB	66-67	PDH	190
FR2	227	GRSBF	68	PFST	197
FS2HAC	198	GRSDH, GRSDS	164-165	PG14	NEW 218
FS3HAC	159-160	GRSDS/H	163	PMG	228
FS3RAC	NEW 158	GRSR	52, 54	PSH	190
FSCD, FSCDH	176	GRSS	58	PWB, PWC	199
FSD, FSDT	181-184	GRSSB	64	RHW	13
FSHAC, FSHACH	198	GRSSR, GRSSRxx-DL77516	53-54	RMB	126
FSHC-5W, -7W	192	HGB	59	RMB2	125
FSHC-6W	193	HGBG	65	RWM	220
FSHC-7	194	HCSBFR, HCSBFX	73-74	S	232-233
FSHC-12W, -17W	195-196	HCSSBR, HCSSBX	69-70	SAL	217
FST-1-MN	185	HCSBFR, HCSSBFX	71-72	SNACK	221
FTBP, FTBP-S	84-85	HCWBIR, HCWBIX	38-39	SNEEZE GUARDS	89-92
FTBR, FTBR-S, FTBX, FTBX-S	86-87	HDW	153-154	SWB, SWC	12
FWM	219	HDWTC	152	SW2	14, 39
GR2A, GR2AH	105, 107	HDW-xr2	153-154	TK	206
GR2A-xxD, GR2AH-xxD	108-109	HGSM	60	TPT	201
GR2AL, GR2AHL	106-107	HL	136	TQ	202-203
GR2AL-xxD, GR2AHL-xxD	108-109	HL5	135	TQ3	204
GR2BW	147-148	HRDW	156	UGA, UGAH	120, 122
GR2S	57	HSBF-GL, -HC, -SS	61-63	UGA-xxD, UGAH-xxD	121-122
GR2SDH, GR2SDS	166-167	HW	15, 39-40	UGAL, UGAHL	120, 122
GR3SDH, GR3SDS	171-172	HWB, HWBL, HWBH	28-32, 39-40	UGAL-xxD, UGAHL-xxD	121-122
GR3SDS-xxDCT, GR3SDS-xxTCT	173	HWB-xxQT, HWBI-xxQT	28-29, 33-34, 39-40	UGFF, UGFFL, UGFFB, UGFFBL	141-142
GR5A, GR5AH	96, 98	HWBI, HWBLI	21-23, 27, 39-40	WFST	186
GR5AL, GR5AHL	97-98	HWBI43	21, 24, 27, 39-40		



When you need equipment shipped sooner than our normal lead times, Hatco's Quick-Ship Program offers over 300 models of our most popular equipment, in various voltages, and accessories ready for immediate shipment (based on availability).

Program Details:

- Orders received before 12 PM (Noon) CT will be shipped the same day.
- Orders received after 12 PM (Noon) CT will be shipped the next business day.
- Standard pricing and discounts apply.
- Orders are shipped with Hatco's preferred LTL carriers (unless specified by the customer), Next Day Air or Expedited Freight (available on most items).
- All orders are subject to credit approval.
- Quantities ordered may impact availability.

How to Order:

1. Confirm models are currently available via the Quick-Ship Program.
2. Provide the model number(s), voltage(s), Hertz and phase. (All watt ratings are nominal; actual wattage may vary. Consult factory for more information.)
3. Specify accessories as required.
4. Reference "Quick-Ship" on your equipment order.
5. Send all equipment orders to intlsales@hatcocorp.com. (E-mail orders are acceptable and do not require confirmation.)

In AutoQuotes:

1. Select **Hatco Canada** in the left-hand tool bar.
2. Select **Category** or **Search** for product keywords.
3. Select **Quick-Ship** under Brands in the left-hand tool bar.
4. Add to your existing project or create a new project.



For additional information, email us at support@hatcocorp.com or call us at (414)-671-6350.



People who serve, products that solve.™